

PROJECT GEMINI

TECHNOLOGY AND OPERATIONS

Prepared by

James M. Grimwood and Barton C. Hacker
with Peter J. Vorzimmer

THE NASA HISTORICAL SERIES



Scientific and Technical Information Division
OFFICE OF TECHNOLOGY UTILIZATION
NATIONAL AERONAUTICS AND SPACE ADMINISTRATION
1969
Washington, D.C.

For sale by the Superintendent of Documents
U.S. Government Printing Office, Washington, D.C. 20402
Price \$2.75 (paper cover)
Library of Congress Catalog Card Number 68-62086

FOREWORD

Gemini was one of the early pioneering efforts in the developing space capability of this nation. The initiation of this program was timed to take advantage of the knowledge gained in our first series of manned space flights—Project Mercury. The Mercury program successfully demonstrated manned orbital flight. Perhaps more important it provided extensive information on how to build and fly spacecraft for the more complex missions yet to come. Drawing on this experience, the Gemini program was able to produce for its time a highly flexible space vehicle of considerable operational capability. These characteristics enabled a rapid expansion of American flight horizons.

The most significant achievements of Gemini involved precision maneuvering in orbit and a major extension of the duration of manned space flights. These included the first rendezvous in orbit of one spacecraft with another and the docking of two spacecraft together. The docking operation allowed the use of a large propulsion system to carry men to greater heights above Earth than had been previously possible, thereby enabling the astronauts to view and photograph Earth over extensive areas. Precision maneuvering was also employed during the very high speed reentry back to the surface of Earth, enabling accurate landings to be made. The length of our manned space flights was extended to as long as 14 days, a duration that has yet to be exceeded as of this writing, although this was accomplished about three years ago.

Of great general interest were the investigations of the operations of an astronaut outside the confines of his spacecraft, protected from the hard vacuum of space by his pressurized space suit. These extravehicular activities did in fact produce some difficulties, but, in the end, highly successful operations were conducted.

All of these activities have greatly contributed to expanding activities in space that we now have underway or will be forthcoming. In Apollo, the program involved with landing men on the lunar surface, the crews must be transported roughly 240,000 miles to the Moon and then back to Earth. This trip will take a week or more. The Apollo spacecraft must perform a rendezvous not near Earth but out at lunar distances in order for this mission to be successful. Once again, the astronauts must leave their spacecraft and, in their pressure suits, step out onto the lunar surface so that scientific exploration can be conducted. The fact that all of these things were initially demonstrated and then investigated further in a number of the Gemini missions greatly aids the development of the more difficult missions that we are about to undertake.

Perhaps the most significant aspect of the Gemini program was the manner in which the astronauts contributed to the success of each mission. In the flying of the spacecraft, in the management of the systems, in the overcoming of problems, and in the aid to attainment of important scientific and technological information, their presence enhanced greatly the success of the program.

PROJECT GEMINI: A CHRONOLOGY

They were backed up by a large and dedicated team of people here on the ground who designed, developed, and checked out the vehicles and controlled the flights. The Chronology presented herein as a factual presentation of events taken primarily from official documentation of the program. It, therefore, cannot reflect many of the "behind the scenes" activities so important to the conduct of a successful program involving exploratory endeavors. The high motivation to make the Gemini program work, the rapid reaction in overcoming difficulties, large and small, and the attention to detail are all factors contributing to the ten successful manned flights which provided nearly two thousand man hours of direct space flight experience.

CHARLES W. MATTHEWS
Deputy Associate Administrator
Office of Manned Space Flight

September 16, 1968

CONTENTS

	PAGE
LIST OF ILLUSTRATIONS.....	viii
INTRODUCTION.....	xiii
PART I--CONCEPT AND DESIGN.....	1
PART II--DEVELOPMENT AND QUALIFICATION.....	69
PART III--FLIGHT TESTS.....	173
APPENDICES.....	263
1. GEMINI PROGRAM FLIGHT SUMMARY DATA.....	264
TABLE A: General.....	264
TABLE B: Orbital Operations.....	266
TABLE C: Project Gemini Experiments.....	268
TABLE D: Extravehicular Activity on Gemini Missions.....	270
2. GEMINI PROGRAM AND MISSION OBJECTIVES.....	271
3. VEHICLE MANUFACTURING AND TESTING HISTORIES.....	277
TABLE A: Gemini Launch Vehicle.....	277
TABLE B: Gemini Target Vehicle.....	279
TABLE C: Gemini Target Launch Vehicle.....	280
TABLE D: Gemini Spacecraft.....	281
4. WORLDWIDE TRACKING NETWORK.....	282
5. COST OF GEMINI PROGRAM.....	283
6. NASA CENTERS AND OTHER GOVERNMENT AGENCIES PARTICI- PATING IN THE GEMINI PROGRAM.....	283
7. CONTRACTORS, SUBCONTRACTORS, AND VENDORS.....	284
8. U.S. MANNED SPACE FLIGHT RECORD, SUMMARY OF MERCURY AND GEMINI FLIGHTS.....	290
INDEX.....	291

LIST OF ILLUSTRATIONS

FIGURE	PAGE
Frontispiece	
First successful rendezvous	ii
1 Proposed mission for modified Mercury capsule	3
2 Early version of "lifting" Mercury capsule	5
3 Proposed version of one-man space station	6
4 Orbital operations requiring a rendezvous development program ..	8
5 Deployment sequence for Mercury paraglider	9
6 Interior arrangement for proposed two-man Mercury spacecraft ..	10
7 Adapter section of proposed two-man Mercury spacecraft	11
8 Proposed "Lunar Lander" for use with advanced Mercury space- craft: Artist's conception	12
9 Drawing of modified Titan II for launch of advanced Mercury ...	13
10 Launch schedule for final version of Mark II Project Development Plan	15
11 First publicly released illustration of Gemini spacecraft	20
12 Operating principle of General Electric fuel cell for Gemini	22
13 Early conception of rendezvous mission	23
14 Block diagram of Gemini environmental control system	25
15 General arrangement of liquid rocket systems in the Gemini spacecraft and typical thrust chamber assembly	26
16a Gemini flight trainer for crew training	28
16b Gemini docking trainer for crew training	28
17 Main elements of the radar rendezvous system on Gemini space- craft and Agena target vehicle	29
18 Block diagram of the attitude control and maneuvering electronics system of Gemini spacecraft	29
19 Gemini spacecraft landing gear for land landing with the para- glider	30
20 Ejection seats in the Gemini spacecraft: Artist's conception	31
21 Reactant supply system for Gemini fuel cells	33
22 Operation of the horizon sensor for Gemini spacecraft	33
23 Retrograde rocket system for the Gemini spacecraft	34
24 Gemini spacecraft communications system	35
25 Table showing communication functions during a mission	36
26 Inertial guidance system	37
27 General nomenclature of the Gemini spacecraft	38
28 Gemini spacecraft tracking aids	39
29 Block diagram of the Gemini spacecraft guidance and control system	40
30 Solid-propellant retrograde rocket motor	45
31 Parachute recovery system for the first Gemini spacecraft	46

LIST OF ILLUSTRATIONS

FIGURE	PAGE
32 Paraglider deployment sequence of events.....	48
33 Emergency parachute recovery system for half-scale paraglider flight test vehicle.....	49
34 "Off-the-pad" escape mode for aborted Gemini mission.....	50
35 Airborne systems functional test stand at Martin-Baltimore.....	52
36 Emergency parachute recovery system for full-scale paraglider flight test vehicle.....	54
37 Engineering mockup of Gemini spacecraft at McDonnell, St. Louis.....	57
38 Proposed layout of Gemini facilities at Cape Canaveral.....	58
39 Sequence of events for Gemini missions.....	59
40 Proposed sequence of events for first Gemini mission.....	60
41 The B. F. Goodrich partial-wear full-pressure suit for Gemini.....	64
42 Manned Spacecraft Center Gemini facilities at Cape Canaveral and Merritt Island Launch Area.....	65
43 Paraglider half-scale test vehicle being lifted by helicopter.....	66
44 Ten percent model of Gemini spacecraft used for wind tunnel testing at McDonnell.....	67
45 Consoles in tracking network remote stations.....	72
46 Gemini fuel cell stack.....	74
47 Titan II N-15 launch at Cape Canaveral.....	77
48 Ballute deployment.....	78
49 Assembly of Gemini launch vehicle fuel and oxidizer tanks for Stages I and II.....	81-82
50 Primary propulsion system of Gemini Agena target vehicle.....	88
51 "POGO" suppression equipment.....	93
52 Gemini Launch Vehicle 1 being tested in Martin's vertical test facility in Baltimore.....	95
53 Malfunction detection system showing interface with Gemini spacecraft.....	97
54 Preparation of Gemini ejection seat for a dynamic sled test.....	99
55 Reentry control system for Gemini Spacecraft No. 1.....	101
56 Preparation for a test run in the centrifuge at Johnsville, Pennsylvania.....	102
57 Paraglider full-scale test vehicle.....	105
58 Desert training for astronauts.....	106
59 Water impact test of the Gemini parachute recovery system.....	107
60 Proposed parasail landing system: Artist's conception.....	110
61 Gemini parachute recovery system operational sequence.....	112
62 Diagram of the Gemini launch vehicle Stage II engine.....	115
63 Instrumentation pallets for Gemini Spacecraft No. 1.....	116-117
64 Installation of right ballast pallet and instrumentation pallet in Gemini Spacecraft No. 1.....	118
65 Jump-testing the 36-inch ballute at El Centro, California.....	124
66 Sequence compatibility firing of both stages of Gemini Launch Vehicle 1.....	128
67 Interface between Gemini launch vehicle and spacecraft.....	130
68 Gemini Boilerplate 3A in the production area at McDonnell.....	132
69 Agena secondary propulsion system.....	134

PROJECT GEMINI: A CHRONOLOGY

FIGURE	PAGE
70 Electronic-electrical interference tests of Gemini-Titan 1.....	137
71 Parachute test vehicle.....	140
72 Configuration of the Gemini Agena target vehicle.....	144
73 Three basic rendezvous plans considered for the first rendezvous mission in Gemini.....	148
74 Special instrumentation pallets for Gemini Spacecraft No. 2.....	150
75 Unloading of Gemini Launch Vehicle 2 first stage at Cape Kennedy.....	152
76 Egress training in Galveston Bay.....	158
77 Gemini Launch Vehicle 3 undergoing final checks.....	159
78 Backup and prime crews for Gemini-Titan 3 at Rollout Inspection for launch vehicle: l. to r., Thomas P. Stafford; Walter M. Schirra, Jr.; John W. Young; and Virgil I. Grissom.....	160
79 Gemini network.....	161
80 Water egress training at Ellington Air Force Base, Texas.....	162
81 Gemini G4C extravehicular suit.....	163
82 Zero-G tests in a KC-135.....	164
83a Astronauts Grissom and Young in the Gemini mission simulator at Cape Kennedy.....	165
83b Technicians at consoles of the Gemini mission simulator at Cape Kennedy.....	166
84 Agena Target Vehicle program terminology.....	168
85 Gemini Launch Vehicle Stage I hydraulic system.....	169
86 Agena D 82 being modified to Gemini Target Vehicle 5002.....	171
87 Gemini G4C extravehicular suit with chest pack and umbilical.....	172
88 Gemini Spacecraft No. 3 being unloaded at Cape Kennedy.....	175
89 Simulated Off-the-Pad Ejection Test No. 13 at China Lake, California.....	178
90 Tracking network for the second Gemini mission.....	180
91 Gemini Launch Vehicle 5 erection at the vertical test facility, Martin-Baltimore.....	183
92 Agena target vehicle command and communication system locations.....	186
93 Gemini-Titan 3 on pad 19.....	187
94 Gemini Spacecraft No. 4 entering altitude chamber at McDonnell.....	188
95 Extravehicular activity practice in the altitude chamber at McDonnell.....	189
96 Astronauts Young and Grissom walking toward elevator on Pad 19.....	190
97 Gemini Spacecraft No. 3 being hoisted aboard recovery ship.....	191
98 Astronaut James A. McDivitt undergoing wet mock simulated launch.....	195
99 Hand-held maneuvering unit.....	196
100 Gemini Spacecraft No. 5 cleanup.....	197
101 Target docking adapter assembly.....	198
102a Launch vehicle erector tower being lowered.....	199
102b <i>Gemini-Titan 4</i> launch.....	200
103 <i>Gemini-Titan 4</i> extravehicular activity.....	201
104 Rendezvous evaluation pod in the equipment section of Gemini Spacecraft No. 5.....	204
105 Gemini 5 ingress practice.....	206

LIST OF ILLUSTRATIONS

FIGURE	PAGE
106 Agena target launch vehicle being delivered to final assembly area	207
107 Mission Control Center, Houston, during <i>Gemini 5</i> mission: left to right, Christopher C. Kraft, Jr.; Robert R. Gilruth; and George M. Low	209
108 Florida peninsula from <i>Gemini 5</i>	210
109 Gemini Spacecraft No. 7 in clean room at McDonnell	212
110 Gemini Spacecraft No. 8 in McDonnell's clean room	214
111a General arrangement of augmented target docking adapter	221
111b Augmented target docking adapter equipment	221
112 Mockup of augmented target docking adapter and Gemini spacecraft at McDonnell	222
113 Gemini VII crew walking toward elevator at pad 19	223
114 <i>Gemini VII</i> crew on deck of U.S.S. <i>Wasp</i> after recovery	224
115 Gemini Spacecraft No. 6 being hoisted at complex 19	225
116 Attempted launch and shutdown of Gemini VI-A	227
117 Houston Mission Control Center reaction to first rendezvous	228
118 Swimmers attaching cable to <i>Gemini VI-A</i> spacecraft after landing	228
119 Donning the astronaut maneuvering unit	234
120 Launch of Gemini Atlas-Agena target vehicle for <i>Gemini VIII</i> mission	236
121a Final stage of <i>Gemini VIII</i> and Gemini Agena target vehicle rendezvous	237
121b <i>Gemini VIII</i> and Agena in docked configuration	238
122 Demonstration of astronaut maneuvering unit	242
123 Augmented target docking adapter with shroud still attached	245
124 Gemini Launch Vehicle 11 Stages I and II arriving at complex 19	247
125 Gemini Atlas-Agena target vehicle for Gemini X at complex 14	249
126 Gemini XI spacecraft in the pyrotechnic installation building at Merritt Island Launch Area	250
127 <i>Gemini XI</i> astronaut returns to spacecraft hatch	254
128 View of India and Ceylon during the <i>Gemini XI</i> mission	255
129 <i>Gemini XI</i> during landing phase	256
130 <i>Gemini XII</i> astronaut with micrometeoroid package	259
131 Tethered operation during <i>Gemini XII</i>	260

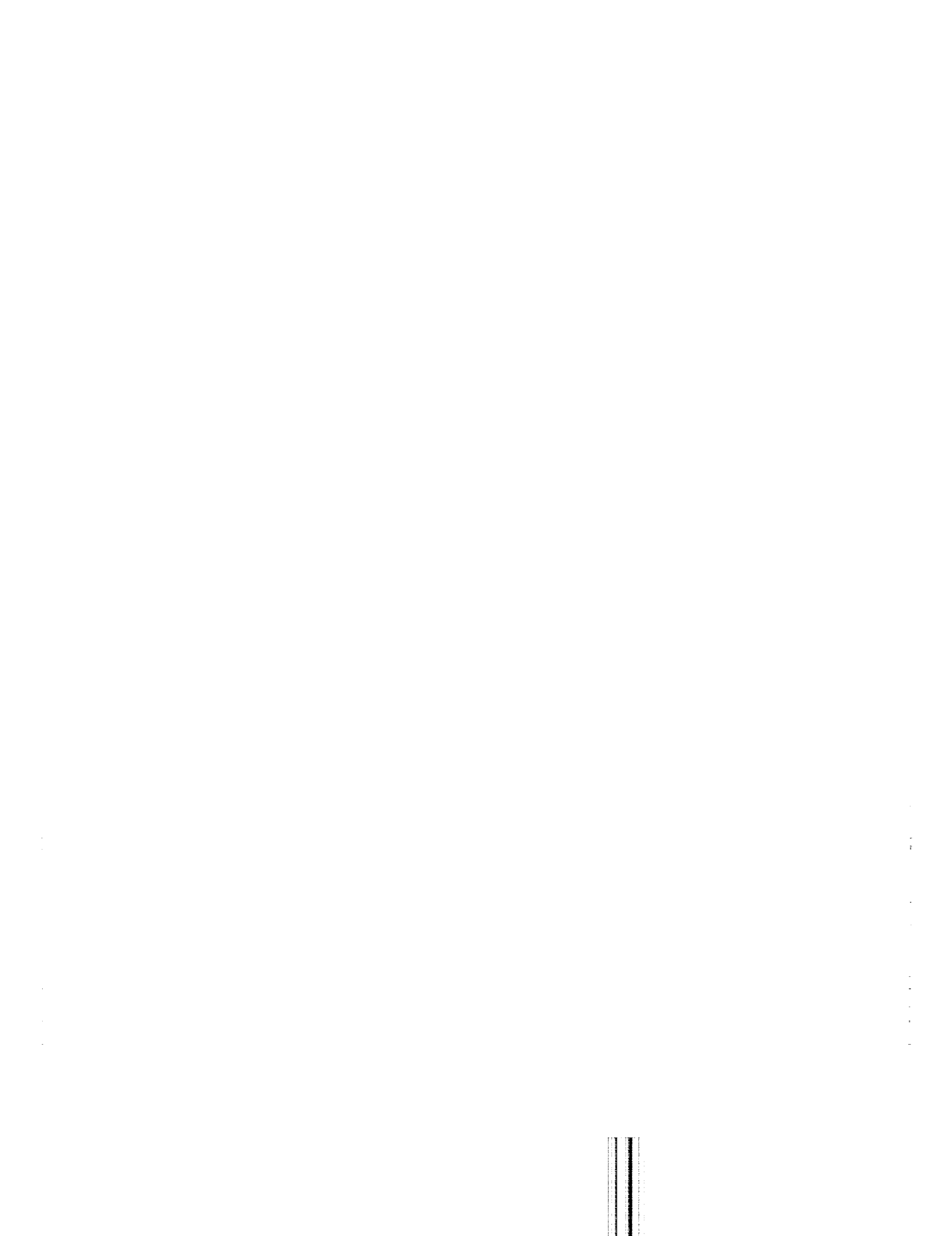

INTRODUCTION

This Chronology belongs to a broad historical program undertaken by the National Aeronautics and Space Administration to fulfill its statutory obligation to "provide for the widest practical and appropriate dissemination of information concerning its activities and the results thereof."¹ Project Gemini was the United States' second manned space flight program, a bridge between the pioneering achievement of Project Mercury and the yet-to-be realized lunar mission of Project Apollo. A history of Project Mercury has been written;² that of Project Apollo is still in the future.³ This Chronology, a step in preparing the history of Project Gemini, marks the completion of the first phase of our study of the Gemini program and lays the foundation for the narrative history that will follow. What we have done must stand as an independent work in its own right. But at the same time, some of its characteristics—in particular, what it contains and what it omits—can be properly justified only in terms of the larger whole of which it is a part.

We have deliberately focused this Chronology very narrowly, excluding much material of undoubted relevance to the background of events, the context of decision, and to other matters that might be characterized as the external environment of Project Gemini. In part this is the inevitable result of a chronological format, which leaves little scope for explaining and interpreting events. Equally important, however, was our decision to reserve for the less restricted confines of a subsequent narrative history our confrontation with the subtle problems of interpretation and causation, of controversy and cooperation, of individual achievements and failures in the Gemini program. Several major features of this text grew directly from this decision.

Our orientation throughout has been primarily institutional. Organizations rather than individuals are ordinarily the actors in events as we describe them. The point of view embodied in most of the entries is that of Gemini Program Office (the Manned Spacecraft Center element created to carry through the Gemini program) and of major Gemini contractors. The events that we have been most concerned to elucidate are technological—the engineering and developmental work which transformed the concepts and objectives of the Gemini program from idea to reality.

The technological orientation of this Chronology has imposed some burdens on its authors. Like other works in the NASA Historical Series, the Gemini

¹ "National Aeronautics and Space Act of 1958," Sec. 203 (a) (3).

² Loyd S. Swenson, Jr., James M. Grimwood, and Charles C. Alexander, *This New Ocean: A History of Project Mercury*, NASA SP-4201.

³ The first volume of a projected multivolume chronology of Project Apollo is: Ivan D. Ertel and Mary Louise Morse, *The Apollo Spacecraft: A Chronology*, Vol. I: *Through November 7, 1962*.

Chronology has been written for the informed, but not necessarily technically competent, layman. Its intended audience includes not only those professionally concerned with space programs, but also those with a more generalized interest in space activities. Accordingly, we have devoted special effort to explaining technical terms, supplementing the text with diagrams and photographs, describing test programs, and, in general, making Project Gemini comprehensible to readers who have no special knowledge of the events we discuss. This need not, we feel, impair the Chronology's value to the more technically sophisticated. Even within NASA and contractor organizations directly concerned with Project Gemini, few individuals could be familiar with every aspect of so large and complex an undertaking. We hope we have avoided the pitfall of belaboring what is obvious to the reader who knows the program while not explaining enough to the uninitiated.

Our attempt to achieve this goal has dictated, in part, that this Chronology be more than a mere list of dated events. Each entry is intended to be relatively independent and complete. One minor, though not insignificant, manifestation of this intent is that we have given all names, acronyms, and abbreviations in full upon their first appearance in every entry, with one exception: because its name is both ubiquitous and lengthy, we regularly refer to the National Aeronautics and Space Administration as NASA. A more important consequence of our attempt to write individually intelligible entries is that we have often combined several events under a single date. In doing this, we could naturally follow no hard and fast rules; what was or was not to be included in a single entry became ultimately a matter of judgment. To enable the reader to follow these judgments, which at times must appear somewhat arbitrary, we have provided a comprehensive index of the text.

This Chronology is fully documented, with sources for each entry in the text cited immediately after the entry. Our greatest, though not exclusive, reliance has been on primary sources. Of these, perhaps the most widely useful have been the various recurring reports issued by both NASA and contractor organizations. Foremost among these are the Project Gemini Quarterly Status Reports,⁴ the Manned Spacecraft Center weekly and monthly activity reports,⁵ and contractor monthly progress reports.⁶ Another extremely useful class of materials comprises nonrecurring reports and documents, such as working papers, technical reports, statements of work, mission reports and analyses,

⁴ Gemini Program Office issued 19 quarterly reports, the first covering the three months ending May 31, 1962; the last, the three months ending Nov. 30, 1966.

⁵ MSC Weekly Activity Report for the Office of the Director, Manned Space Flight; MSC Consolidated Activity Report for the Office of the Director, Manned Space Flight. Each report consisted of separate reports from major MSC elements, including Gemini Program Office.

⁶ These varied in format and usefulness. Of greatest value: Lockheed Missiles and Space Company, Gemini Agena Target Vehicle Program Progress Reports for the months September 1964 through November 1966 (LMSC-A605200-1 through -27); North American Aviation, Inc., Space and Information Systems Division, Contract NAS 9-167, Paraglider Development Program, Phase II, Part A, Monthly Progress Letters Nos. 1-16 for Nov. 20, 1962, through Mar. 31, 1963; *idem.*, Contract NAS 9-539, Paraglider Development Program, Advanced Trainer and Prototype Wing Design, Phase II, Part B(1), Monthly Progress Letters Nos. 1-9 for June 20, 1962, through Mar. 31, 1963; *idem.*, Contract NAS 9-1484, Paraglider Landing System Program, Monthly Progress Reports Nos. 1-21 for the months May 1963 through January 1965.

familiarization manuals, and final reports.⁷ The third major body of sources consists of the records of various NASA organizations, particularly Gemini Program Office records. These include notes, minutes and abstracts of meetings, official correspondence, telegrams, memorandums, reading files, and the like.

While these three classes of material have provided our major sources, we have also drawn, when necessary, on a variety of other primary and secondary materials. Among those that deserve special mention are the press handbooks issued by several contractors,⁸ NASA press releases and fact sheets,⁹ the records of congressional hearings, and several other chronologies.¹⁰ We have also had the benefit of personal interviews and conversations with a number of persons from government and industry who participated in Project Gemini. As part of its historical program, NASA is sponsoring an oral history project based on taped interviews with participants at all levels in American space programs.¹¹ In working on Project Gemini, we have so far conducted about 150 such interviews. Although some have been useful in preparing this Chronology, their larger role lies in providing material for the narrative history. Of much greater value for strictly chronological purposes have been the less formal conversations, often by telephone, we have had with persons who have helped us to clear up specific problems.

The present text is the second revised version, after critical comments from many persons both within and outside NASA, on the Chronology as a whole and within their areas of special competence. These comments have not only been invaluable to us in correcting and improving our text; they have also on occasion emerged as significant sources in their own right.¹²

⁷ Notably Aerospace Report TOR-1001(2126-80)-3, *Gemini Program Launch Systems Final Report: Gemini/Titan Launch Vehicle; Gemini/Agna Target Vehicle; Atlas SLV-3*, January 1967; McDonnell Report F169, *Gemini Final Summary Report*, Feb. 20, 1967; North American Report SID 65-196, *Final Report of Paraglider Research and Development Program, Contract NAS 9-1484*, Feb. 19, 1965.

⁸ Lockheed, *Gemini Agna Target Press Handbook* (LMSC-A766871), Feb. 15, 1966; McDonnell External Relations Division, *Gemini Press Reference Book*, various ed.; Martin Company, *Gemini-Titan II Air Force Launch Vehicle Press Handbook*, Feb. 2, 1967. Each of these appeared in several editions, corresponding to changing vehicle configurations in different Gemini missions. The differences between the editions are minor.

⁹ Especially the MSC Fact Sheet 291 Gemini Program Series, one of which was issued for each manned Gemini mission. Author of the series was Ivan D. Ertel, MSC Assistant Historian. Another useful source was *MSC Space News Roundup*, an official biweekly publication of MSC.

¹⁰ Notably the series of annual chronologies compiled by the NASA Historical Office, with varying titles and dates of publication: Report of NASA to House Committee on Science and Astronautics, *Aeronautical and Astronautical Events of 1961*, 87th Cong., 2nd Sess., June 7, 1962; Report of NASA to House Committee on Science and Astronautics, *Astronautical and Aeronautical Events of 1962*, 88th Cong., 1st Sess., June 12, 1963; *Astronautics and Aeronautics, 1963: Chronology on Science, Technology, and Policy*, NASA SP-4004; same title, 1964, NASA SP-4005; same title, 1965, NASA SP-4006; same title, 1966, NASA SP-4007. One other chronology was of particular value: Howard T. Harris, *Gemini Launch Vehicle Chronology, 1961-1966*, AFSC Historical Publications Series 66-22-1, June 1966.

¹¹ Eugene M. Emme, Grimwood, and William D. Putnam, "Historical Notes on Oral History in NASA," NASA Hqs. Historical Note 77, November 1967.

¹² For example, memo, Chief, Technical Services Division, to Public Affairs Officer, subject: Comment Draft of "Project Gemini Operations: A Chronology," May 31, 1967; letter, B. A. Hohmann to Grimwood, Aug. 16, 1967, with enc., "Aerospace Critique, Project Gemini Technology and Operations: A Chronology"; letter, Gordon P. Cress and C. E. Heimstadt, Weber Aircraft, to MSC Historical Office, May 12, 1967.

The Chronology itself is divided into three parts, each centering on the activities during two calendar years.¹³ The real history of Project Gemini began early in 1961 with efforts to improve the Mercury spacecraft. By the end of the year, the primary objectives of a new manned space flight program had been formulated, and Project Gemini (first designated the Mercury Mark II project) was formally initiated. During 1962, the process of designing the equipment to achieve the program's objectives was the major focus. The events of these two years, and a relatively small number of relevant events during 1959 and 1960, make up Part I, "Concept and Design." Part II of the Chronology spans the years 1963 and 1964, when the main task became translating Gemini designs into working machinery reliable enough for manned space flight. This phase of the Gemini program culminated in the two unmanned Gemini missions which preceded the manned flights.¹⁴ The most visible portion of Project Gemini belongs to 1965 and 1966, dominated by the 10 manned missions which, to the public, constitute the Gemini program. Part III, "Flight Tests," chronicles the events of these two years, as well as some of the program's terminal events early in 1967. To round out this volume, we have included several appendixes, which summarize, tabulate, and otherwise make easily accessible some major aspects of Project Gemini.

The great number of persons who have contributed, in one way or another, to the preparation of this Chronology precludes our acknowledging their help individually. We can only offer our thanks for their help, without which the Gemini Chronology would have been distinctly poorer. For such shortcomings as it still suffers, its authors alone are responsible.

June 1968

JMG
BCH

¹³ We follow here the categorization suggested in NASA's *Tenth Semiannual Report to Congress, July 1-December 31, 1963*, p. 24; "The Gemini program can broadly be categorized by calendar years as follows: 1961—feasibility; 1962—design; 1963—development; 1964—production, test, initial flights; 1965 and 1966—production and operational flight missions."

¹⁴ The second unmanned flight, although attempted in 1964 and conceptually belonging to the period covered in Part II, was not accomplished until 1965; it therefore appears in Part III.

PART I
Concept and Design



PART I

Concept and Design

DeMarquis D. Wyatt, Assistant to the Director of Space Flight Development, testified in support of a National Aeronautics and Space Administration (NASA) request for \$3 million from Congress for research into space rendezvous techniques. He explained what these funds would be used for. The logistic support of a manned space laboratory, a possible post-Mercury development, would depend on the resolution of certain key problems to make rendezvous practical, among them the establishment of referencing methods for fixing the relative positions of two vehicles in space; the development of accurate, light-weight target acquisition equipment to enable the supply craft to locate the space station; the development of very accurate guidance and control systems to permit precise determination of flight paths; and the development of sources of controlled power.

1959
April
24

House Committee on Science and Astronautics and Subcommittees Nos. 1, 2, 3, and 4, Hearings on H.R. 6512, *1960 NASA Authorization* [17], 86th Cong., 1st Sess., 1959, pp. 97, 170, 267-268.

The Goett committee met for the first time. On April 1, John W. Crowley, NASA's Director of Aeronautical and Space Research, had appointed Harry J. Goett of NASA Ames Research Center, Moffett Field, California, to chair a Research Steering Committee on Manned Space Flight. Committee members agreed from the outset to concern themselves with the long-range objectives of NASA's man-in-space program, which meant deciding on the kinds of supporting research required, coordinating the research activities of the various NASA centers, and making recommendations on research and vehicles. The first order of business before the committee was a manned space flight program to follow Mercury. H. Kurt Strass of NASA's Space Task Group (STG), Langley Field, Virginia, described some preliminary STG ideas on Mercury follow-ups. These included: (1) an enlarged Mercury capsule to put two men in orbit for three days; (2) a two-man Mercury plus a large cylinder to support a two-week mission; and (3) the Mercury plus a cylinder attached by cables to a launch vehicle upper stage, the combination to be rotated to provide artificial gravity. In its 1960 budget, NASA had requested \$2 million to study possible methods of constructing a manned orbiting laboratory or converting the Mercury capsule into a two-man laboratory for extended space flights.

May
25-26

PROJECT GEMINI: A CHRONOLOGY

- 1959
May
- Memo, NASA to Langley and Lewis Research Centers, Subj: Research Steering Committee on Manned Space Flight, Apr. 1, 1959; Minutes of Meetings of Research Steering Committee on Manned Space Flight, May 25-26, 1959, pp. 1, 2, 6, 7, 9; House Subcommittee of the Committee on Appropriations, Hearings, *National Aeronautics and Space Administration Appropriations*, 86th Cong., 1st Sess., 1959, pp. 42-45.
- June*
4
- At a staff meeting, Space Task Group Director Robert R. Gilruth suggested studying a Mercury follow-on program using maneuverable Mercury capsules for land landings in predetermined areas.
- Memo, Paul E. Purser to Gilruth, Subj: Log for the Week of June 1, 1959.
- 22
- H. Kurt Strass of Space Task Group's Flight Systems Division (FSD) recommended the establishment of a committee to consider the preliminary design of a two-man space laboratory. Representatives from each of the specialist groups within FSD would work with a special projects group, the work to culminate in a set of design specifications for the two-man Mercury.
- Memo, Strass to Chief, FSD, Subj: Activation of a Study Group Pertaining to Advanced Manned Space Projects, June 22, 1959.
- August*
12
- The New Projects Panel of Space Task Group (STG) met for the first time, with H. Kurt Strass in the chair. The panel was to consider problems related to atmospheric reentry at speeds approaching escape velocity, maneuvers in the atmosphere and space, and parachute recovery for earth landing. Alan B. Kehlet of STG's Flight Systems Division was assigned to initiate a program leading to a second-generation capsule incorporating several advances over the Mercury spacecraft: It would carry three men; it would be able to maneuver in space and in the atmosphere; the primary reentry system would be designed for water landing, but land landing would be a secondary goal. At the next meeting, on August 18, Kehlet offered some suggestions for the new spacecraft. The ensuing discussion led panel members to agree that a specifications list should be prepared as the first step in developing an engineering design requirement.
- Memos, Strass to Chief, FSD, Subj: First Meeting of New Projects Panel . . . , Aug. 15, 1959; Second Meeting of the New Projects Panel . . . , Aug. 26, 1959.
- September*
1
- McDonnell Aircraft Corporation, St. Louis, Missouri, issued a report on the company's studies using a modified Mercury capsule to explore some problems of space flight beyond the initial manned exploration of space through Mercury. The 300-page report discussed six follow-on experiments: touchdown control, maneuver in orbit, self-contained guidance, 14-day mission, manned reconnaissance, and lunar-orbit reentry. These were more in the nature of technically supported suggestions than firm proposals, but all six experiments could be conducted with practical modifications of Mercury capsules.
- McDonnell Engineering Report No. 6919, "Follow On Experiments, Project Mercury Capsules, 1 September 1959," revised Oct. 5, 1959.
- 28
- Space Task Group's (STG) New Projects Panel discussed the McDonnell Aircraft Corporation proposals for follow-on experiments using Project

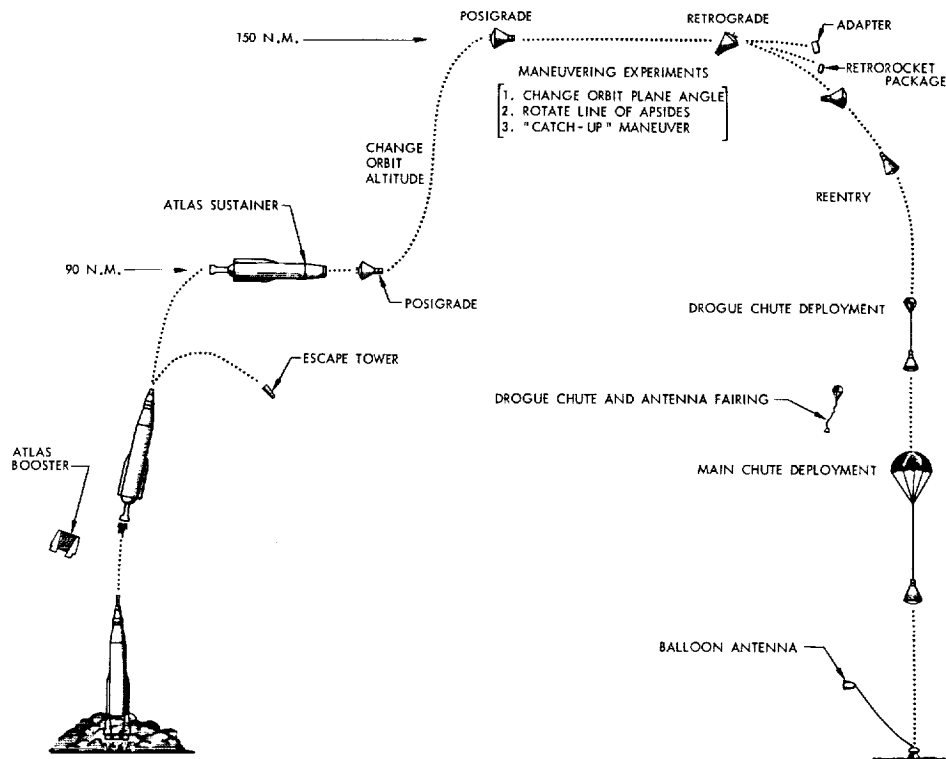

Figure 1.—McDonnell's proposed mission for a Mercury capsule modified to be capable of maneuvering in orbit. This was one of the six follow-on series of experiments incorporated in the company's report on potential uses of the Mercury capsule beyond the officially approved program. (McDonnell Engineering Report No. 6919, "Follow on Experiments, Project Mercury Capsule, 1 September 1959," rev. Oct. 5, 1959, p. 2.3-2.)

Mercury capsules. After concluding that these proposals came under panel jurisdiction, Chairman H. Kurt Strass asked for further studies to provide STG with suggestions for action. Discussion at the panel's next meeting on October 5 centered on McDonnell's proposals. All had shortcomings, but the panel felt that certain potentially valuable elements might be combined into a single proposal promising increased spacecraft performance and an opportunity to evaluate some advanced mission concepts at an early date. Noting that any amplification of current Mercury missions would demand increased orbital weight, the panel advised an immediate study of possible follow-on missions to determine the performance specifications for a second-stage propulsion system with restart and thrust control capability. Other studies were needed to specify a second-stage guidance and control system to ensure the achievement of the desired orbital altitude (up to 150 miles) and to control reentry within the heat protection limits of the current, or slightly modified, capsule. Also worth studying, in the panel's opinion, were maneuvering in orbit (rendezvous experiments) and within the atmosphere (reentry control experiments).

Memos, Strass to Chief, FSD, Subj: Third Meeting of New Projects Panel . . . (Information), Oct. 1, 1959; Fourth Meeting of the New Projects Panel . . . (action requested), Oct. 7, 1959.

1959
September

PROJECT GEMINI: A CHRONOLOGY

1960
January
7

Representatives of Engineering and Contracts Division and Flight Systems Division (FSD) met to discuss future wind tunnel test needs for advanced Mercury projects. After Alan B. Kehlet remarked on available test facilities, Caldwell C. Johnson and H. Kurt Strass presented their ideas on advanced configurations. Johnson had been working on modifications to the existing Mercury configuration, chiefly in the areas of afterbody, landing system (rotors to control impact point), and retro-escape system, rather than on advanced configuration concepts. Strass suggested that advanced work be classed as either (1) modifications refining the design of the present Mercury or (2) new concepts in configuration design, and others present agreed. Johnson consented to design models for both program categories. FSD's Aerodynamics Section would arrange for and perform tests necessary to evaluate both modifications and advanced proposals. Strass also suggested another modification, a larger heatshield diameter allowing for half-ringed flaps which could be extended from the portion of the afterbody near the heatshield to provide some subsonic lifting capabilities. Strass stated the need for aerodynamic information on an advanced Mercury configuration under consideration by his group, and on the lenticular vehicle proposed by Aerodynamics Section.

Memo, Dennis F. Hasson to Chief, FSD, Subj: Meeting of January 7, 1960, to Discuss Future Wind-Tunnel Test Needs for Advanced Mercury Projects, Jan. 11, 1960.

April
5

Preliminary specifications were issued by Space Task Group (STG) to modify the Mercury capsule by adding a reentry control navigation system. The modified capsule would obtain a small lifting capability (lift-over-drag ratio would equal approximately 0.26). The self-contained capsule navigation system would consist of a stable platform, a digital computer, a possible star tracker, and the necessary associated electronic equipment. Dispersion from the predicted impact point would be less than 10 miles. The prospective development called for a prototype to be delivered to NASA for testing in February 1961; the first qualified system, or Modification I, to be delivered by August 1961; and the final qualified system, or Modification II, to be delivered by January 1962. STG anticipated that four navigational systems (not including prototype or qualification units) would be required.

NASA-STG, Subj: Preliminary Specification for Reentry Control Navigation System, Apr. 5, 1960.

May
16-17

Representatives of NASA's research centers gathered at Langley Research Center to present papers on current programs related to space rendezvous and to discuss possible future work on rendezvous. During the first day of the conference, papers were read on the work in progress at Langley, Ames, Lewis, and Flight Research Centers, Marshall Space Flight Center, and Jet Propulsion Laboratory. The second day was given to a roundtable discussion. All felt strongly that rendezvous would soon be essential, that the technique should be developed immediately, and that NASA should make rendezvous experiments to develop the technique and establish the feasibility of rendezvous.

John M. Eggleston, "Inter-NASA Research and Space Development Centers Discussion on Space Rendezvous, Langley Research Center, May 16-17, 1960," May 25, 1960.

Space Task Group (STG) issued a set of guidelines for advanced manned space flight programs. The document comprised five papers presented by STG personnel at a series of meetings with personnel from NASA Headquarters and various NASA field installations during April and May. Primary focus was a manned circumlunar mission, or lunar reconnaissance, but in his summary, Charles J. Donlan, Associate Director (Development), described an intermediate program that might fit into the period between the phasing out of Mercury and the beginning of flight tests of the multimanned vehicle. During this time, "it is attractive to consider the possibility of a flight-test program involving the reentry unit of the multimanned vehicle which at times we have thought of as a lifting Mercury." What form such a vehicle might take was uncertain, but it would clearly be a major undertaking; much more information was needed before a decision could be made. To investigate some of the problems of a reentry vehicle with a lift-over-drag ratio other than zero, STG had proposed wind tunnel studies of static and dynamic stability, pressure, and heat transfer at Langley, Arnold Engineering Development Center, and Ames facilities.

STG, "Guidelines for Advanced Manned Space Vehicle Program," June 1960, pp. ii, 49-50, 52, 53.

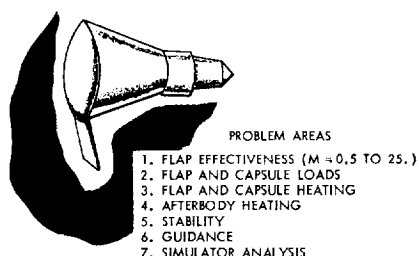

Figure 2.—One version of the "lifting" Mercury capsule being considered in 1960 for a flight-test program between the end of Mercury and the start of a manned circumlunar program. (STG, "Guidelines for Advanced Manned Space Vehicle Program," June 1960, p. 53)

McDonnell Aircraft Corporation proposed a one-man space station comprising a Mercury capsule plus a cylindrical space laboratory capable of supporting one astronaut in a shirtsleeve environment for 14 days in orbit. Gross weight of the combined vehicle at launch would be 7259 pounds (Mercury, as of October 25, 1960, was 4011 pounds), which would provide an 1100-pound, laboratory-test payload in a 150-nautical-mile orbit, boosted by an Atlas-Agena B. The result would be a "minimum cost manned space station."

McDonnell, "One Man Space Station," Aug. 24, 1960 (rev. Oct. 28, 1960).

NASA's Space Exploration Program Council met in Washington to discuss manned lunar landing. Among the results of the meeting was an agreement that NASA should plan an earth-orbital rendezvous program independent of, although contributing to, the manned lunar program.

Minutes, Space Exploration Program Council Meeting, Jan. 5-6, 1961.

Space Task Group management held a Capsule Review Board meeting. The first topic on the agenda was a follow-on Mercury program. Several types of missions were considered, including long-duration, rendezvous, artificial grav-

1960
June
During
the
month

August
24

1961
January
5-6

20

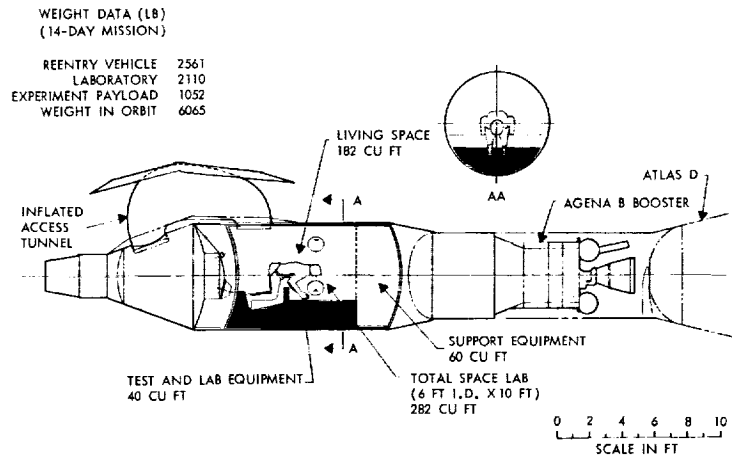

Figure 3.—One of two versions of a one-man space station proposed by McDonnell. In this version, access to the laboratory was through an inflated tunnel connecting the Mercury-type capsule (in which the astronaut rode into orbit) with the laboratory proper (the forward section of an Agena booster attached to the capsule). (McDonnell, "One Man Space Station," Aug. 24, 1960, rev. Oct. 28, 1960, p. 3.)

1961
January

ity, and flight tests of advanced equipment. Major conclusion was that a follow-on program needed to be specified in greater detail.

STG, "Notes on Capsule Review Board Meeting," with enclosed chart, "Follow-on Mercury Missions," Jan. 20, 1961.

February
13

NASA and McDonnell began discussions of an advanced Mercury spacecraft. McDonnell had been studying the concept of a maneuverable Mercury spacecraft since 1959. On February 1, Space Task Group (STG) Director Robert R. Gilruth assigned James A. Chamberlin, Chief, STG Engineering Division, who had been working with McDonnell on Mercury for more than a year, to institute studies with McDonnell on improving Mercury for future manned space flight programs. Work on several versions of the spacecraft, ranging from minor modification to radical redesign, got under way immediately. Early in March, the prospect of conducting extravehicular operations prompted Maxime A. Faget of STG to query John F. Yardley of McDonnell about the possibility of a two-man version of the improved Mercury. Yardley raised the question with Walter F. Burke, a McDonnell vice president, who in turn ordered that a design drawing of a two-man Mercury be prepared. STG described the work in progress at McDonnell to Abe Silverstein of NASA Headquarters in a meeting at Wallops Island, Virginia, March 17–20. On April 1, James T. Rose of STG joined Chamberlin in studying possible objectives for the advanced Mercury; he concentrated on mission planning, trajectory analysis, and performance.

Memo, Purser to Gilruth, Subj: Log for the Week of Jan. 30, 1961, Feb. 6, 1961; paper, McDonnell, anon., "Early History of Project Gemini," undated; Action Items, Management Discussion, Mar. 17–20, 1961; interviews: Purser, Houston, Mar. 17, 1964; Chamberlin, Houston, Feb. 15, 1965, and Mar. 10, 1966; Rose, St. Louis, Apr. 13, 1966; Burke, St. Louis, Apr. 15, 1966; Yardley, St. Louis, Apr. 13, 1966; conversation with Faget, Houston, March 1966.

NASA issued study contract NAS 9-119 to McDonnell for improvement of the Mercury spacecraft. McDonnell formed a small project group for the study, which immediately began looking to Mercury spacecraft component improvement, with accessibility as the guideline. Mercury had been a first step, almost an experiment, while the improved Mercury was to be an operational vehicle. One result of this line of thought was a basic change in equipment location, from inside the pressure vessel (where it had been in Mercury) to the outside. The contractor was authorized to acquire several long-lead-time procurement items under an amendment to the basic Mercury contract, but Space Task Group limited company expenditures to \$2.5 million. The McDonnell project team initially included 30 to 40 engineers.

1961
April
14

"Early History of Project Gemini"; interviews: Fred J. Sanders, St. Louis, Apr. 14, 1966; Winston D. Noid, St. Louis, Apr. 14, 1966; Glenn F. Bailey, Houston, Dec. 13, 1966.

Major General Don R. Ostrander, NASA Director of Launch Vehicle Programs, described plans for work on orbital rendezvous techniques to the House Committee on Science and Astronautics. The subject of orbital rendezvous figured prominently in House hearings on NASA's proposed 1962 budget. On May 23, the Committee met to hear Harold Brown, Director of Defense Research and Engineering, and Milton W. Rosen, Ostrander's Deputy, explain the needs for orbital rendezvous, the means of achieving it, and the support level of component activities required to achieve it.

24

House Committee on Science and Astronautics and Subcommittees Nos. 1, 3, and 4, Hearings on H.R. 3238 and H.R. 6029 (superseded by H.R. 6874), *1962 NASA Authorization* [No. 7], Part 2, 87th Cong., 1st Sess., 1961, pp. 805-806; House Committee on Science and Astronautics, Hearing, *Orbital Rendezvous in Space* [No. 13], 87th Cong., 1st Sess., May 23, 1961.

Anticipating the expanded scope of manned space flight programs, Space Task Group (STG) proposed a manned spacecraft development center. The nucleus for a center existed in STG, which was handling the Mercury program. A program of much larger magnitude would require a substantial expansion of staff and facilities and of organization and management controls.

May
1

STG, "Manned Spacecraft Development Center, Organizational Concepts and Staffing Requirements," May 1, 1961.

A NASA Headquarters working group, headed by Bernard Maggin, completed a staff paper presenting arguments for establishing an integrated research, development, and applied orbital operations program at an approximate cost of \$1 billion through 1970. The group identified three broad categories of orbital operations: inspection, ferry, and orbital launch. It concluded that future space programs would require an orbital operations capability and that the development of an integrated program, coordinated with Department of Defense, should begin immediately. The group recommended that such a program, because of its scope and cost, be independent of other space programs and that a project office be established to initiate and implement the program.

5

NASA Hqs., staff paper, "Guidelines for a Program for Manned and Unmanned Orbital Operations," May 1961; briefing memo, Maggin to Assoc. Adm., Subj: Staff Paper—"Guidelines for a Program for Manned and Unmanned Orbital Operations," May 22, 1961.

INTERCEPTION & INSPECTION



- INTERCEPT
- INSPECT

FERRY

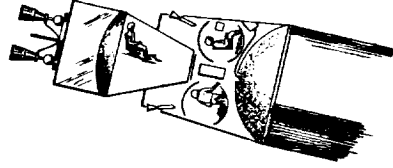

- SUPPLY & MAINTENANCE
- ASSEMBLY
- PERSONNEL & EQUIPMENT TRANSFER
- RESCUE & RECOVERY

ORBITAL LAUNCH

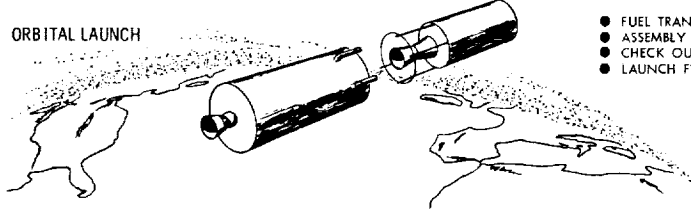

- FUEL TRANSFER
- ASSEMBLY
- CHECK OUT
- LAUNCH FROM ORBIT

Figure 4.—The classes of orbital operations which a NASA Headquarters working group felt would be required in any future space program and which thus made a rendezvous development program necessary. (NASA Hq., staff paper, "Guidelines for a Program for Manned and Unmanned Orbital Operations," May 1961, p. 4)

1961
May
8

Martin Company personnel briefed NASA officials in Washington, D.C., on the Titan II weapon system. Albert C. Hall of Martin had contacted NASA's Associate Administrator, Robert C. Seamans, Jr., on April 7 to propose the Titan II as a launch vehicle for a lunar landing program. Although skeptical, Seamans nevertheless arranged for a more formal presentation. Abe Silverstein, NASA Director, Office of Space Flight Programs, was sufficiently impressed by the Martin briefing to ask Director Robert R. Gilruth and Space Task Group to study possible Titan II uses. Silverstein shortly informed Seamans of the possibility of using the Titan II to launch a scaled-up Mercury spacecraft.

Interview, Seamans, Washington, May 26, 1966.

17

Space Task Group (STG) issued a Statement of Work for a Design Study of a Manned Spacecraft Paraglide Landing System. The purpose of the study was to define and evaluate problem areas and to establish the design parameters of a system to provide spacecraft maneuverability and controlled energy descent and landing by aerodynamic lift. McDonnell was already at work on a modified Mercury spacecraft; the proposed paraglide study was to be carried on concurrently to allow the paraglide landing system to be incorporated as an integral subsystem. STG Director Robert R. Gilruth requested that contracts for the design study be negotiated with three companies which already had experience with the paraglide concept: Goodyear Aircraft Corporation, Akron, Ohio; North American Aviation, Inc., Space and Information Systems Division, Downey, California; and Ryan Aeronautical Company, San Diego, California. Each contract would be funded to a maximum of \$100,000 for a study to be completed within two and one-half months from the date the contract was awarded. Gilruth expected one of these companies subsequently to be selected to develop and manufacture a paraglide system based on the approved design.

concept. In less than three weeks, contracts had been awarded to all three companies. Before the end of June, the design study formally became Phase I of the Paraglider Development Program.

1961
May

Memos, Gilruth to STG Procurement Officer, Subj: Design Study of a Paraglide Landing System for a Manned Spacecraft, with enc., May 17 and 22, 1961; "Statement of Work for a Design Study of a Manned Spacecraft Paraglide Landing System," May 17, 1961; "Paraglider Development Program, Phase I—Design Study: Test Programs," June 30, 1961.

James A. Chamberlin, Chief, Engineering Division, Space Task Group (STG), briefed Director Robert R. Gilruth, senior STG staff members, and George M. Low and John H. Disher of NASA Headquarters on McDonnell's advanced

June
9

Figure 5.—The deployment of the Mercury paraglider proposed by North American after Phase I of the Paraglider Development Program. (North American Aviation, Inc., Space and Information Systems Division, "Paraglider Development Program, Phase I: Final Report," SID 61-226, Aug. 15, 1961, p. 18.)

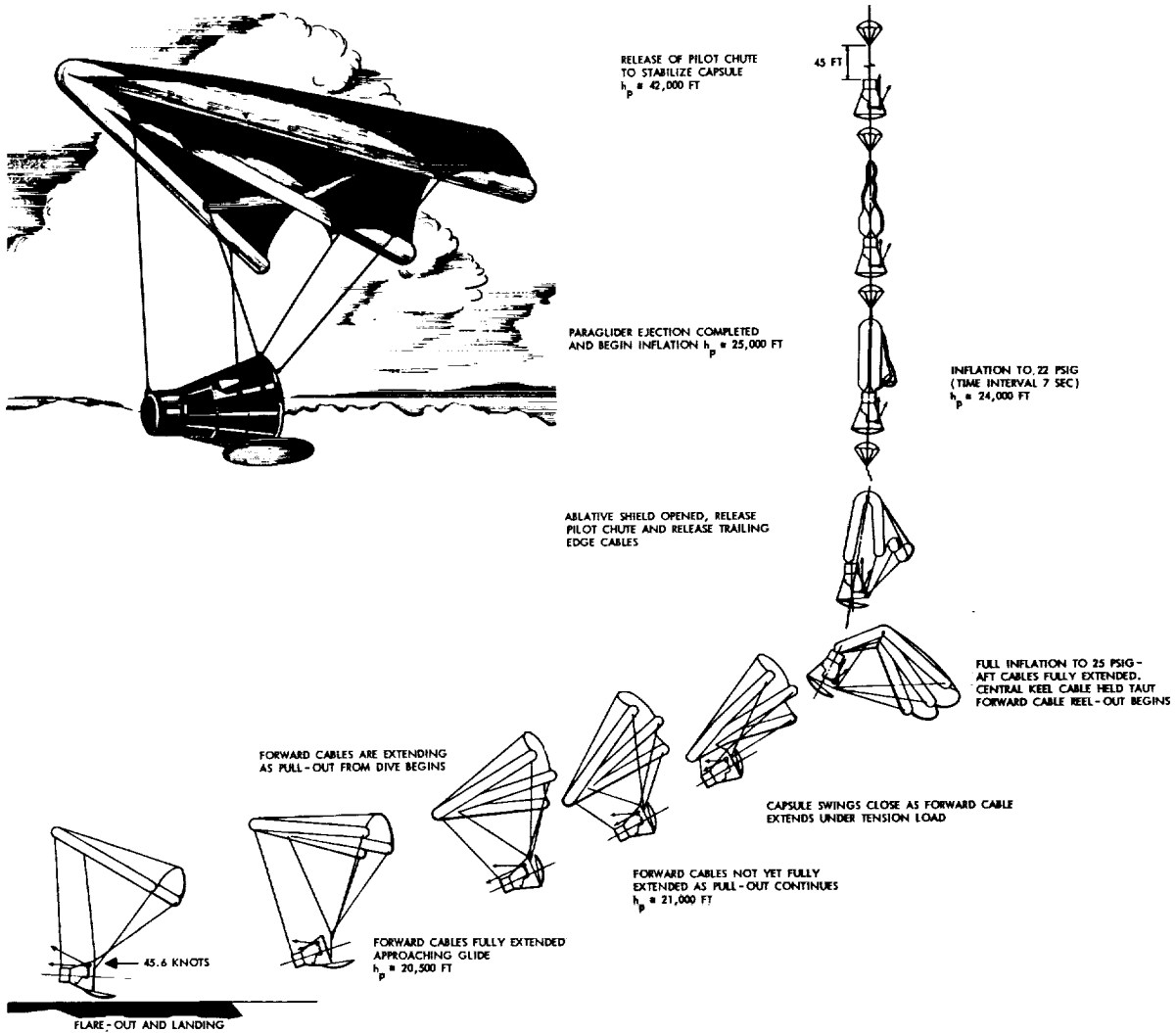

1961
June

capsule design. The design was based on increased component and systems accessibility, reduced manufacturing and checkout time, easier pilot insertion and emergency egress procedures, greater reliability, and adaptability to a paraglide landing system. It departed significantly from Mercury capsule design in placing most components outside the pressure vessel and increasing retrograde and posigrade rocket performance. The group was reluctant to adopt what seemed to be a complete redesign of the Mercury spacecraft, but it decided to meet again on June 12 to review the most desirable features of the new design. After discussing most of these items at the second meeting, the group decided to ask McDonnell to study a minimum-modification capsule to provide an 18-orbit capability.

STG, "Notes on Capsule Review Board Meeting, McDonnell Advanced Capsule Design," June 9, 12, 1961.

12

Space Task Group and McDonnell representatives discussed paraglider engineering and operations problems at a meeting in St. Louis. Immediate concerns were how to prevent the spacecraft from "nosing in" during the landing phase, a requirement for increased stowage areas in the spacecraft, and a method to effect emergency escape for the pilot after deployment of the paraglider wing.

Minutes of Meeting, Subj: Paraglider Development Program, June 21, 1961.

July
7

Walter F. Burke of McDonnell summarized the company's studies of the re-designed Mercury spacecraft for Space Task Group's senior staff. McDonnell had considered three configurations: (1) the minimum-change capsule, modified only to improve accessibility and handling, with an adapter added to carry such

Figure 6.—McDonnell-proposed two-man Mercury spacecraft. Shown is the interior arrangement of spacecraft equipment. (McDonnell Report, "Manned Spacecraft—Advanced Versions," July 27-28, 1961, part 4, "Two Man MK II Spacecraft," unpagged report.)

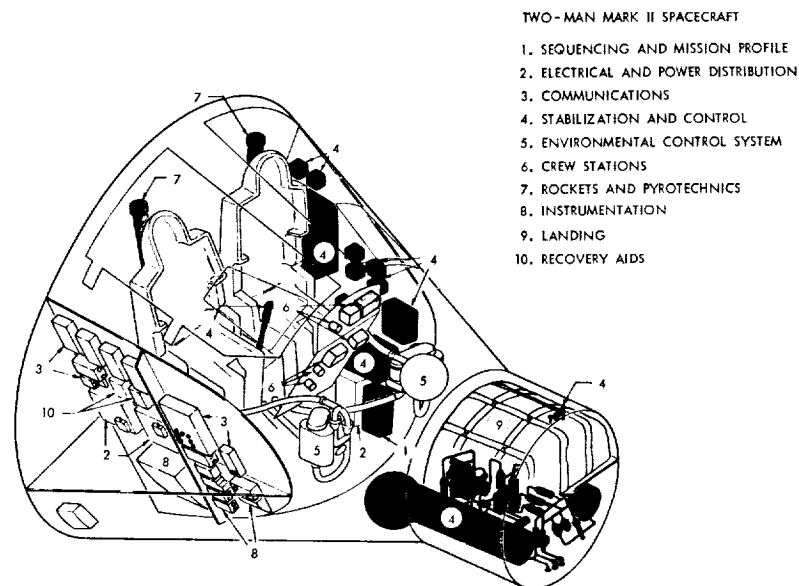

items as extra batteries; (2) a reconfigured capsule with an ejection seat installed and most of the equipment exterior to the pressure vessel on highly accessible pallets; and (3) a two-man capsule, similar to the reconfigured capsule except for the modification required for two- rather than one-man operation. The capsule would be brought down on two Mercury-type main parachutes, the ejection seat serving as a redundant system. In evaluating the trajectory of the two-man capsule, McDonnell used Atlas Centaur booster performance data.

1961
July

STG, "Notes on Senior Staff Meeting, Presentation by McDonnell Aircraft Corporation on the Results of Mercury Capsule Hardware Studies Applicable to an Advanced Mercury Program," July 11, 1961.

Representatives of NASA and McDonnell met to decide what course McDonnell's work on the advanced Mercury should take. The result: McDonnell was to concentrate all its efforts on two versions of the advanced spacecraft. The first required minimum changes; it was to be capable of sustaining one man in space for 18 orbits. The second, a two-man version capable of advanced missions, would require more radical modifications.

27-28

"Early History of Project Gemini"; McDonnell Report, "Manned Spacecraft—Advanced Versions," July 27-28, 1961.

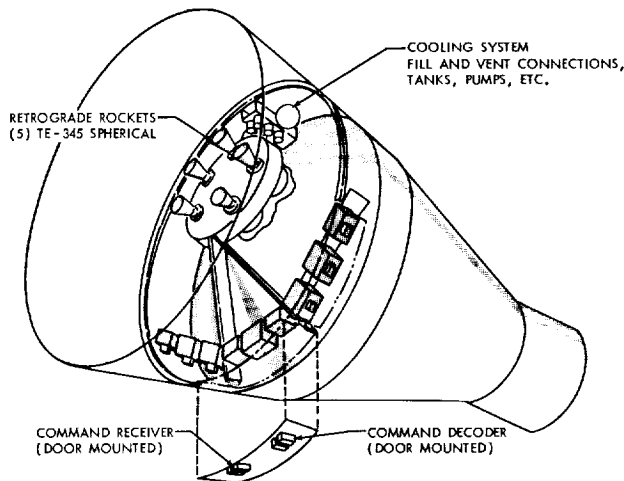

Figure 7.—The adapter section of McDonnell's proposed two-man Mercury spacecraft. (McDonnell Report, "Manned Spacecraft—Advanced Versions," July 27-28, 1961, part 4, "Two Man MK II Spacecraft," unpagged.)

Space Task Group engineers James A. Chamberlin and James T. Rose proposed adapting the improved Mercury spacecraft to a 35,000-pound payload, including a 5000-pound "lunar lander." This payload would be launched by a Saturn C-3 in the lunar-orbit-rendezvous mode. The proposal was in direct competition with the Apollo proposals that favored direct landing on the Moon with a 150,000-pound payload launched by a Nova-class vehicle of approximately 12 million pounds of thrust.

During
the
month

Interviews: Rose; Chamberlin, Houston, June 9, 1966.

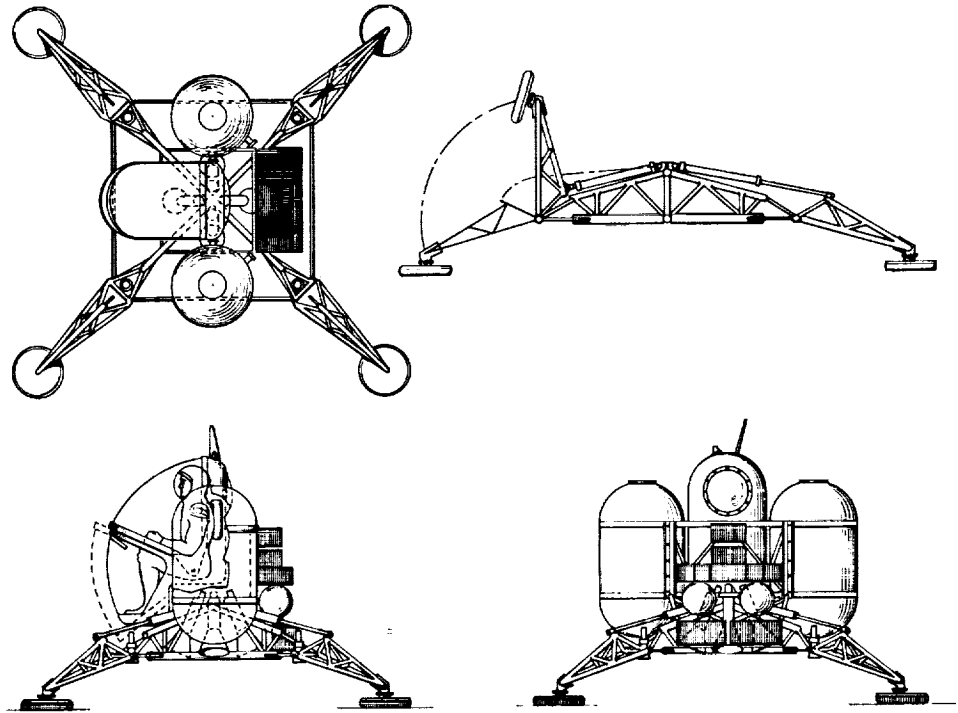

Figure 8.—Engineering drawing by Harry C. Shoaf (Space Task Group Engineering Division) of the proposed "lunar lander" to be used with an advanced version of the Mercury spacecraft. (Shoaf, Drawing, Nov. 15, 1961.)

1961
July
During
the
month

James L. Decker of Martin Company submitted a proposal for a Titan-boosted Mercury vehicle. A Mercury-Titan program, expected to span an 18-month flight schedule, would benefit from the Air Force's booster development and test of the ballistic missile system and the considerable design and test that the Air Force had expended in the Dyna-Soar program to adapt the vehicle to manned space flight. The Titan, with its sea-level rating of 430,000 pounds of thrust in the first stage and 100,000 pounds in the second stage, was capable of lifting significantly heavier spacecraft payloads than the Mercury-Atlas. Its hypergolic propulsion system, using storable liquid propellants, was a much simpler system than the cryogenic propellant system in Atlas. A highly reliable booster could be provided, employing complete redundancy in the flight control systems in the form of a three-axis reference system, autopilot, servo, electrical, and hydraulic systems. The short time he proposed would depend on the availability of pad 19 at Cape Canaveral, planned for conversion to the Titan II configuration. Pad 19, unlike the other three Titan I pads, had been intended for space applications and was better designed for required prelaunch test programs.

Decker, Martin-Baltimore, "A Program Plan for a Titan Boosted Mercury Vehicle," July 1961.

August
3

Representatives of Martin Company briefed Director Robert R. Gilruth and some of the senior staff of Space Task Group on Titan II technical characteristics and expected performance. At a senior staff meeting four days later,

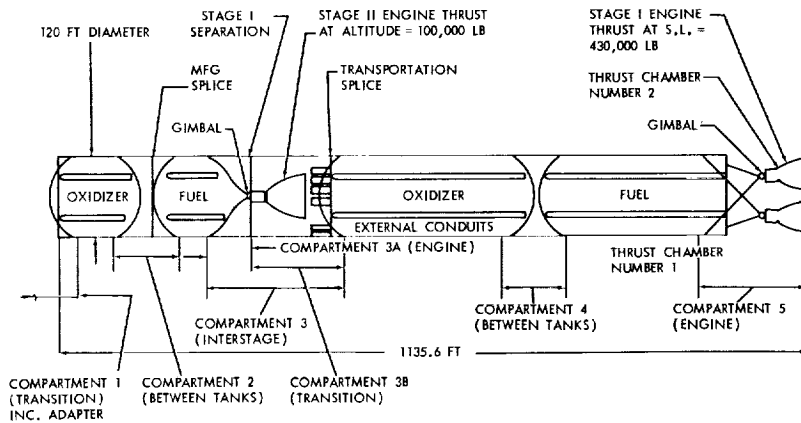

Figure 9.—The modified Titan II booster that was to launch the advanced Mercury spacecraft. (STG, "Preliminary Project Development Plan for an Advanced Manned Space Program Utilizing the Mark II Two Man Spacecraft," Aug. 14, 1961, Fig. 4.1.)

August 7, Gilruth commented on the Titan II's promise for manned space flight, particularly its potential ability to place larger payloads in orbit than could Atlas, which would make it "a desirable booster for a two-man spacecraft." Martin had estimated the cost of procuring and launching nine Titan II boosters, with cost of ancillary equipment, at \$47.889 million spread over fiscal years 1962 through 1964.

1961
August

STG, "Notes on Senior Staff Meeting," Aug. 8, 1961, p. 3; Purser, notes on briefing by Decker and Bastian Hello of Martin to Gilruth *et al.* on Titan II technical and performance aspects, Aug. 3, 1961; Chart, Mercury-Titan Program, Program Cost, Aug. 2, 1961.

Fred J. Sanders and three other McDonnell engineers arrived at Langley Research Center to help James A. Chamberlin and other Space Task Group (STG) engineers who had prepared a report on the improved Mercury concept, now known as Mercury Mark II. Then, with the assistance of Warren J. North of NASA Headquarters Office of Space Flight Programs, the STG group prepared a preliminary Project Development Plan to be submitted to NASA Headquarters. Although revised six times before the final version was submitted on October 27, the basic concepts of the first plan remained unchanged in formulating the program.

14

Interviews: Sanders; Chamberlin, June 9, 1966; William C. Muhly, Houston, June 2, 1967; STG, "Preliminary Project Development Plan for an Advanced Manned Space Program Utilizing the Mark II Two Man Spacecraft," Aug. 14, 1961.

James A. Chamberlin, Chief of Space Task Group (STG) Engineering Division, expecting approval of the Mark II spacecraft program within 30 days, urged STG Director Robert R. Gilruth to begin reorienting McDonnell, the proposed manufacturer, to the new program. To react quickly once the program was approved, McDonnell had to have an organization set up, personnel assigned, and adequate staffing ensured. Chamberlin suggested an amendment to the existing letter contract under which McDonnell had been authorized to

October
27

1961
October

procure items for Mercury Mark II. This amendment would direct McDonnell to devote efforts during the next 30 days to organizing and preparing to implement its Mark II role.

Memo, Chamberlin to Director, Subj: Proposed Amendment to Letter Contract No. 6 to Contract NAS 5-59, with enc., Oct. 27, 1961.

27

Space Task Group (STG), assisted by George M. Low, NASA Assistant Director for Space Flight Operations, and Warren J. North of Low's office, prepared a project summary presenting a program of manned space flight for 1963-1965. This was the final version of the Project Development Plan, work on which had been initiated August 14. A two-man version of the Mercury spacecraft would be lifted by a modified Titan II booster. The Atlas-Agena B combination would be used to place the Agena B into orbit as the target vehicle for rendezvous. The proposed plan was based on extensive use of Mercury technology and components for the spacecraft. A suggestion was incorporated to negotiate a sole-source, cost-plus-fixed-fee contract with McDonnell Aircraft Corporation for the Mark II Mercury spacecraft. Launch vehicle procurement would be arranged through the Air Force: with General Dynamics/Astronautics, San Diego, California, for Atlas launch vehicles; with Martin-Marietta Space Systems Division (Martin-Baltimore), Baltimore, Maryland, for the modified Titan II launch vehicles; and with Lockheed Missiles and Space Company, Sunnyvale, California, for the Agena target vehicles. A project office would be established to plan, direct, and supervise the program. Manpower requirements for this office were expected to reach 177 by the end of fiscal year 1962. Estimated cost of the proposed program was about \$530 million. STG justified this plan by suggesting that the next step in manned space exploration after Mercury would be to gain experience in long-duration and rendezvous missions. The Mark II program was to provide an immediate continuation of a successful Project Mercury, using equipment and vehicles already developed for other programs as much as possible. The Mark II would allow a much wider range of mission objectives than Mercury, which could not readily be adapted to other than simple orbital missions of up to one day's duration. Mark II objectives encompassed flights of longer duration than the 18 orbits to which Mercury was limited, making a multiman crew necessary, contributing to the development of operational techniques and equipment for extended space flights, and providing data on the psychological and physiological effects on the crew of lengthy periods in the space environment. Objectives also included flights to develop techniques for achieving rendezvous in orbit—a necessary prelude to advanced flights in order to extend the limits on mission capabilities imposed by the limitations of available boosters—and controlled land landing to avoid or minimize the magnitude of the effort required to recover spacecraft at sea and to put space flight on something like a routine basis. The Mark II project would be quickly accomplished; not only would most hardware be modifications of what already existed, but equipment would be modularized, allowing mission requirements and available hardware to be maintained in balance with minimum dislocations. Twelve flights were planned, beginning with an unmanned qualification flight in May 1963. Succeeding flights would occur at two-month intervals, ending in March 1965. Flight No. 2 would be a manned 18-orbit mission with the twin objectives of testing crew performance in missions of that length

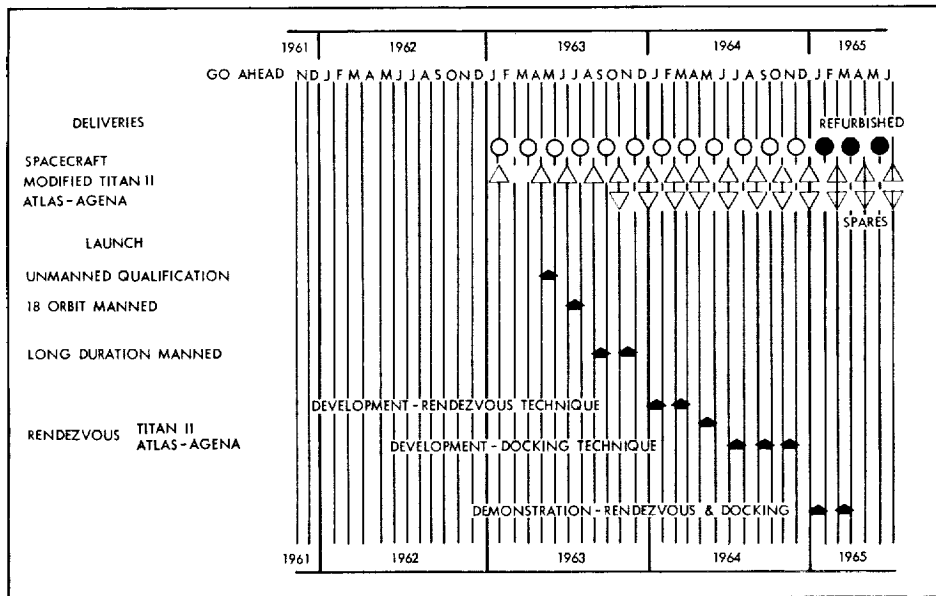

Figure 10.—The launch schedule that accompanied the final version of the Mark II Project Development Plan. (STG, "Project Development Plan for Rendezvous Development Utilizing the Mark II Two Man Spacecraft," Oct. 27, 1961, Fig. 5.5)

and of further qualifying the spacecraft for longer missions. The next two flights (Nos. 3 and 4) would be long-duration tests to demonstrate the crews' ability to function in space for up to 14 days. Remaining flights were to establish orbital rendezvous techniques and to demonstrate the capability to rendezvous and dock in space.

1961
October

STG, "Project Development Plan for Rendezvous Development Utilizing the Mark II Two-Man Spacecraft," Oct. 27, 1961; interview, James E. Bost, Houston, June 1, 1967.

Martin Company received informal indications from the Air Force that Titan II would be selected as the launch vehicle for NASA's advanced Mercury. Martin, Air Force, and NASA studied the feasibility of modifying complex 19 at Cape Canaveral from the Titan weapon system configuration to the Mercury Mark II launch vehicle configuration.

During
the
month

Interviews: Walter D. Smith and Hello, Baltimore, May 23, 1966.

Space Task Group's Engineering Division Chief James A. Chamberlin and Director Robert R. Gilruth briefed NASA Associate Administrator Robert C. Seamans, Jr., at NASA Headquarters on the Mercury Mark II proposal. Specific approval was not granted, but Chamberlin and Gilruth left Washington convinced that program approval would be forthcoming.

November
1

Interview, Chamberlin, June 9, 1966.

Space Task Group, the organization charged with directing Project Mercury and other manned space flight programs, was redesignated Manned Spacecraft Center, with Robert R. Gilruth as Director.

1

Memo, Purser to MSC Employees, Subj: Designation of Space Task Group as "Manned Spacecraft Center," Nov. 1, 1961.

1961
November
15

McDonnell submitted to Manned Spacecraft Center the detail specification of the Mercury Mark II spacecraft. A number of features closely resembled those of the Mercury spacecraft. Among these were the aerodynamic shape, tractor rocket escape tower, heatsnield, impact bag to attenuate landing shock, and the spacecraft-launch vehicle adapter. Salient differences from the Mercury concept included housing many of the mission-sustaining components in an adapter that would be carried into orbit rather than being jettisoned following launch, bipropellant thrusters to effect orbital maneuvers, crew ejection seats for emergency use, onboard navigation system (inertial platform, computers, radar, etc.), and fuel cells as electrical power source in addition to silver-zinc batteries. The long-duration mission was viewed as being seven days.

McDonnell Report No. 8356, "Mercury Mk II Spacecraft Detail Specification,"
Nov. 15, 1961.

20

Manned Spacecraft Center notified North American to proceed with Phase II-A of the Paraglider Development Program. A letter contract, NAS 9-167, followed on November 21; contract negotiations were completed February 9, 1962; and the final contract was awarded on April 16, 1962. Phase I, the design studies that ran from the beginning of June to mid-August 1961, had already demonstrated the feasibility of the paraglider concept. Phase II-A, System Research and Development, called for an eight-month effort to develop the design concept of a paraglider landing system and to determine its optimal performance configuration. This development would lay the groundwork for Phase II, Part B, comprising prototype fabrication, unmanned and manned flight testing, and the completion of the final system design. Ultimately Phase III—Implementation—would see the paraglider being manufactured and pilots trained to fly it.

Message, Bailey to Neil C. Dopheide, Nov. 20, 1961; STG, "Statement of Work for Phase II, Part A, System Research and Development of a Paraglider Development Program," Sept. 15, 1961; NAA, letter 63MA8041, Subj: Final Settlement Proposal, Paraglider, Phase II, Part A, NAS 9-167, June 11, 1963, p. I-1.

20

Milton W. Rosen, Director of Launch Vehicles and Propulsion in NASA's Office of Manned Space Flight, presented recommendations on rendezvous to D. Brainerd Holmes, Director of Manned Space Flight. The working group Rosen chaired had completed a two-week study of launch vehicles for manned space flight, examining most intensively the technical and operational problems posed by orbital rendezvous. Because the capability for rendezvous in space was essential to a variety of future missions, the group agreed that "a vigorous high priority rendezvous development effort must be undertaken immediately." Its first recommendation was that a program be instituted to develop rendezvous capability on an urgent basis.

Memos: Rosen to Holmes, Subj: Large Launch Vehicle Program, Nov. 6, 1961; Rosen to Holmes, Subj: Recommendations for NASA Manned Space Flight Vehicle Program, Nov. 20, 1961, with enc., "Report of Combined Working Group on Vehicles for Manned Space Flight"; Seamans to Holmes, Subj: Recommendations for NASA Manned Space Flight Vehicle Program, Dec. 4, 1961.

28-29

Representatives of the Space and Information Systems Division of North American, Langley Research Center, Flight Research Center (formerly High

Speed Flight Station), and Manned Spacecraft Center met to discuss implementing Phase II-A of the Paraglider Development Program. They agreed that paraglider research and development would be oriented toward the Mercury Mark II project and that paraglider hardware and requirements should be compatible with the Mark II spacecraft. Langley Research Center would support the paraglider program with wind tunnel tests. Flight Research Center would oversee the paraglider flight test program. Coordination of the paraglider program would be the responsibility of Manned Spacecraft Center.

1961
November

Minutes of Meeting of North American Aviation . . . Program Review, Dec. 5, 1961.

On the basis of a report of the Large Launch Vehicle Planning Group, Robert C. Seamans, Jr., NASA Associate Administrator, and John H. Rubel, Department of Defense Deputy Director for Defense Research and Engineering, recommended to Secretary of Defense Robert S. McNamara that the weapon system of the Titan II, with minimal modifications, be approved for the Mercury Mark II rendezvous mission. The planning group had first met in August 1961 to survey the Nation's launch vehicle program and was recalled in November to consider Titan II, Titan II-½, and Titan III. On November 16, McNamara and NASA Administrator James E. Webb had also begun discussing the use of Titan II.

December
5

Memo, Seamans and Rubel to McNamara, Subj: Recommendations Relative to Titan III and II-½, Dec. 5, 1961.

Robert R. Gilruth, Director of the Manned Spacecraft Center, transmitted the procurement plan for the Mark II spacecraft to NASA Headquarters for approval—including scope of work, plans, type of contract administration, contract negotiation and award plan, and schedule of procurement actions. At Headquarters, D. Brainerd Holmes, Director of Manned Space Flight, advised Associate Administrator Robert C. Seamans, Jr., that the extended flight would be conducted in the last half of calendar year 1963 and that the rendezvous flight tests would begin in early 1964. Because of short lead time available to meet the Mark II delivery and launch schedules, it was requested that fiscal year 1962 funds totaling \$75.8 million be immediately released to Manned Spacecraft Center in preparation for the negotiation of contracts for the spacecraft and for the launch vehicle modifications and procurements.

6

Memos, Gilruth to NASA Hqs., Attn: Ernest Brackett, Subj: Transmittal of Procurement Plans for Mark II Spacecraft for Approval, with encs., Dec. 6, 1961; Holmes to Seamans, Subj: Mark II Preliminary Project Development Plan, Dec. 6, 1961, with Seamans' handwritten approval on basic document.

NASA Associate Administrator Robert C. Seamans, Jr., approved the Mark II project development plan. The document approved was accompanied by a memorandum from Colonel Daniel D. McKee of NASA Headquarters stressing the large advances possible in a short time through the Mark II project and their potential application in planned Apollo missions, particularly the use of rendezvous techniques to achieve manned lunar landing earlier than direct ascent would make possible.

7

Memo, Holmes to Seamans, Dec. 6, 1961.

1961
December
7

In Houston, Director Robert R. Gilruth of Manned Spacecraft Center announced plans to develop a two-man Mercury capsule. Built by McDonnell, it would be similar in shape to the Mercury capsule but slightly larger and from two to three times heavier. Its booster would be a modified Titan II. A major program objective would be orbital rendezvous. The two-man spacecraft would be launched into orbit and would attempt to rendezvous with an Agena stage put into orbit by an Atlas. Total cost of 12 capsules plus boosters and other equipment was estimated at \$500 million. The two-man flight program would begin in the 1963-1964 period with several unmanned ballistic flights to test overall booster-spacecraft compatibility and system engineering. Several manned orbital flights would follow. Besides rendezvous flybys of the target vehicle, actual docking missions would be attempted in final flights. The spacecraft would be capable of missions of a week or more to train pilots for future long-duration circumlunar and lunar landing flights. The Mercury astronauts would serve as pilots for the program, but additional crew members might be phased in during the latter portions of the program.

Report of NASA to the House Committee on Science and Aeronautics, *Aeronautical and Astronautical Events of 1961*, 87th Cong., 2d Sess., June 7, 1962, p. 71; *Baltimore Sun*, Dec. 8, 1961.

7

NASA Associate Administrator Robert C. Seamans, Jr., and John H. Rubel, Department of Defense (DOD) Deputy Director for Defense Research and Engineering, offered recommendations to Secretary of Defense Robert S. McNamara on the division of effort between NASA and DOD in the Mark II program. They stressed NASA's primary responsibility for managing and directing the program, although attaining the program objectives would be facilitated by using DOD (especially Air Force) resources in a contractor relation to NASA. In addition, DOD personnel would acquire useful experience in manned space flight design, development, and operations. Space Systems Division of Air Force Systems Command became NASA's contractor for developing, procuring, and launching Titan II and Atlas-Agena vehicles for the Mark II program.

Memo, Seamans and Rubel to McNamara, Subj: Recommendation Relative to the Division of Effort between the NASA and DOD in the Development of Space Rendezvous and Capabilities, Dec. 7, 1961; Howard T. Harris, *Gemini Launch Vehicle Chronology, 1961-1965*, AFSC Historical Publications Series 66-22-1, June 1966, p. 1.

11

NASA laid down guidelines for the development of the two-man spacecraft in a document included as Exhibit "A" in NASA's contract with McDonnell. The development program had five specific objectives: (1) performing Earth-orbital flights lasting up to 14 days, (2) determining the ability of man to function in a space environment during extended missions, (3) demonstrating rendezvous and docking with a target vehicle in Earth orbit as an operational technique, (4) developing simplified countdown procedures and techniques for the rendezvous mission compatible with spacecraft launch vehicle and target vehicle performance, and (5) making controlled land landing the primary recovery mode. The two-man spacecraft would retain the general aerodynamic shape and basic systems concepts of the Mercury spacecraft but would also include several important changes: increased size to accommodate two

1961
December

astronauts; ejection seats instead of the escape tower; an adapter, containing special equipment not needed for reentry and landing, to be left in orbit; housing of most systems hardware outside the pressurized compartment for ease of access; modular systems design rather than integrated; spacecraft systems for orbital maneuvering and docking; and a system for controlled land landing. Target date for completing the program was October 1965.

Letter, Bailey to McDonnell, Subj: Letter Contract No. NAS 9-170, enc. 4, Exhibit "A" to NAS 9-170, Dec. 15, 1961.

Colonel Daniel D. McKee of NASA Headquarters compiled instructions for an Air Force and NASA ad hoc working group established to draft an agreement on the respective responsibilities of the two organizations in the Mark II program. Manned Spacecraft Center (MSC) Director Robert R. Gilruth assigned his special assistant, Paul E. Purser, to head the MSC contingent.

12

Memo, Purser to Gilruth, Subj: Log for the Week of Dec. 11, 1961, Dec. 18, 1961; McKee, "Instructions to Ad Hoc Working Group on the Mercury Mark II," Dec. 12, 1961; "Members of ad hoc working group on Air Force participation in the Mercury Mark II Project," Dec. 13, 1961.

A week after receiving it, McDonnell accepted Letter Contract NAS 9-170 to "conduct a research and development program which will result in the development to completion of a Two-Man Spacecraft." McDonnell was to design and manufacture 12 spacecraft, 15 launch vehicle adapters, and 11 target vehicle docking adapters, along with static test articles and all ancillary hardware necessary to support spacecraft operations. Major items to be furnished by the Government to McDonnell to be integrated into the spacecraft were the paraglider, launch vehicle and facilities, astronaut pressure suits and survival equipment, and orbiting target vehicle. The first spacecraft, with launch vehicle adapter, was to be ready for delivery in 15 months, the remaining 11 to follow at 60-day intervals. Initial Government obligation under the contract was \$25 million.

22

Letter Contract NAS 9-170, Dec. 15, 1961; interviews: Robert N. Lindley, St. Louis, Apr. 13, 1966; Harry W. Oldeg, St. Louis, Apr. 14, 1966.

Manned Spacecraft Center directed Air Force Space Systems Division to authorize contractors to begin the work necessary to use the Titan II in the Mercury Mark II program. On December 27, Martin-Baltimore received a go-ahead on the launch vehicle from the Air Force. A letter contract for 15 Gemini launch vehicles and associated aerospace ground equipment followed on January 19, 1962.

26

Memo, Purser to Gilruth, Subj: Log for the Week of Dec. 25, 1961, Jan. 2, 1962; Harris, *Gemini Launch Vehicle Chronology*, pp. 1, 2.

NASA issued the Gemini Operational and Management Plan, which outlined the roles and responsibilities of NASA and Department of Defense in the Gemini (Mercury Mark II) program. NASA would be responsible for overall program planning, direction, systems engineering, and operation—including Gemini spacecraft development; Gemini/Agena rendezvous and docking equipment development; Titan II/Gemini spacecraft systems integration; launch, flight, and recovery operations; command, tracking, and telemetry during

29

PROJECT GEMINI: A CHRONOLOGY

1961
December

orbital operations; and reciprocal support of Department of Defense space projects and programs within the scope of the Gemini program. Department of Defense would be responsible for: Titan II development and procurement, Atlas procurement, Agena procurement, Atlas-Agena systems integration, launch of Titan II and Atlas-Agena vehicles, range support, and recovery support. A slightly revised version of the plan was signed in approval on March 27 by General Bernard A. Schriever, Commander, Air Force Systems Command, for the Air Force, and D. Brainerd Holmes, Director of Manned Space Flight, for NASA.

"NASA-DOD Operational and Management Plan for the Gemini Program," Dec. 29, 1961; letter, Holmes to Schriever, Jan. 26, 1962; memo, Seamans and Rubel to Secretary of Defense and NASA Administrator, Subj: NASA/DOD Operational and Management Plan for Accomplishing the Gemini (formerly Mercury Mark II) Program, Jan. 29, 1962; Harris, *Gemini Launch Vehicle Chronology*, p. 1.

1962
January
3

"Gemini" became the official designation of the Mercury Mark II program. The name had been suggested by Alex P. Nagy of NASA Headquarters because the twin stars Castor and Pollux in constellation Gemini (the Twins) seemed to him to symbolize the program's two-man crew, its rendezvous mission, and its relation to Mercury. Coincidentally, the astronomical symbol (II) for Gemini, the third constellation of the zodiac, corresponded neatly to the Mark II designation.

Memos, Nagy to George M. Low, Subj: Selection of the Name, Gemini, Dec. 11, 1961; Harold L. Goodwin to Nagy, Subj: Selection of the Name "Gemini," May 3, 1962; Report of NASA to House Committee on Science and Astronautics, *Astronautical and Aeronautical Events of 1962*, 87th Cong., 2nd Sess., June 7, 1963, p. 1.

Figure 11.—The first illustration of the Gemini spacecraft to be released publicly. It was distributed at the same time NASA announced that the project was to be named "Gemini." (NASA Photo S-62-88, released Jan. 3, 1962.)

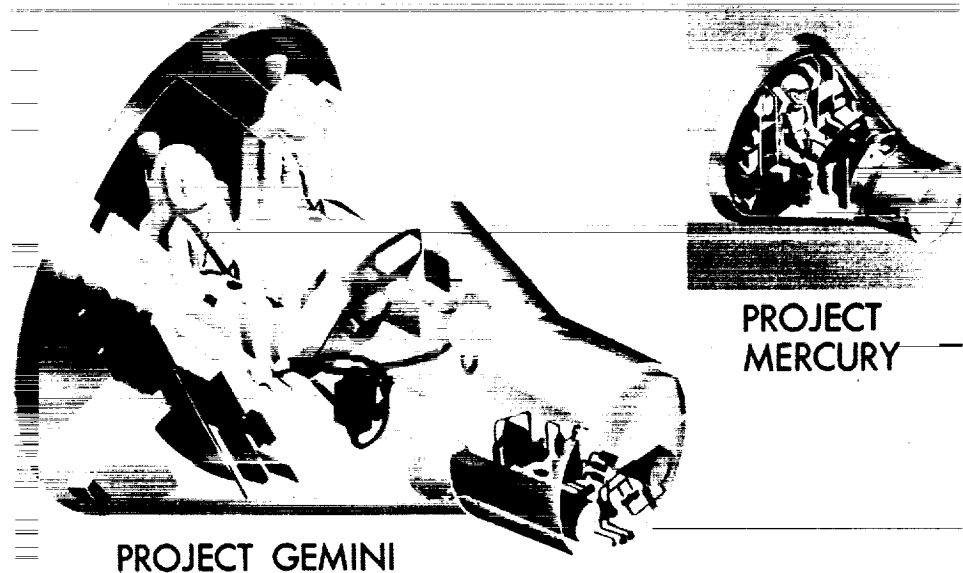

1962
January
3

Manned Spacecraft Center prepared a Statement of Work to be accomplished by Air Force Space Systems Division (SSD) in its role as contractor to NASA for the procurement of Titan II launch vehicles for the Gemini program. The launch vehicle would retain the general aerodynamic shape, basic systems, and propulsion concepts of the missile. Modifications, primarily for crew safety, were to be kept to a minimum. The Statement of Work accompanied a purchase request for \$27 million, dated January 5, 1962, for 15 Titan launch vehicles. Pending ratification of the Gemini Operational and Management Plan, however, funding was limited to \$3 million. To oversee this work, SSD established a Gemini Launch Vehicle Directorate, headed by Colonel Richard C. Dineen, on January 11. Initial budgeting and planning were completed by the end of March, and a final Statement of Work was issued May 14; although amended, it remained in effect throughout the program.

Memo, Purser to Gilruth, Subj: Log for the Week of Jan. 1, 1962, Jan. 8, 1962; Defense Purchase Request No. T-2356-G, Jan. 5, 1962, with Statement of Work, Jan. 3, 1962; Harris, *Gemini Launch Vehicle Chronology*, pp. 1, 2; Bost interview.

Manned Spacecraft Center published its first analysis of the Gemini spacecraft schedule. Potential problem areas in pulse-code-modulated (PCM) telemetry, the bipropellant attitude and control system, and time required to install electrical components and wiring had not yet affected the launch schedule. Scheduled launch dates were adjusted, however, because program approval had come a month later than originally anticipated in the Project Development Plan. The first flight was now planned for late July or early August 1963 with six-week launch centers between the first three flights. Subsequent launches would occur at two-month intervals, with the last flight in late April or early May 1965. The first Agena mission was scheduled for late February or early March 1964.

NASA-MSC, Gemini Project Office, "Project Gemini Schedule Analysis," Jan. 5, 1962.

Director Robert R. Gilruth of Manned Spacecraft Center (MSC) appointed James A. Chamberlin, Chief of Engineering Division, as Manager of Gemini Project Office (GPO). The next day MSC advised McDonnell, by amendment No. 1 to letter contract NAS 9-170, that GPO had been established. It was responsible for planning and directing all technical activities and all contractor activities within the scope of the contract.

Letter, Bailey to McDonnell, Subj: Amendment #1 to Letter Contract NAS 9-170, Jan. 16, 1962; MSC Announcement No. 12, Ref. 2-2, Subj: Personnel Assignments for Mercury and Gemini Program Offices, Jan. 31, 1962; James M. Grimwood, *Project Mercury: A Chronology*, NASA SP-4001, p. 220.

Manned Spacecraft Center completed an analysis of possible power sources for the Gemini spacecraft. Major competitors were fuel cells and solar cells. Although any system selected would require much design, development, and testing effort, the fuel cell designed by General Electric Company, West Lynn, Massachusetts, appeared to offer decided advantages in simplicity, weight, and compatibility with Gemini requirements over solar cells or other fuel cells. A basic feature of the General Electric design, and the source of its advantages over its competitors, was the use of ion-exchange membranes rather than gas-

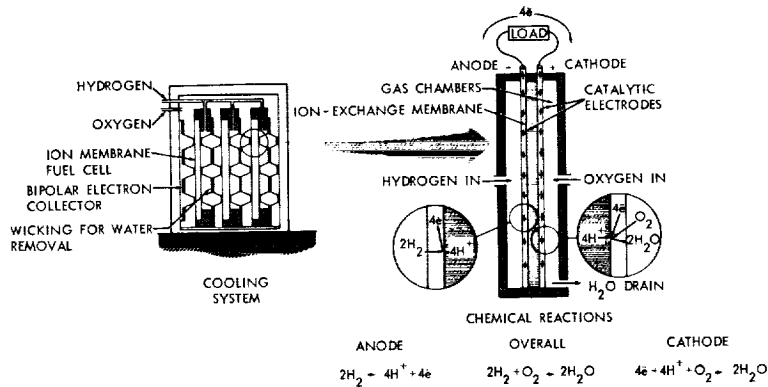

Figure 12.—The operating principle of the fuel cell designed by General Electric, adopted for use in the Gemini spacecraft. (McDonnell, "Project Gemini Familiarization Charts," June 5, 1962, unpagcd.)

1962
January

diffusion electrodes. On March 20, 1962, McDonnell let a \$9 million subcontract to General Electric to design and develop fuel cells for the Gemini spacecraft.

NASA-MSD, Gemini Project Note of January 23, 1962, Subj: Summary of Analysis for Selecting the Power Source for the Gemini Project, Jan. 27, 1962; Procurement and Contracts Division Records, Subj: McDonnell Subcontracts (over \$250,000) as of Dec. 31, 1962.

26

After investigating potential malfunction problems of the modified Titan II/Gemini launch vehicle, Martin-Baltimore prepared a study report with plans to provide the components necessary to ensure flight safety and enhance reliability. Martin defined the malfunction problem quantitatively in terms of the probability of each cause and its characteristic effect on the system and vehicle. Martin intended to keep the launch vehicle as much like the weapon system as possible; thus the data obtained from the Air Force's weapon system development program would be applicable to the launch vehicle. Only minimal modifications to enhance probability of mission success, to increase pilot safety, and to accommodate the Gemini spacecraft as the payload were to be made. These included a malfunction detection system; backup guidance, control, and hydraulic systems; and selective electrical redundancies.

SSD/Martin, *Malfunction Detection System Trade Study—Gemini Program Launch Vehicle*, Jan. 26, 1962; interviews: Guy Cohen, Baltimore, May 24, 1966; Hello; Harris, *Gemini Launch Vehicle Chronology*, pp. 2-4.

31

Manned Spacecraft Center notified Marshall Space Flight Center, Huntsville, Alabama (which was responsible for managing NASA's Agena programs) that Project Gemini required 11 Atlas-Agenas as rendezvous targets and requested Marshall to procure them. The procurement request was accompanied by an Exhibit "A" describing proposed Gemini rendezvous techniques and defining the purpose of Project Gemini as developing and demonstrating Earth-orbit rendezvous techniques as early as possible. If feasible, these techniques could provide a practical base for lunar and other deep space missions. Exhibit B to the purchase request was a Statement of Work for Atlas-Agena vehicles to be used in Project Gemini. Air Force Space Systems Division, acting as a NASA

contractor, would procure the 11 vehicles required. Among the modifications needed to change the Atlas-Agena into the Agena rendezvous vehicle were: incorporation of radar and visual navigation and tracking aids; main engines capable of multiple restarts; addition of a secondary propulsion system, stabilization system, and command system; incorporation of an external rendezvous docking unit; and provision of a jettisonable aerodynamic fairing to enclose the docking unit during launch. The first rendezvous vehicle was to be delivered to the launch site in 20 months, with the remaining 10 to follow at 60-day intervals.

1962
January

Letter, Gilruth to Marshall, Attn: Dr. Werner von Braun, Director, Subj: Procurement of Atlas-Agena Space Vehicles, Jan. 31, 1962, with 2 enc.

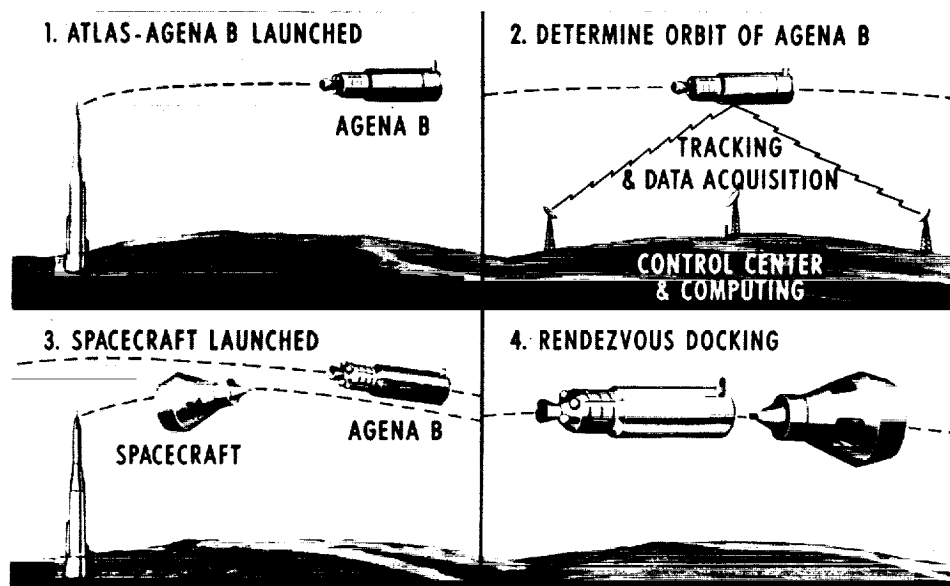

Figure 13.—Four stages in a rendezvous mission as conceived early in 1962. (NASA Photo S-62-82, c. Jan. 3, 1962.)

Air Force Space Systems Division issued a Technical Operating Plan to Aerospace Corporation, El Segundo, California, for support of the Gemini Launch Vehicle Program; a contract followed on March 15. Aerospace was to assume responsibility for general systems engineering and technical direction of the development of the launch vehicle and its associated subsystems. Aerospace had already established a Gemini Launch Vehicle Program Office in January.

February
15

Aerospace, Draft of Annual Report, Fiscal 1962-63, undated; Harris, *Gemini Launch Vehicle Chronology*, pp. 5, 6.

Howard W. Tindall, Jr., Flight Operations Division, requested consolidation of all Gemini computer programming and operation at Manned Spacecraft Center in Houston. The complexity of trajectory control needed for rendezvous, the novelty of computer programming required (a management rather than an arithmetic problem), the lengthy time required for such a program, the need for

19

1962
February

programmers to work with flight controllers, were all reasons to locate this work solely in Houston with no part remaining at Goddard Space Flight Center, Greenbelt, Maryland. Goddard was the primary computing center for Mercury flights. Tindall also recommended a single-source contract with International Business Machines Corporation to equip the facility.

Memo, Tindall to Walter C. Williams, Subj: Consolidation of Gemini Computer Programming and Operation at Houston, Texas, Feb. 19, 1962.

- 19 AiResearch Manufacturing Company, a division of the Garrett Corporation, Los Angeles, California, received a \$15 million subcontract from McDonnell to manufacture the environmental control system (ECS) for the Gemini spacecraft. This was McDonnell's first purchase order in behalf of the Gemini contract. Patterned after the ECS used in Project Mercury (also built by AiResearch), the Gemini ECS consisted of suit, cabin, and coolant circuits, and an oxygen supply, all designed to be manually controlled whenever possible during all phases of flight. Primary functions of the ECS were controlling suit and cabin atmosphere, controlling suit and equipment temperatures, and providing drinking water for the crew and storage or disposal of waste water.

Project Gemini Quarterly Status Report No. 1 for Period Ending May 31, 1962, pp. 15-16; McDonnell Subcontracts (over \$250,000) as of Dec. 31, 1962; Lindley, "Gemini Engineering Program, McDonnell Aircraft Corporation," paper presented to the Institute of Management Sciences, Dallas, Tex., Feb. 16, 1966, pp. 7-8; McDonnell Report F169, *Gemini Final Summary Report*, Feb. 20, 1967, p. 284 (hereafter cited as McDonnell *Final Report*).

- 19 The initial coordination meeting between Gemini Project Office and McDonnell was held at Manned Spacecraft Center, Houston. Gemini Project Manager James A. Chamberlin and McDonnell Engineering Manager Robert N. Lindley outlined statements of policy. The purpose of subsequent coordination meetings was to discuss and settle problems arising between McDonnell and NASA. These coordination meetings were the central focus of decision-making during the development phase of the Gemini program. After five indoctrination meetings (February 19, 21, 23, 27, and 28), during which McDonnell representatives described spacecraft systems, regular business meetings began on March 5; subsequent meetings were tentatively scheduled for Monday, Wednesday, and Friday of each week.

Minutes of . . . McDonnell Coordination Meeting, Feb. 26, 1962; Minutes of NASA Project Office-McDonnell Coordination Meeting, Mar. 6, 1962; interview, Andre J. Meyer, Jr., Houston, Jan. 6, 1967.

- 20 McDonnell issued specifications for the crew-station system for the Gemini spacecraft. The crew-station system would include displays of spacecraft system functions, controls for spacecraft systems, and the means of integrating two crew members into the system. The specifications also established areas of responsibility for each crew member.

McDonnell Report 8635, *Gemini Spacecraft—Crew Station System Specification*, Feb. 20, 1962, rev. July 13, 1962.

- 22 Martin-Baltimore submitted its initial proposal for the redundant flight control and hydraulic subsystems for the Gemini launch vehicle; on March 1, Martin was authorized to proceed with study and design work. The major change in

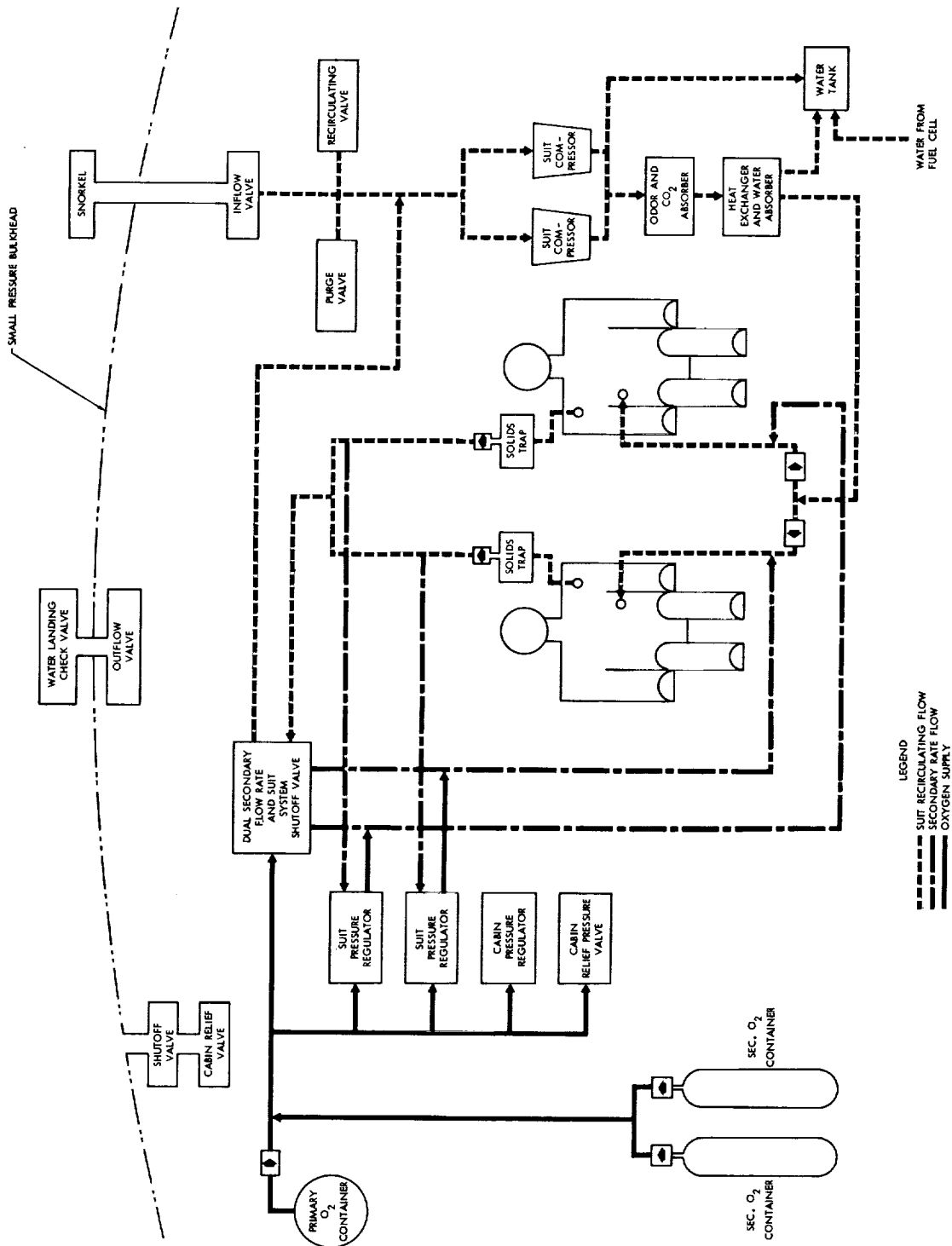

Figure 14.—Block diagram of the Gemini environmental control system, subcontracted by McDonnell to AiResearch Manufacturing Co. (McDonnell, "Project Gemini Familiarization Charts," June 5, 1962, unpagged.)

1962
February

the flight control system from Titan II missile to Gemini launch vehicle was substitution of the General Electric Mod IIIIG radio guidance system (RGS) and Titan I three-axis reference system for the Titan II inertial guidance system. Air Force Space Systems Division issued a letter contract to General Electric Company, Syracuse, New York, for the RGS on June 27. Technical liaison, computer programs, and ground-based computer operation and maintenance were contracted to Burroughs Corporation, Paoli, Pennsylvania, on July 3.

Conclusion of Meeting of NASA, SSD, Martin, McDonnell, Mar. 2, 1962; Harris, *Gemini Launch Vehicle Chronology*, pp. 5, 9.

24

McDonnell let a \$32 million subcontract to North American Aviation's Rocketdyne Division, Sacramento, California, to build liquid propulsion systems for the Gemini spacecraft. Two separate systems were required: the orbit attitude and maneuvering system (OAMS) and the reaction or reentry control system (RCS). The OAMS, located in the adapter section, had four functions: (1) providing the thrust required to enable the spacecraft to rendezvous with the target vehicle; (2) controlling the attitude of the spacecraft in orbit; (3) separating the spacecraft from the second stage of the launch vehicle and

Figure 15.—The general arrangement of liquid rocket systems (OAMS and RCS) in the Gemini spacecraft. The insert displays a typical thrust chamber assembly. (McDonnell, "Project Gemini Familiarization Charts," June 5, 1962, unpag.)

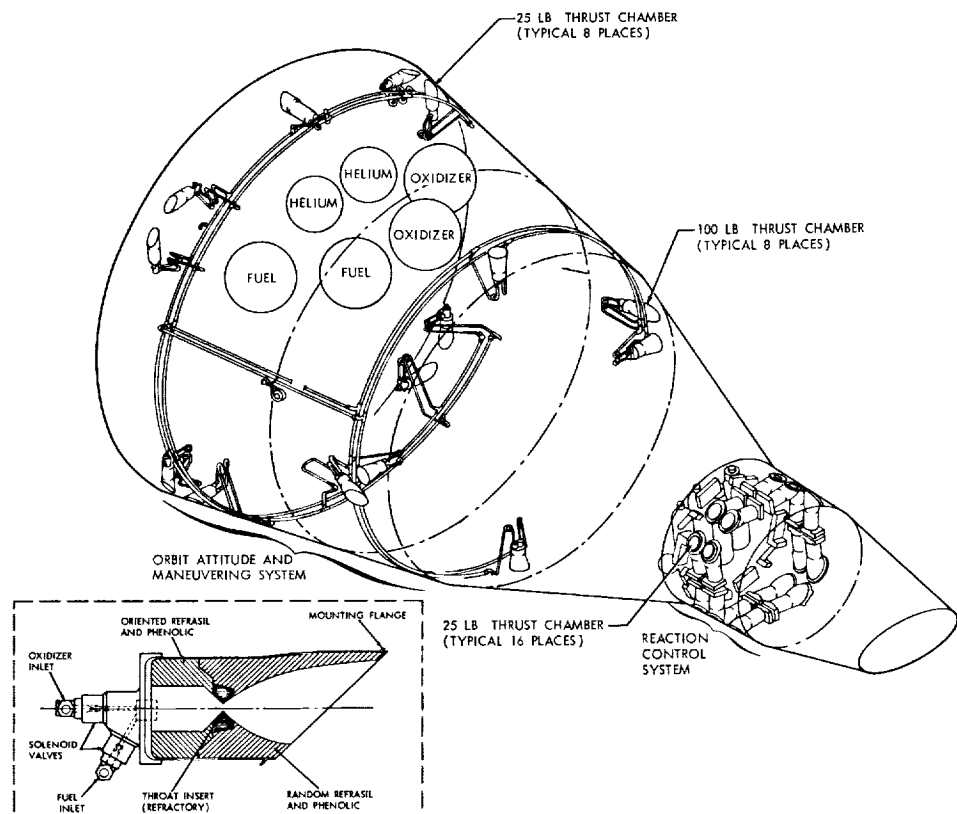

inserting it in orbit; and (4) providing abort capability at altitudes between 300,000 feet and orbital insertion. The OAMS initially comprised 16 ablative thrust chambers; eight 25-pound thrusters to control spacecraft attitude in pitch, yaw, and roll axes; and eight 100-pound thrusters to maneuver the spacecraft axially, vertically, and laterally. Rather than providing a redundant system, only critical components were to be duplicated. The RCS was located forward of the crew compartment in an independent RCS module. It consisted of two completely independent systems, each containing eight 25-pound thrusters very similar to those used in the OAMS. Purpose of the RCS was to maintain the attitude of the spacecraft during the reentry phase of the mission.

1962
February

Quarterly Status Report No. 1, pp. 12, 20; McDonnell Subcontracts (over \$250,000) as of Dec. 31, 1962.

Representatives of McDonnell, North American, Manned Spacecraft Center, and NASA Headquarters met to begin coordinating the interface between spacecraft and paraglider. The first problem was to provide adequate usable stowage volume for the paraglider landing system within the spacecraft. The external geometry of the spacecraft had already been firmly established, so the problem narrowed to determining possible volumetric improvements within the spacecraft's recovery compartment.

28

Abstract of Meeting on Spacecraft-Paraglider Interface, Mar. 2, 1962.

Manned Spacecraft Center (MSC) suballotted \$5.2 million to Marshall Space Flight Center for procuring Atlas-Agena vehicles for Project Gemini. Marshall was to spend no more than \$2 million, however, until a Statement of Work had been made definite. Regularly scheduled meetings were planned to resolve technical and management problems between MSC and Marshall. The first Atlas-Agena launch under this program was expected to take place on or about March 15, 1964.

28

Minutes of Meeting of Gemini Project Office and MSFC-Agena Project Office, Mar. 5, 1962.

Harold I. Johnson, Head of the Spacecraft Operations Branch of Manned Spacecraft Center's Flight Crew Operations Division, circulated a memorandum on proposed training devices for Project Gemini. A major part of crew training depended on several different kinds of trainers and simulators corresponding to various aspects of proposed Gemini missions. Overall training would be provided by the flight simulator, capable of simulating a complete mission profile including sight, sound, and vibration cues. Internally identical to the spacecraft, the flight simulator formed part of the mission simulator, a training complex for both flight crews and ground controllers that also included the mission control center and remote site displays. Training for launch and reentry would be provided by the centrifuge at the Naval Air Development Center, Johnsville, Pennsylvania. A centrifuge gondola would be equipped with a mock-up of the Gemini spacecraft's interior. A static article spacecraft would serve as an egress trainer, providing flight crews with the opportunity to practice normal and emergency methods of leaving the spacecraft after landings on either land or water. To train flight crews in land landing, a boilerplate spacecraft equipped with a full-scale paraglider wing would be used in a flight program consisting

March
5

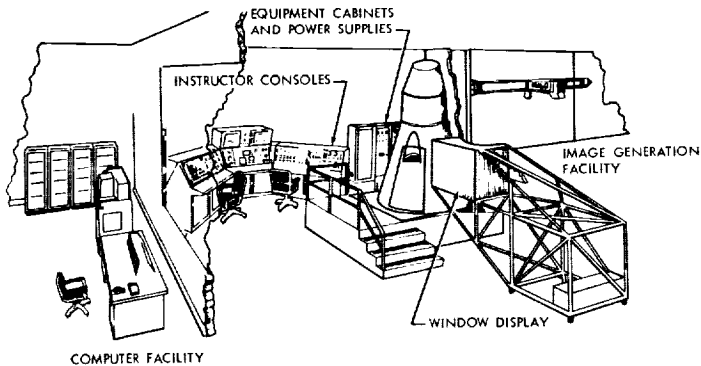

(A)

Figure 16.—The two major types of simulators to be used in training crews for Gemini missions. (A) The Gemini flight trainer would simulate the entire mission, while (B) the docking trainer would simulate the final stages of rendezvous. (McDonnell, "Project Gemini Familiarization Charts," June 5, 1962, unpagged.)

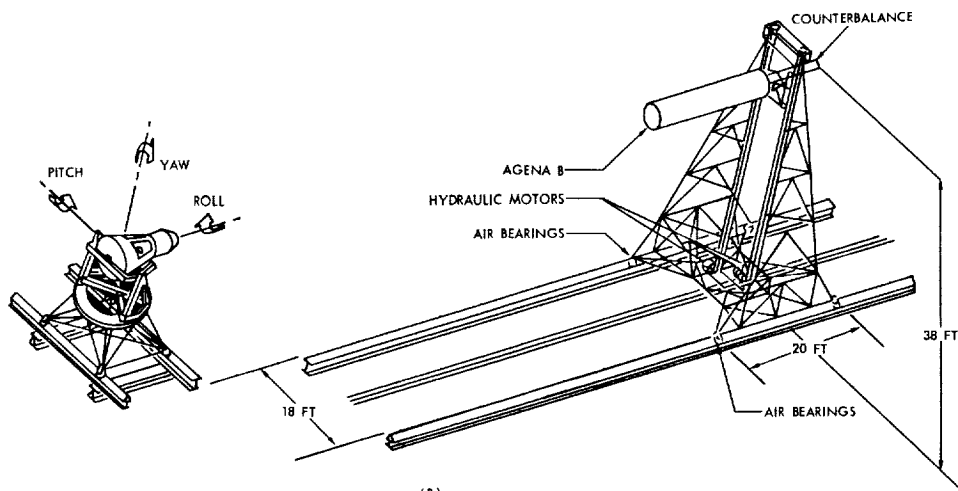

(B)

1962
March

of drops from a helicopter. A docking trainer, fitted with actual docking hardware and crew displays and capable of motion in six degrees of freedom, would train the flight crew in docking operations. Other trainers would simulate major spacecraft systems to provide training in specific flight tasks.

Memo, Johnson for All Concerned, Subj: Preliminary Description of Simulators and Training Equipment Expected to be used in Project Gemini, Mar. 5, 1962; Quarterly Status Report No. 1, pp. 38-39.

5

Westinghouse Electric Corporation, Baltimore, Maryland, received a \$6.8 million subcontract from McDonnell to provide the rendezvous radar and transponder system for the Gemini spacecraft. Purpose of the rendezvous radar, sited in the recovery section of the spacecraft, was to locate and track the target vehicle during rendezvous maneuvers. The transponder, a combined receiver and transmitter designed to transmit signals automatically when triggered by an interrogating signal, was located in the Agena target vehicle.

Quarterly Status Report No. 1, pp. 6, 17, 27-28; McDonnell Subcontracts (over \$250,000) as of Dec. 31, 1962.

1962
March

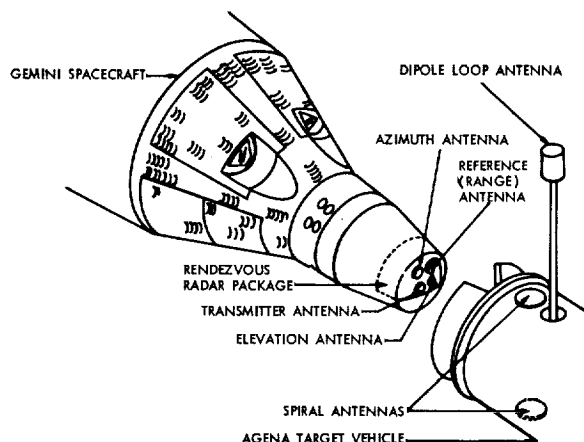

Figure 17.—The location of the main elements of the rendezvous radar system on the Gemini spacecraft and the Agena target vehicle. (Charts presented by R. R. Carley (Gemini Project Office), "Project Gemini Familiarization Briefing," July 9-10, 1962.)

McDonnell awarded a \$6.5 million subcontract to Minneapolis-Honeywell Regulator Company, Minneapolis, Minnesota, to provide the attitude control and maneuvering electronics system for the Gemini spacecraft. This system commanded the spacecraft's propulsion systems, providing the circuitry which linked the astronaut's operation of his controls to the actual firing of thrusters in the orbit attitude and maneuvering system or the reaction control system.

7

Quarterly Status Report No. 1, p. 18; McDonnell Subcontracts (over \$250,000) as of Dec. 31, 1962; McDonnell *Final Report*, pp. 202-204.

Figure 18.—A functional block diagram of the attitude control and maneuvering electronics system of the Gemini spacecraft. (McDonnell, "Project Gemini Familiarization Charts," June 5, 1962, unpagged.)

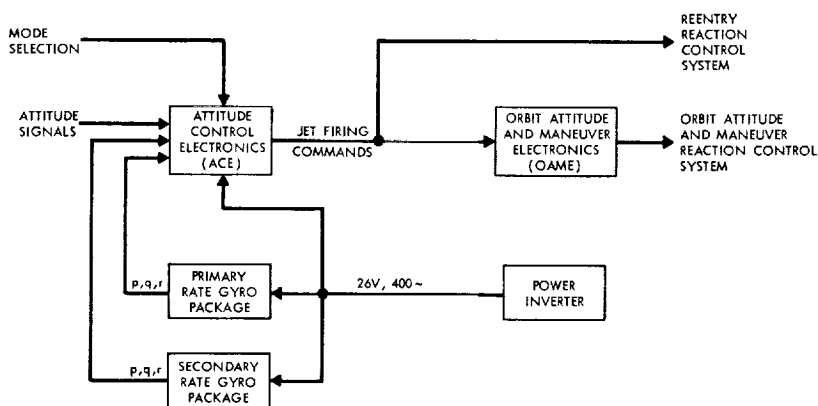

1962
March
7

Gemini Project Office accepted McDonnell's preliminary design of the spacecraft's main undercarriage for use in land landings and authorized McDonnell to proceed with detail design. Dynamic model testing of the undercarriage was scheduled to begin about April 1.

Abstract of Meeting on Mechanical Systems, Mar. 9, 1962.

- 8 Manned Spacecraft Center directed North American to design and develop an emergency parachute recovery system for both the half-scale and full-scale flight test vehicles required by Phase II-A of the Paraglider Development Program and authorized North American to subcontract the emergency recovery system to Northrop Corporation's Radioplane Division, Van Nuys, California. North American awarded the \$225,000 subcontract to Radioplane on March 16. This was one of two major subcontracts let by North American for Phase II-A. The other, for \$227,000, went to Goodyear to study materials and test fabrics for inflatable structures.

Figure 19.—Gemini landing gear: part of the land landing system along with the paraglider. (McDonnell, "Project Gemini Familiarization Charts," June 5, 1962, unpagged.)

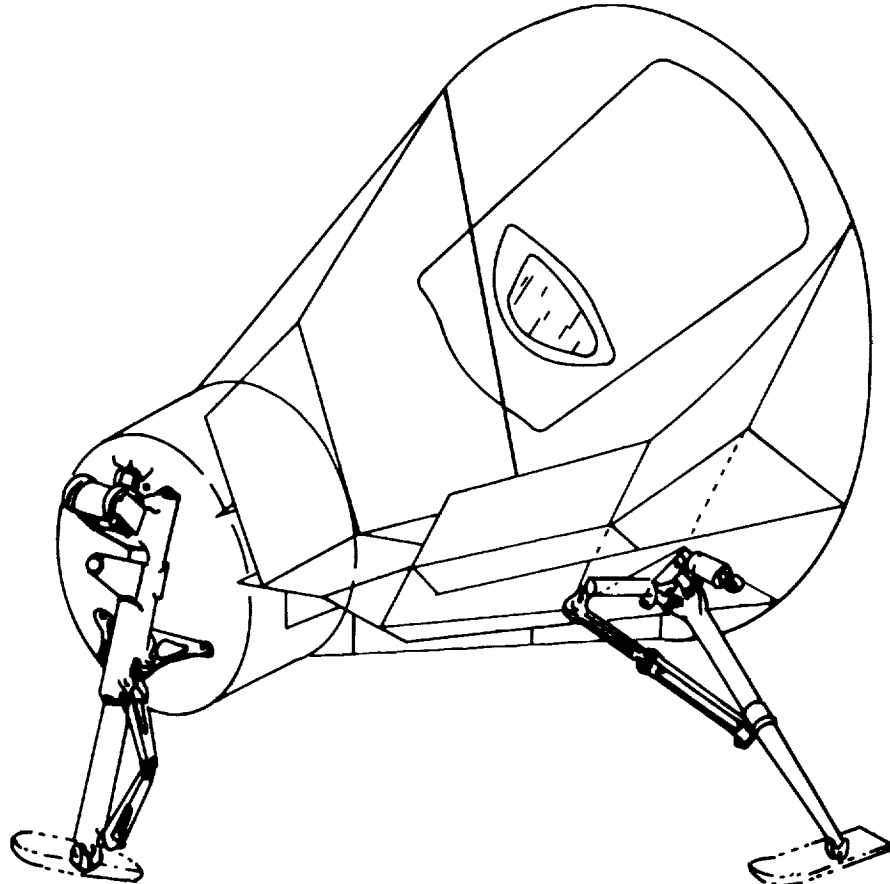

Message, Bailey to NAA-SID, Mar. 8, 1962; memo, Robert L. Kline to H. L. Watkins, Subj: Renegotiation Board Information for Contract NAS 9-167, Aug. 17, 1963; Change Notice No. 1, NAS 9-167, Mar. 8, 1962; NAA letter 62MA3530, Subj: Contract NAS 9-167, Paraglider Development Program, Phase II-A, Monthly Progress Letter No. 4, Mar. 29, 1962.

1962
March

Marshall Space Flight Center delivered an Agena procurement schedule (dated March 8) to Gemini Project Office. Air Force Space Systems Division (SSD) was to contract with Lockheed for 11 target vehicles. SSD assigned the Gemini Agena target vehicle program to its Ranger Launch Directorate, which was responsible for programs using Agena vehicles. Marshall also reported the expected delivery of a qualified multiple-restart main engine in 50 weeks, an improvement that removed this development requirement as the pacing item in Agena scheduling.

12

Abstract of Meeting on Atlas-Agena Coordination, Mar. 12, 1962; interview, Maj. Arminta Harness, Los Angeles, Apr. 18, 1966.

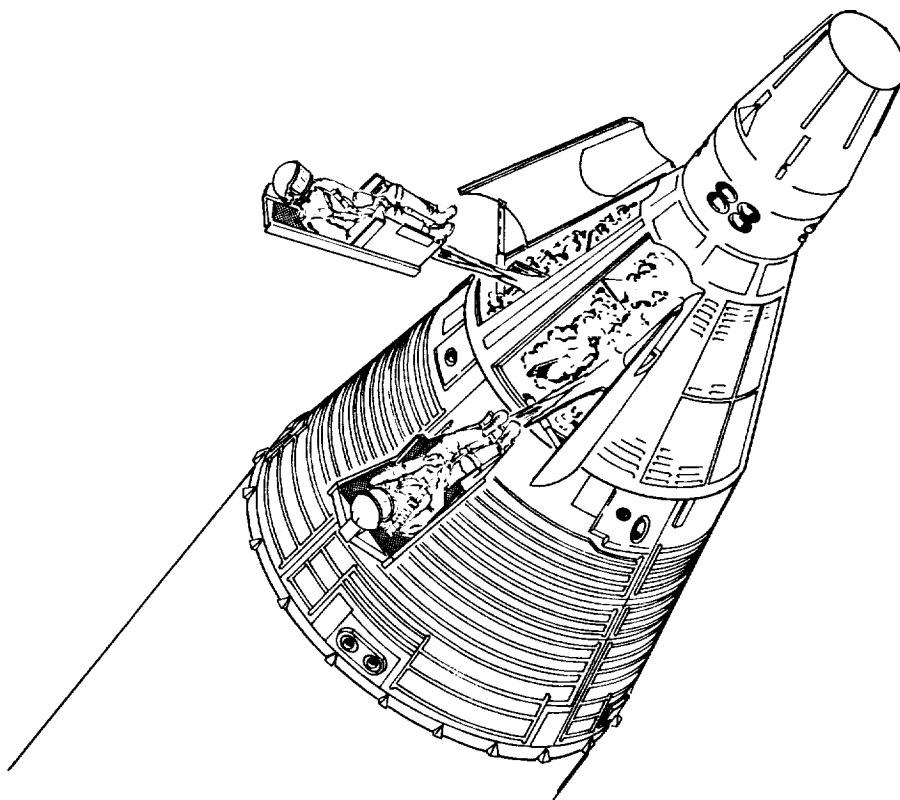

Figure 20.—An artist's version of the use of ejection seats to escape from the Gemini spacecraft. The seats were to be used before launch (off-the-pad abort) or during the first phase of powered flight (to about 60,000 feet) if the launch vehicle malfunctioned. (McDonnell, "Project Gemini Familiarization Charts," June 5, 1962, unpagged.)

Gemini Project Office (GPO) decided that seat ejection was to be initiated manually, with the proviso that the design must allow for the addition of automatic initiation if this should later become a requirement. Both seats had to eject simultaneously if either seat ejection system was energized. The ejection seat

14

1962
March

was to provide the flight crew a means of escaping from the Gemini spacecraft in an emergency while the launch vehicle was still on the launch pad, during the initial phase of powered flight (to about 60,000 feet), or in case of paraglider failure after reentry. In addition to the seat, the escape system included a hatch actuation system to open the hatches before ejection, a rocket catapult to propel the seat from the spacecraft, a personnel parachute system to sustain the astronaut after his separation from the seat, and survival equipment for the astronaut's use after landing. At a meeting on March 29, representatives of McDonnell, GPO, Life Systems Division, and Flight Crew Operations Division agreed that a group of specialists should get together periodically to monitor the development of the ejection seat, its related components, and the attendant testing. Although ejection seats had been widely used in military aircraft for years, Gemini requirements, notably for off-the-pad abort capability, were beyond the capabilities of existing flight-qualified systems. McDonnell awarded a \$1.8 million subcontract to Weber Aircraft at Burbank, California, a division of Walter Kidde and Company, Inc., for the Gemini ejection seats on April 9; a \$741,000 subcontract went to Rocket Power, Inc., Mesa, Arizona, on May 15 for the escape system rocket catapult.

Quarterly Status Report No. 1, pp. 20-21; McDonnell Subcontracts (over \$250,000) as of Dec. 31, 1962; Abstracts of Meetings on: Mechanical Systems, Mar. 15 and Apr. 12, 1962; Ejection Seats, Apr. 3, 1962; McDonnell *Final Report*, p. 361.

- 14 Manned Spacecraft Center issued its second analysis of the Gemini program schedule. Unlike the first, it considered launch vehicles as well as the spacecraft. Procurement of the Agena target vehicle had been initiated so recently that scope for analysis in that area was limited. A key feature of engineering development for the Gemini program was the use of a number of test articles, the lack of which had sometimes delayed the Mercury program; although constructing these test articles might cause some initial delay in Gemini spacecraft construction, the data they would provide would more than compensate for any delay. No problems beset launch vehicle development, but the schedule allowed little contingency time for unexpected problems. The first unmanned qualification flight was still scheduled for late July or early August 1963, but the second (manned) flight was now planned for late October or early November 1963 and the first Agena flight for late April or early May 1964, with remaining flights to follow at two-month intervals, ending in mid-1965. Flight missions remained unchanged from the January analysis.

NASA-MSC, Gemini Project Office, "Project Gemini Schedule Analysis," Mar. 14, 1962.

- 15 Gemini Project Office restated its intention to use Project Mercury hardware and subcontractors for Gemini. Justification for using different equipment or subcontractors was required for each item.

Abstract of . . . Coordination Meeting (Electrical), Mar. 15, 1962.

- 16 The Air Force successfully launched a Titan II intercontinental ballistic missile. This was the first full-scale test of the vehicle; it flew 5000 miles out over the Atlantic Ocean.

NASA *Seventh Semiannual Report to Congress, January 1, 1962-June 30, 1962*, pp. 22-23.

McDonnell awarded AiResearch a \$5.5 million subcontract to provide the reactant supply system for the Gemini spacecraft fuel cells. The oxygen and hydrogen required by the fuel cell were stored in two double-walled, vacuum-insulated, spherical containers located in the adapter section of the spacecraft. Reactants were maintained as single-phase fluids (neither gas nor liquid) in their containers by supercritical pressures at cryogenic temperatures. Heat exchangers converted them to gaseous form and supplied them to the fuel cells at operating temperatures.

1962
March
17

McDonnell Subcontracts (over \$250,000) as of Dec. 31, 1962; McDonnell *Final Report*, p. 104.

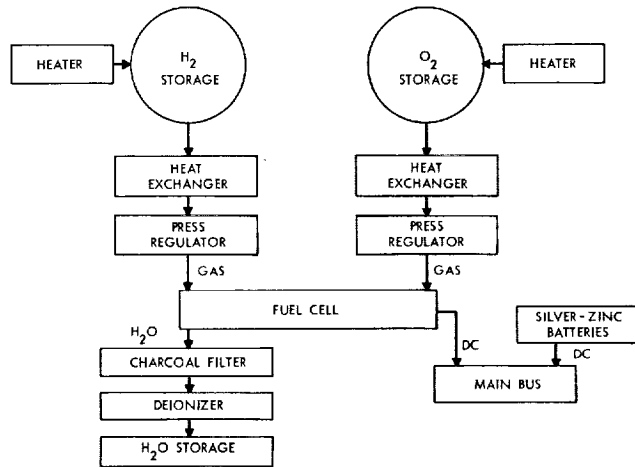

Figure 21.—Block diagram of the reactant supply system for the Gemini spacecraft fuel cells. (MSC Flight Crew Operations Division, Crew Engineering, "Gemini Familiarization Package," Aug. 3, 1962.)

Advanced Technology Laboratories, Inc., Mountain View, California, received a \$3.2 million subcontract from McDonnell to provide the horizon sensor system for the Gemini spacecraft. Two horizon sensors, one primary and one standby, were part of the spacecraft's guidance and control system. They scanned, detected, and tracked the infrared radiation gradient between Earth

19

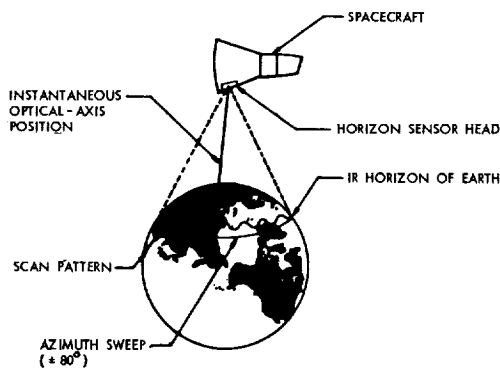

Figure 22.—Illustrating the operation of the horizon sensor for the Gemini spacecraft. (McDonnell, "Project Gemini Familiarization Charts," June 5, 1962, unpagged.)

1962
March

and space (Earth's infrared horizon) to provide reference signals for aligning the inertial platform and error signals to the attitude control and maneuver electronics for controlling the spacecraft's attitude about its pitch and roll axes.

Quarterly Status Report No. 1, p. 18; McDonnell Subcontracts (over \$250,000) as of Dec. 31, 1962; McDonnell *Final Report*, pp. 213-214; McDonnell External Relations Division, *Gemini Press Reference Book: Gemini Spacecraft Number Three*, undated, p. 38.

19

Thiokol Chemical Corporation, Elkton, Maryland, received a \$400,000 subcontract from McDonnell to provide the retrograde rockets for the Gemini spacecraft. Only slight modification of a motor already in use was planned, and a modest qualification program was anticipated. Primary function of the solid-propellant retrorockets, four of which were located in the adapter section, was to decelerate the spacecraft at the start of the reentry maneuver. A secondary function was to accelerate the spacecraft to aid its separation from the launch vehicle in a high-altitude, suborbital abort.

Quarterly Status Report No. 1, p. 11; A. H. Atkinson, "Gemini—Major Subcontracts, McDonnell Aircraft Corporation," July 3, 1962; McDonnell *Final Report*, pp. 278-279.

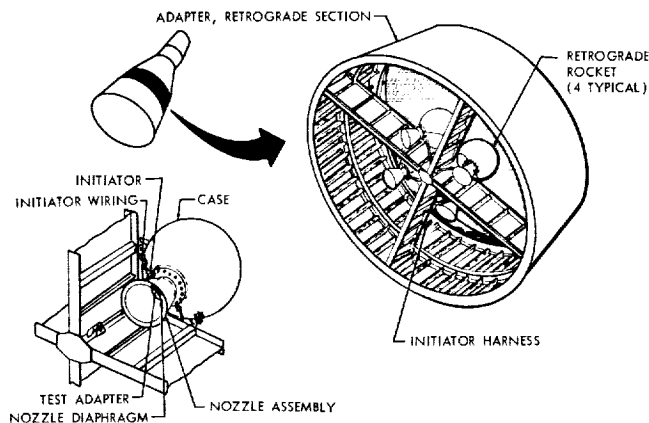

Figure 23.—Location and arrangement of the retrograde rocket system in the Gemini spacecraft. (McDonnell, "Project Gemini Familiarization Charts," June 5, 1962, unpagged.)

21

Air Force Space Systems Division awarded a letter contract to Aerojet-General Corporation, Azusa, California, for the research, development, and procurement of 15 propulsion systems for the Gemini launch vehicle, as well as the design and development of the related aerospace ground equipment. Aerojet had been authorized to go ahead with work on the engines on February 14, 1962, and the final engine was scheduled for delivery by April 1965.

Harris, *Gemini Launch Vehicle Chronology*, p. 6.

21

McDonnell awarded a \$4.475 million subcontract to the Western Military Division of Motorola, Inc., Scottsdale, Arizona, to design and build the digital command system (DCS) for the Gemini spacecraft. Consisting of a receiver/decoder package and three relay packages, the DCS received digital commands

1962
March

transmitted from ground stations, decoded them, and transferred them to the appropriate spacecraft systems. Commands were of two types: real-time commands to control various spacecraft functions and stored program commands to provide data updating the time reference system and the digital computer.

Quarterly Status Report No. 1, pp. 25–26; McDonnell Subcontracts (over \$250,000) as of Dec. 31, 1962; McDonnell *Final Report*, pp. 166–167.

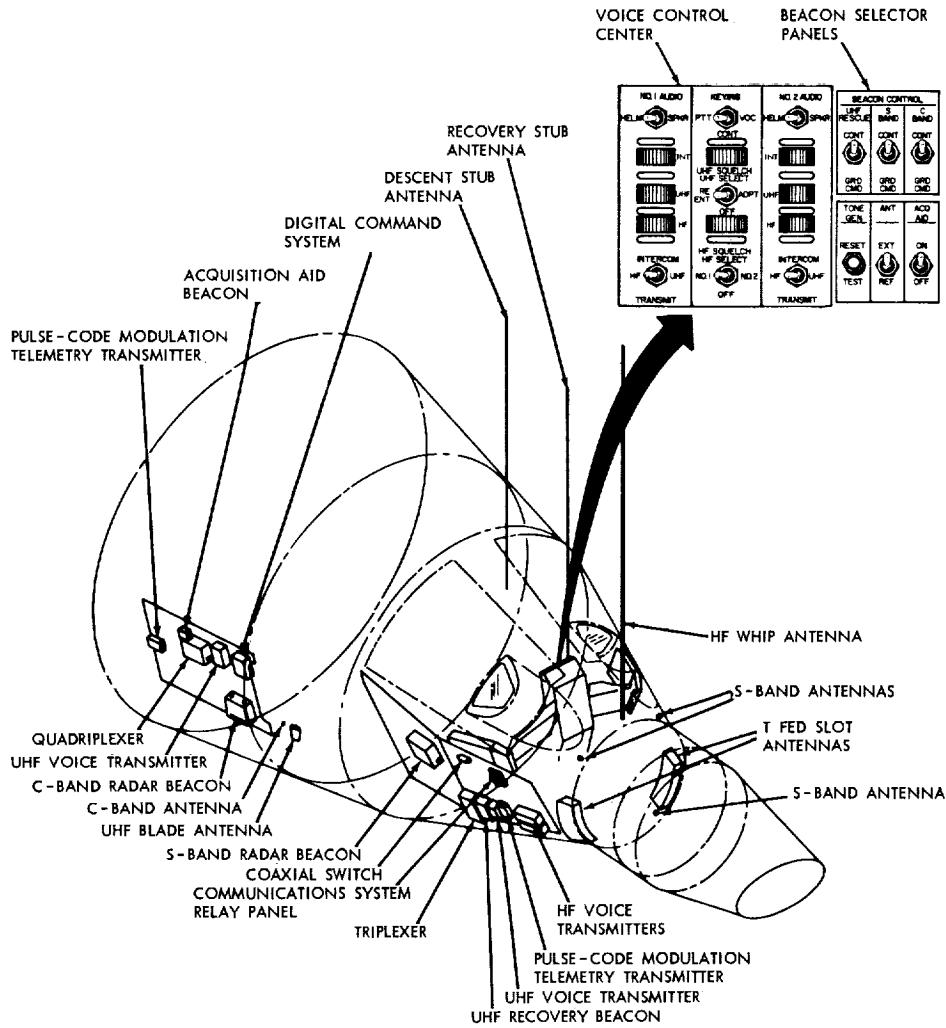

Figure 24.—Gemini spacecraft communications system, which received ground commands for transfer to spacecraft systems. (McDonnell, "Project Gemini Familiarization Manual: Manned Spacecraft, Rendezvous Configuration," SEDR 300, June 1, 1962, p. 8-1.)

Air Force Space Systems Division published the "Development Plan for the Gemini Launch Vehicle System." From experience in Titan II and Mercury programs, the planners estimated a budget of \$164.4 million, including a 50 percent contingency for cost increases and unforeseen changes.

Harris, *Gemini Launch Vehicle Chronology*, p. 6.

1962
March
28

McDonnell awarded a \$2.5 million subcontract to Collins Radio Company, Cedar Rapids, Iowa, to provide the voice communications systems for the Gemini spacecraft. Consisting of the voice control center on the center instrument panel of the spacecraft, two ultrahigh-frequency voice transceivers, and one high-frequency voice transceiver, this system provided communications between the astronauts, between the blockhouse and the spacecraft during launch, between the spacecraft and ground stations from launch through reentry, and between the spacecraft and recovery forces after landing.

Quarterly Status Report No. 1, p. 25; McDonnell Subcontracts (over \$250,000) as of Dec. 13, 1962; McDonnell *Final Report*, p. 131.

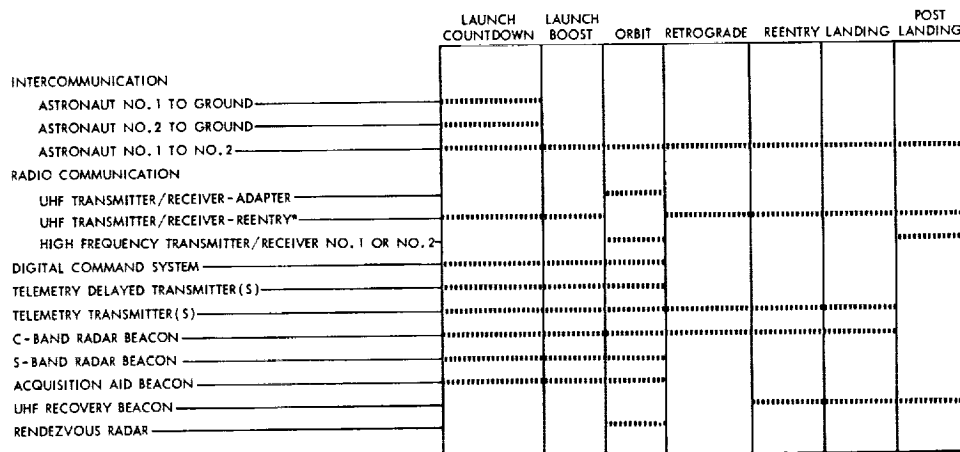

* UHF TRANSMITTER/RECEIVER-REENTRY SERVES AS A RESERVE BACKUP FOR UHF TRANSMITTER/RECEIVER-ADAPTER DURING ORBIT

Figure 25.—Illustrating the stages of a mission during which various elements of the Gemini spacecraft communications system would be used. (Charts presented by J. Hoffman (GPO), "Project Gemini Familiarization Briefing," July 9-10, 1962.)

29

The St. Petersburg, Florida, Aeronautical Division of Minneapolis-Honeywell received an \$18 million subcontract from McDonnell to provide the inertial measuring unit (IMU) for the Gemini spacecraft. The IMU was a stabilized inertial platform including an electronic unit and a power supply. Its primary functions were to provide a stable reference for determining spacecraft attitude and to indicate changes in spacecraft velocity.

Quarterly Status Report No. 1, p. 17; McDonnell Subcontracts (over \$250,000) as of Dec. 31, 1962; McDonnell *Final Report*, p. 195; McDonnell *Gemini Press Reference Book*, pp. 31-32.

30

Martin-Baltimore submitted a "Description of the Launch Vehicle for the Gemini Spacecraft" to Air Force Space Systems Division. This document laid the foundation for the design of the Gemini launch vehicle by defining the concept and philosophy of each proposed subsystem.

Martin Report ER-12209, "Description of the Launch Vehicle for the Gemini Spacecraft," Rev. A, Mar. 30, 1962; Harris, *Gemini Launch Vehicle Chronology*, p. 7.

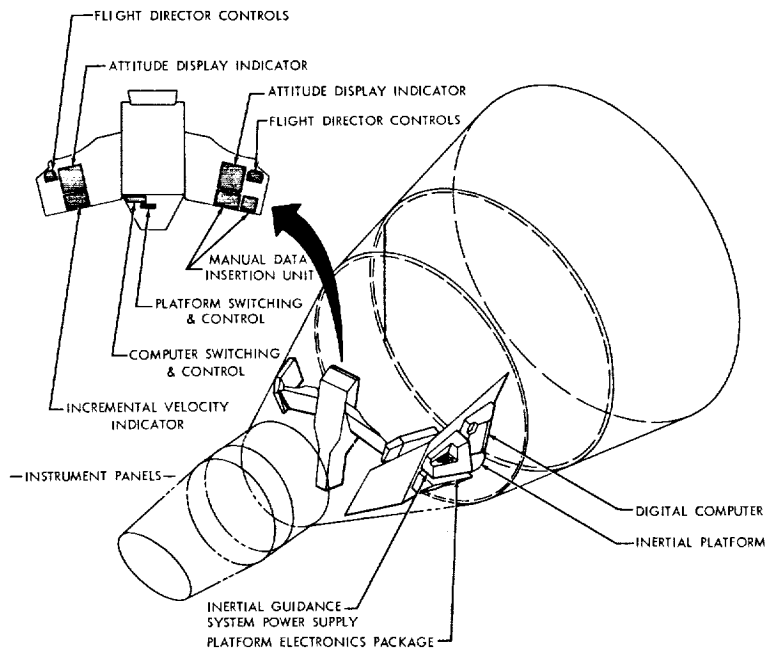

Figure 26.—The Gemini spacecraft inertial guidance system. (McDonnell, "Project Gemini Familiarization Manual: Manned Spacecraft Rendezvous Configuration," SEDR 300, June 1, 1962, p. 7-23.)

The configuration of the Gemini spacecraft was formally frozen. Following receipt of the program go-ahead on December 22, 1961, McDonnell began defining the Gemini spacecraft. At that time, the basic configuration was already firm. During the three-month period, McDonnell wrote a series of detail specifications to define the overall vehicle, its performance, and each of the major subsystems. These were submitted to NASA and approved. During the same period, the major subsystems specification control drawings—the specifications against which equipment was procured—were written, negotiated with NASA, and distributed to potential subcontractors for bid.

1962
March
31

Lindley, "Gemini Engineering Program," pp. 7-8.

Representatives of Manned Spacecraft Center, Ames Research Center, Martin, and McDonnell met to discuss the participation of Ames in the Gemini wind tunnel program. The tests were designed to determine: (1) spacecraft and launch vehicle loads and the effect of the hatches on launch stability, using a six percent model of the spacecraft and launch vehicle; (2) the effect of large angles of attack, Reynold's number, and retrorocket jet effects on booster tumbling characteristics and attachment loads; (3) exit characteristics of the spacecraft; and (4) reentry characteristics of the reentry module.

April
3

Minutes of Coordination Meeting on Gemini Wind Tunnel Program, Apr. 9, 1962.

Manned Spacecraft Center awarded the Aerospace and Defense Products Division of B. F. Goodrich Company, Akron, Ohio, a cost-plus-fixed-fee contract for \$209,701 to design, develop, and fabricate prototype pressure suits. Related

4

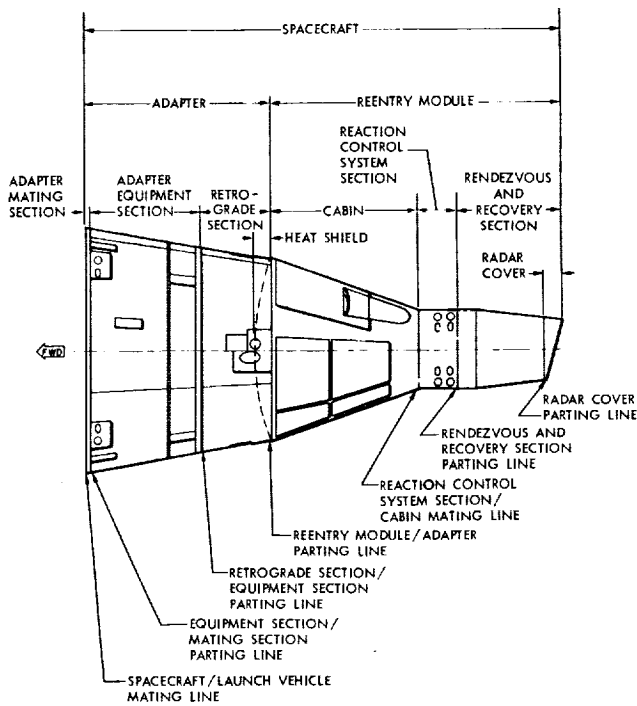

Figure 27.—Gemini spacecraft nomenclature. (McDonnell, "Project Gemini Familiarization Manual: Manned Spacecraft Rendezvous Configuration," SEDR 300, June 1, 1962, p. 2-3.)

1962
April

contracts went to Arrowhead Products Division of Federal-Mogul Corporation, Los Alamitos, California, and Protection, Inc., Gardena, California. B. F. Goodrich had begun work related to the contract on January 10, 1962. The contract covered two separate pressure suit development programs, neither of them initially identified with a particular manned space flight program. The original Statement of Work required B. F. Goodrich to produce four successively improved prototypes of an advanced full-pressure suit, and two prototypes of a partial-wear, quick-assembly, full-pressure suit. The contract was amended on September 19, 1962, to identify the development programs specifically with Project Gemini.

Procurement and Contracts Division Weekly Activity Report, Mar. 5-9, 1962;
B. F. Goodrich, "Design, Development, and Fabrication of Prototype Pressure Suits Final Report," Feb. 1, 1965 (hereafter cited as "Goodrich Final Report").

7

ACF Electronics Division, Riverdale, California, of ACF Industries, Inc., received a \$1 million subcontract from McDonnell to provide C- and S-band radar beacons for the Gemini spacecraft. These beacons formed part of the spacecraft's tracking system. With the exception of frequency-dependent differences, the C-band beacon was nearly identical to the S-band beacon. Their function was to provide tracking responses to interrogation signals from ground stations.

McDonnell Subcontracts (over \$250,000) as of Dec. 31, 1962; McDonnell *Final Report*, pp. 149-150; McDonnell *Gemini Press Reference Book*, p. 21.

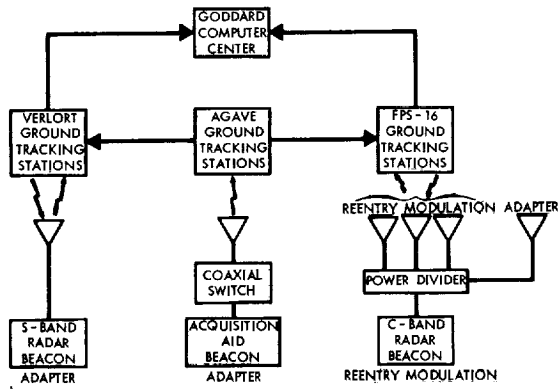

Figure 28.—Gemini spacecraft tracking aids (beacon system). (McDonnell, "Project Gemini Familiarization Charts," June 5, 1962, unpagged.)

Earl Whitlock of McDonnell presented a "Gemini Manufacturing Plan" (dated April 6) to Gemini Project Office (GPO). The schedule called for production spacecraft No. 1 to be followed by static article No. 1. Because of the normally poor quality of a first production item, GPO asked McDonnell to start static article No. 1 first on or about May 15, 1962, while leaving spacecraft No. 1 where it was in the schedule. McDonnell's contract called for four static articles, ground test units similar in construction to, and using the same material as, flight articles.

1962
April
9

Abstract of . . . Coordination Meeting (Manufacturing), Apr. 12, 1962.

Manned Spacecraft Center confirmed that a five-day orbital lifetime of Agena systems would be adequate for currently planned missions.

12

Abstract of Agena/Spacecraft Interface Meeting, Apr. 13, 1962.

Martin-Baltimore and Air Force Space Systems Division (SSD) reported to Gemini Project Office on the problems of establishing abort criteria for the malfunction detection system (MDS). Manned Spacecraft Center had formed a task force of Martin, McDonnell, and Aerospace personnel to begin a maximum effort to define overall abort criteria. On April 23, Martin submitted to SSD its descriptive study and proposed configuration of the MDS, intended to monitor the performance of launch vehicle subsystems and display the data to the astronauts. The abort decision was to be the astronauts' alone. A launch abort simulation study by Chance Vought Corporation, Dallas, Texas, completed in April showed the feasibility and desirability of manually initiated abort.

13

Memo, Robert E. Arnall to Chief, FOD, subj: Gemini Abort Simulation Program, Sept. 11, 1962; FOD Monthly Activity Report, Apr. 30, 1962; Abstract of Meeting on Gemini/Titan Coordination, Apr. 19, 1962; Martin Report MMB LV-14, "MDS Descriptive Study," Apr. 23, 1962; Harris, *Gemini Launch Vehicle Chronology*, p. 7.

NASA announced that applications would be accepted for additional astronauts until June 1, 1962. NASA planned to select five to ten astronauts to augment the seven-member Mercury astronaut team. The new pilots would participate in support operations in Project Mercury and would join the Mercury astronauts in piloting the two-man Gemini spacecraft. To be chosen, the applicant must (1) be an experienced jet test pilot and preferably be presently engaged in

18

1962
April

flying high-performance aircraft; (2) have attained experimental flight test status through military service, aircraft industry, or NASA, or must have graduated from a military test pilot school; (3) have earned a degree in the physical or biological sciences or in engineering; (4) be a United States citizen under 35 years of age at the time of selection, six feet or less in height; and (5) be recommended by his parent organization. Pilots meeting these qualifications would be interviewed in July and given written examinations on their engineering and scientific knowledge. Selected applicants would then be thoroughly examined by a group of medical specialists. The training program for the new astronauts would include work with design and development engineers, simulator flying, centrifuge training, additional scientific training, and flights in high-performance aircraft.

Memo, Holmes to Webb, Dryden, and Seamans, Subj: Selection of Additional Astronauts, Apr. 28, 1962, with enc., "Gemini and Apollo Astronaut Selection"; MSC Space News Roundup, May 2, 1962, p. 1; Astronautical and Aeronautical Events of 1962, p. 56.

19

McDonnell awarded a \$26.6 million subcontract to International Business Machines (IBM) Corporation's Space Guidance Center, Owego, New York, to provide the computer system for the Gemini spacecraft. The digital computer was the heart of the spacecraft's guidance and control system; supplementary equipment consisted of the incremental velocity indicator (which visually displayed changes in spacecraft velocity), the manual data insertion unit (for inserting data into, and displaying readouts from, the computer), and the auxiliary computer power unit (to maintain stable computer input voltages).

Figure 29.—Block diagram of the Gemini spacecraft guidance and control system. (McDonnell, "Project Gemini Familiarization Charts," June 5, 1962, unpagged.)

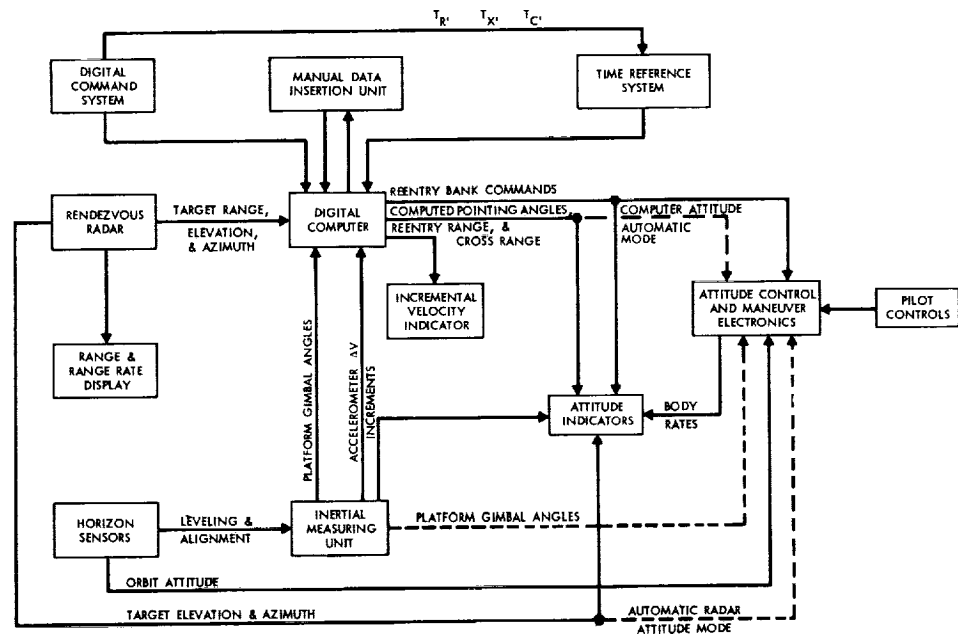

In addition to providing the computer and its associated equipment, IBM was also responsible for integrating the computer with the systems and components it connected with electrically, including the inertial platform, rendezvous radar, time reference system, digital command system, data acquisition system, attitude control and maneuver electronics, the launch vehicle autopilot, console controls and displays, and aerospace ground equipment.

1962
April

Quarterly Status Report No. 1, p. 17; McDonnell Subcontracts (over \$250,000) as of Dec. 31, 1962; McDonnell *Final Report*, pp. 208–211.

Studebaker Corporation's CTL Division, Cincinnati, Ohio, received a subcontract for \$457,875 from McDonnell to provide two backup heatshields for the Gemini spacecraft, similar in material and fabrication technique to those used in Project Mercury. The CTL heatshield would be used only if a new shield McDonnell was working on proved unusable. Test results from screening advanced heatshield materials had yielded four promising materials. McDonnell had contracted with Vidya, Inc., Palo Alto, California (March 16), and Chicago Midway Laboratories, Chicago, Illinois (mid-April), to test the new ablation materials.

25

Quarterly Status Report No. 1, p. 9; Atkinson, "Gemini—Major Subcontracts, McDonnell Aircraft Corporation"; McDonnell Subcontracts (over \$250,000) as of Dec. 31, 1962.

At an Atlas-Agena coordination meeting, Lockheed presented a comprehensive description of its proposed propulsion development plans for the Gemini-Agena. Lockheed's planned program included: propulsion system optimization studies, a multiple-restart development program for the primary propulsion system, and a development program for the secondary propulsion system.

26

Abstract of Atlas-Agena Coordination Meeting, Apr. 28, 1962.

Representatives of North American, NASA Headquarters, Langley Research Center, Flight Research Center, Ames Research Center, and Manned Spacecraft Center met to review the design and testing philosophy for the half-scale test vehicle (HSTV) in phase II-A of the Paraglider Development Program. After the emergency parachute recovery system had been qualified, the HSTV would be used to evaluate paraglider stability and control in drop tests with the wing predeployed and to provide empirical data on the functioning of vehicle systems in deployment tests. At the end of the review, the NASA Half Scale Test Vehicle Design Review Board recommended 21 changes in test vehicle design and test procedures to North American.

26–27

Minutes of Meeting of Paraglider Development Program (Phase II-A) Half Scale Test Vehicle Design Review, May 16, 1962; NAA Report SID65-196, "Final Report of Paraglider Research and Development Program, Contract NAS 9-1484," Feb. 19, 1965, p. 184 (hereafter cited as "Paraglider Final Report").

McDonnell proposed to evaluate the Gemini rendezvous radar and spacecraft maneuvering system on early flights by using a rendezvous evaluation pod to be ejected from the spacecraft in orbit. Manned Spacecraft Center (MSC) liked the idea and asked McDonnell to pursue the study. During the last week in June, McDonnell received approval from MSC to go ahead with the design

May
1

1962
May

and development of the rendezvous pod. It would contain a radar transponder, C-band beacon, flashing light, and batteries.

MSC, Weekly Activity Report for the Office of the Director, Manned Space Flight, June 24-30, 1962, p. 5 (hereafter cited as Weekly Activity Report); Abstract of . . . Coordination Meeting (electrical), May 2, 1962.

1

Air Force Space Systems Division (SSD) awarded a letter contract to Lockheed Missiles and Space Company for eight Agena vehicles to be modified as Gemini Agena target vehicles (GATV). Mission requirements were to (1) establish a circular orbit within specified limits, (2) provide a stable target with which the spacecraft could rendezvous and dock, (3) respond to commands from either ground stations or the spacecraft, (4) perform a complex series of orbital maneuvers by means of either real-time or stored commands if less than optimum launch of Agena or spacecraft occurred, and (5) provide an active orbit life of five days. Lockheed's analysis of these mission requirements provided the design criteria for the major modifications required to adapt the Agena to the Gemini mission: (1) modification of the primary propulsion system; (2) addition of a secondary propulsion system (two 16-pound and two 200-pound thrusters) to provide ullage orientation and minor orbit adjustments; (3) design of a digital command and communications subsystem including a programmer, controller, pulse-code-modulated telemetry system, and onboard tape recorder; (4) design of changes to provide the guidance and control functions peculiar to the GATV; and (5) addition of an auxiliary forward equipment rack with an interface capable of supporting the target docking adapter. On direction from Air Force Systems Command Headquarters, SSD authorized Lockheed to proceed with the Gemini-Agena program on March 19.

Lockheed LMSC-A605200-2 and -7, *Gemini Agena Target Vehicle Program Progress Reports*; October 1964, p. A-1; March 1965, p. A-1 (hereafter cited as *GATV Progress Report*); Aerospace Report TOR-1001(2126-80)-3, *Gemini Program Launch Systems Final Report: Gemini/Titan Launch Vehicle; Gemini/Agena Target Vehicle; Atlas/SLV-3*, January 1967, pp. III. A-1, III. C-1 (hereafter cited as *Aerospace Final Report*).

1

Following a Lockheed briefing on pulse-code-modulation (PCM) instrumentation systems, representatives of Goddard Space Flight Center and Manned Spacecraft Center (MSC) formed a small working group to discuss the feasibility of making the Gemini telemetry system a full PCM system. PCM was a digital telemetry system which could provide more channels of information, faster data rates, improved accuracy, and less weight of equipment per data channel. Goddard had already reviewed several PCM ground station proposals and had concluded that such a system could handle future NASA programs. All who attended the meeting agreed that a full PCM telemetry system, airborne and ground, could be implemented in time to support the Gemini program. Gemini Project Office approved the formation of an MSC-Gemini PCM Instrumentation Working Group to be responsible for the implementation and compatibility of the airborne and ground PCM system for Gemini. On June 27, Walter C. Williams, MSC Associate Director, notified Goddard of NASA's decision "to utilize a PCM telemetry system for Gemini and Agena real time data." Ten sites were selected for the installation of PCM equipment; each of these also received dual acquisition equipment, dual digital command system,

and pulse coders for distinguishing between the manned Gemini spacecraft and the Agena target when both were in orbit.

1962
May

Letter, Williams to N. R. Heller, Subj: Range Modifications for Project Gemini, June 27, 1962; Abstract of . . . PCM Instrumentation Coordination Meeting, May 7, 1962; NASA *Eighth Semiannual Report to Congress, July 1–December 31, 1962*, pp. 131–132.

Manned Spacecraft Center issued its third analysis of the Gemini program schedule. Spacecraft ground test plans had been formulated, and construction of test hardware had begun. Two boilerplate spacecraft had been added to the program to facilitate ground testing. Flight No. 2 was the first planned to use paraglider, but the paraglider program required close attention to prevent schedule slippage; plans to substitute a parachute landing system for paraglider in this flight, should it prove necessary, had been initiated. Spacecraft manufacturing schedules were endangered by late delivery of components from vendors: chief threats to spacecraft No. 1 were components of the instrument and recording system and the inertial platform; for spacecraft No. 2, communication and electrical system components. No problems were anticipated with the booster. The analysis indicated no change in the launch schedule.

4

NASA-MSC, Gemini Project Office, "Project Gemini Schedule Analysis," May 4, 1962.

Gemini Project Office directed McDonnell to determine what would be involved in opening and closing the spacecraft hatches in the space environment and Manned Spacecraft Center's Life Systems Division to determine what special pressure suit features would be required to provide crew members with a 15-minute extravehicular capability.

10-11

Abstract of Meeting on Crew Support Systems, May 14, 1962.

Manned Spacecraft Center's Life Systems Division proposed to measure seven parameters for determining crew condition during all Gemini flights. These were, in order of priority: blood pressure, with electrocardiogram and phonocardiogram serving as first and second backup; electroencephalogram; respiration; galvanic skin response, and body temperature. The bioinstrumentation required would cost about three and one-half pounds per man, with a total power consumption of about two watt-hours and the shared use of six channels of telemetry. Gemini Project Office reviewed these requirements and approved the following measurements: electrocardiogram, respiration rate and depth, oral temperature, blood pressure, phonocardiogram, and nuclear radiation dose. Biomedical measurement devices had still to be designed, developed, qualified, and procured.

10-11

Memo, Chamberlin to Stanley C. White, Subj: Development of Biomedical Instrumentation for Gemini Missions, Aug. 23, 1962; Quarterly Status Report No. 1, pp. 40-41; Abstract of Meeting on Crew Support Systems, May 14, 1962.

The postlanding survival kit proposed for use by Gemini crew members would be basically similar to the one used in Project Mercury. Each kit would weigh about 24 pounds, and one kit would be provided for each crew member.

10-11

Abstract of Meeting on Crew Support Systems, May 14, 1962.

PROJECT GEMINI: A CHRONOLOGY

- 1962
May
11 Manned Spacecraft Center (MSC) decided to establish a liaison office at Martin-Baltimore. Scott H. Simpkinson of Gemini Project Office assumed the post on May 15, but he was soon replaced by Harle Vogel, who remained in the position throughout the program. The purpose of the office was to facilitate exchange of information between MSC and Martin.
- Abstract of . . . Gemini/Titan Coordination Meeting, May 14, 1962; interview, Vogel, Baltimore, May 23, 1966.
- 12 James E. Webb, NASA's new Administrator, reviewed the Gemini program. Project Gemini cost estimates at this point (\$744.3 million) had increased substantially over the original estimate of \$520 million. Estimated spacecraft cost had risen from \$240.5 to \$391.6 million; Titan II cost, from \$113.0 to \$161.8 million; Atlas-Agena, from \$88.0 to \$106.3 million; and supporting development (including the paraglider program), from \$29.0 to \$36.8 million. Estimated operations costs had declined from \$59.0 to \$47.8 million.
- Memo, Holmes to Webb, Subj: Project Gemini Cost Estimates, Apr. 29, 1963, with enc., "Status of Project Gemini Cost Estimates."
- 14-15 Representatives of McDonnell, Northrop Ventura (formerly Radioplane), Weber Aircraft, and Manned Spacecraft Center attended the first ejection seat design review at McDonnell in St. Louis.
- Abstract of Meeting on Ejection Seat Design Review, May 21, 1962.
- 16-17 A Launch Vehicle-Spacecraft Interface Working Group was established. Gemini Project Office (GPO) and Aerospace had agreed on the need for such a group at a Gemini-Titan coordination meeting on May 11. The main function of the group, composed of Martin and McDonnell personnel with a McDonnell representative as chairman, was to provide mutual exchange of design and physical data on mechanical, electrical, and structural details between the spacecraft contractor and the booster contractor. The group would make no policy decisions; its actions were to be reviewed at regularly scheduled coordination meetings held by GPO.
- Abstract of . . . Gemini/Titan Coordination Meeting, May 14, 1962; Abstract of Coordination Meeting on Mechanical Systems, May 19, 1962.
- 16-17 At a mechanical systems coordination meeting, representatives of McDonnell and Gemini Project Office decided to develop more powerful retrograde rocket motors for the Gemini spacecraft. The new motors, similar in configuration to the old but with some three times the thrust level, would permit retrorocket aborts at altitudes as low as 72,000 to 75,000 feet. McDonnell's original subcontract with Thiokol was accordingly terminated and a new subcontract was let on July 20. Development of the new motors was expected to cost \$1.255 million.
- Quarterly Status Report No. 2 for Period Ending Aug. 31, 1962, p. 9; McDonnell Subcontracts (over \$250,000) as of Dec. 31, 1962; Abstract of Coordination Meeting on Mechanical Systems, May 19, 1962.
- 18 McDonnell subcontracted the parachute landing system for Gemini to Northrop Ventura at an estimated cost of \$1,829,272. The parachute landing system was to be used for the first Gemini flight. Gemini Project Office had decided in April on using a single-chute system, one 84.2-foot diameter ring-sail parachute.

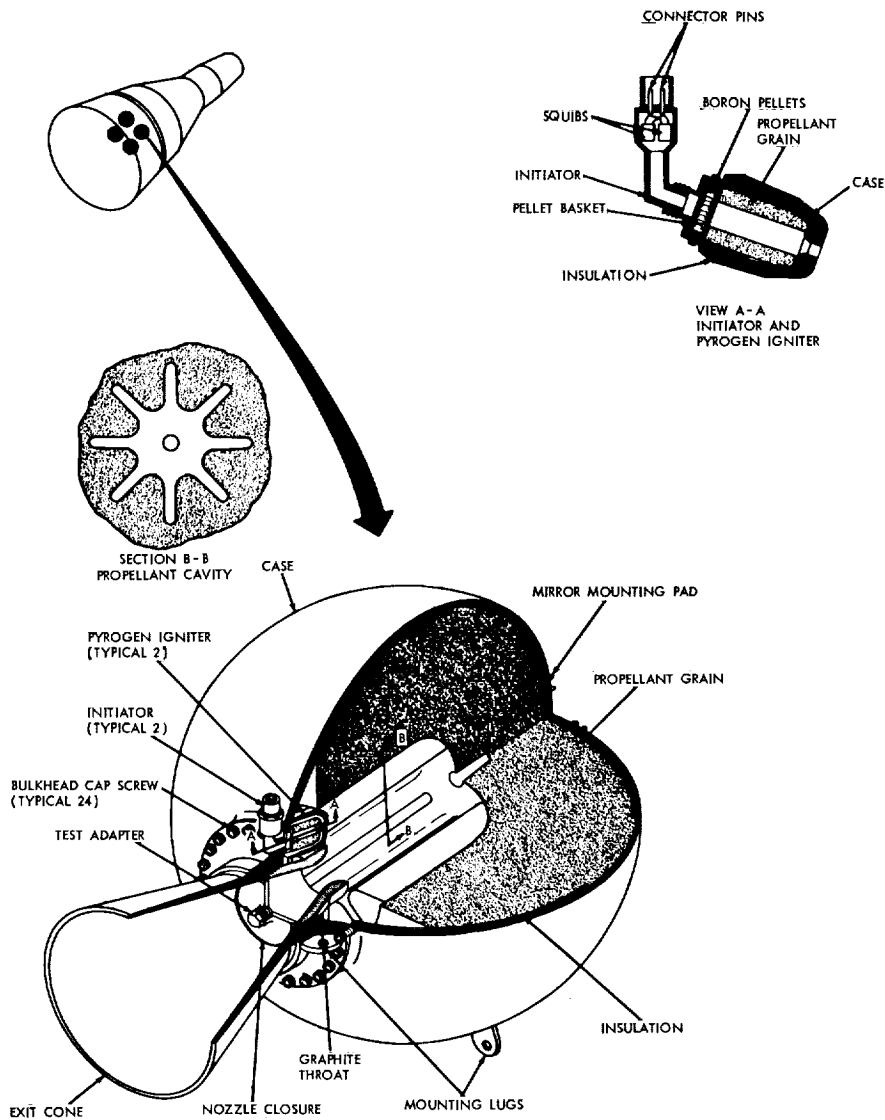

Figure 30.—The solid-propellant retrograde rocket motor for the Gemini spacecraft. (McDonnell, "Project Gemini Familiarization Manual: Manned Spacecraft Rendezvous Configuration," SEDR 300, June 1, 1962, p. 11-30.)

At a mechanical systems coordination meeting in Houston on May 16-17, however, it was decided to add an 18-foot diameter ring-sail drogue parachute to the system. McDonnell proposed deploying the drogue at 10,000 feet, two seconds after release of the rendezvous and recovery system. Fifteen seconds later the main recovery parachute would switch from single-point to two-point suspension, followed in five seconds by the initiation of reaction control system propellant dump which would take no longer than 105 seconds. The recovery parachute would be jettisoned shortly after impact. At another coordination meeting on May 23-24, Manned Spacecraft Center concurred in this proposed sequencing.

1962
May

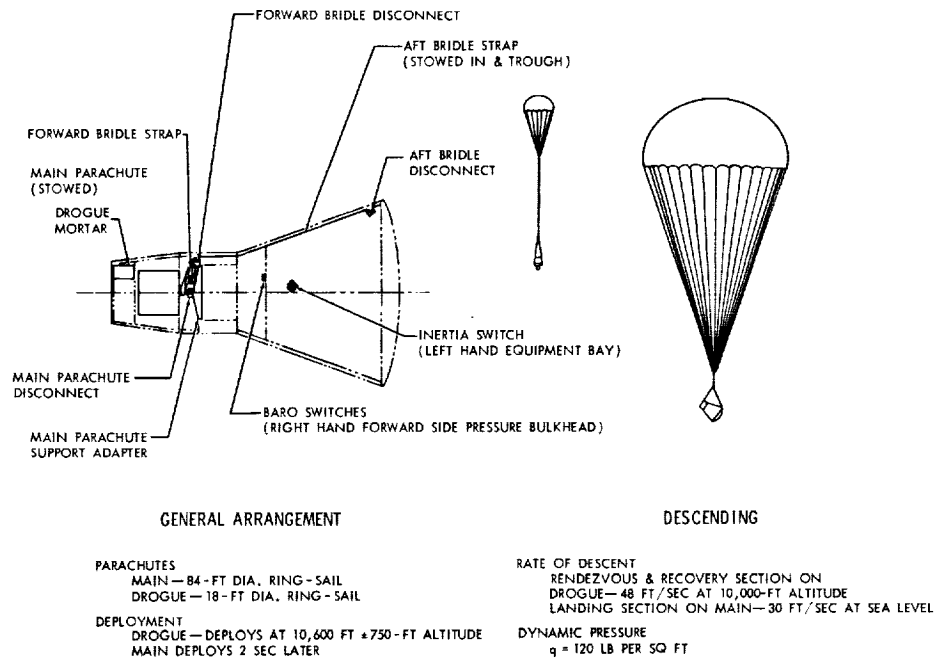

Figure 31.—The parachute recovery system to be used instead of paraglider on the first Gemini spacecraft: stowed and deployed modes. (McDonnell, "Project Gemini Engineering Mockup Review," Aug. 15-16, 1962, p. 39.)

1962
 May

GPO Monthly Activity Report, Apr. 30, 1962; McDonnell Subcontracts (over \$250,000) as of Dec. 31, 1962; Abstracts of Coordination Meetings on Mechanical Systems, May 19 and 25, 1962.

21 McDonnell awarded an \$8 million subcontract to Electro-Mechanical Research, Inc., Sarasota, Florida, to provide the data transmission system for the Gemini spacecraft. Both the spacecraft and target vehicle used pulse-code-modulation (PCM) telemetry, a technique for encoding data in digital form by varying the length of pulses to form an information-carrying code. Once encoded, measurements were transmitted over a radio link to ground receiving stations. The data transmission system consisted of a PCM subsystem, an onboard tape recorder, and two VHF transmitters; it was capable of transmitting data in real time or delayed time.

Quarterly Status Report No. 1, p. 27; McDonnell Subcontracts (over \$250,000) as of Dec. 31, 1962; McDonnell Final Report, pp. 186-187.

21 Amendment No. 6 to the Gemini launch vehicle procurement contract assigned \$2.609 million to fund the construction necessary to convert pad 19 at Cape Canaveral for Gemini flights. The Air Force had originally constructed pad 19 for the Titan I development program. Following the final Titan I development flight (January 29) from the Cape, design of the required modifications had begun in February. In April, Gemini Project Office decided that pad 19 would have an erector rather than a gantry, the upper third of which would be designed as a white room. The final design review of pad 19 modifications took

place July 9–10, and the Army Corps of Engineers awarded the construction contract to Consolidated Steel, Cocoa Beach, Florida. Construction began in September. Work was completed and pad 19 was activated on October 17, 1963.

1962
May

Quarterly Status Reports: No. 2, p. 27; No. 3 for Period Ending Nov. 30, 1962, p. 33; GPO Monthly Activity Report, Apr. 30, 1962; MSC Fact Sheet No. 258, "Gemini Launch Complex 19, Cape Kennedy, Florida," May 1964; Martin, *Gemini-Titan II Air Force Launch Vehicle*, Press Handbook (second ed., 1965, revised Oct. 24, 1966), p. 7–2; Harris, *Gemini Launch Vehicle Chronology*, pp. 29, A–1.

Representatives of McDonnell and Manned Spacecraft Center completed a series of 24 meetings to negotiate the technical details of McDonnell's plans for supporting and documenting Project Gemini, specifications for Gemini systems and subsystems, environmental and structural design criteria for the spacecraft, spacecraft performance specifications, test programs, and plans for reliability, quality assurance, and validation. Meetings had begun April 19.

23

Abstracts of Technical Negotiation Meetings on: Simulators and Trainers, Apr. 24, 1962; Support Plan, MAC Report 8580–4 (Feb. 2, 1962), May 2; Associate Contractor Coordination, Engineering Inspections and Incorporation of Government Furnished Equipment, May 16; Gemini Facility Plans, MAC Report 8580–2 (Mar. 15, 1962), May 4; Documentation Plan, MAC Report 8580–8 (Jan. 29, 1962), May 4; Post Landing and Survival System, Apr. 27; Programmer/Timer (Time Reference), May 1; Environmental Control Subsystem, Apr. 27; Propulsion Systems, May 1; Environmental Criteria, May 1; Pyrotechnics System Specification, May 4; Electrical System Specification, May 3; Guidance and Control System Specification, May 9; Structural Design Criteria, May 1; Landing System, May 11; Gemini Spacecraft Performance Specification, May 5; Program Progress Report, May 8; Test Program, May 21; Reliability Plan, MAC Report 8580–3 (Feb. 5, 1962), May 11; Quality Assurance Plan, MAC Report 8580–7 (Jan. 22, 1962), May 11; Publication Plan of Support Plan, MAC Report 8580–4 (Feb. 2, 1962), May 16; Validation Testing, May 23, 1962.

Ames Research Center began the first wind tunnel test of the half-scale inflatable paraglider wing in support of the Paraglider Development Program. This was the first test of a large-scale inflatable paraglider wing in the full-scale test facility. Purpose of the test was to obtain basic aerodynamic and loads data for the combined wing/spacecraft system and to spot and evaluate potential aerodynamic and design problem areas. The flight regimes studied included wing deployment as well as glide, preflare, and flare. In the last stages of the test, the sail ripped. Since the basic objectives had already been achieved, and the failure occurred under conditions more stringent than any expected during flight testing, only minor corrective action was considered necessary and the test was not repeated. Testing ended July 25; at a paraglider landing system coordination meeting on July 26, the Ames test program was considered completed.

23

Quarterly Status Report No. 2, p. 11; Abstract of Meeting on Mechanical Systems, May 25, 1962; Abstract of Meeting on Paraglider Landing System, Aug. 1, 1962; "Paraglider Final Report," pp. 152–155.

Manned Spacecraft Center concurred in McDonnell's proposed sequencing of the paraglider recovery system. In a normal mission, the drogue parachute (a small parachute to pull the recovery compartment away from the spacecraft and strip the paraglider from the recovery compartment) would deploy at 60,000 feet, followed by the release of the rendezvous and recovery section at 50,000 feet. Starting at 10,000 feet, all reaction control system propellant re-

23–24

PROJECT GEMINI: A CHRONOLOGY

1962
May

maining after the paraglider had been deployed would be dumped. The paraglider wing itself would be jettisoned shortly after touchdown. At this point, plans called for the paraglider to be used on all Gemini missions except the first.

Abstracts of Meetings on Mechanical Systems, May 19 and 25, 1962; Abstract of Meeting on Spacecraft-Paraglider Interface, Mar. 2, 1962.

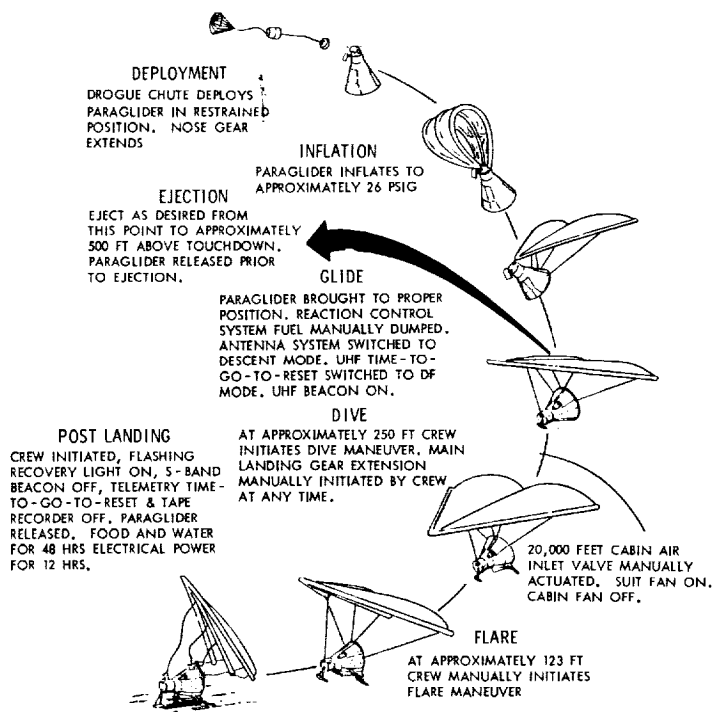

Figure 32.—The proposed sequence of events in deploying the paraglider to land the Gemini spacecraft. (McDonnell, "Project Gemini Familiarization Manual: Manned Spacecraft Rendezvous Configuration," SEDR 300, June 1, 1962, p. 12-8.)

24

North American began a test program to qualify the emergency parachute system for the half-scale flight test vehicle required for Phase II-A of the Paraglider Development Program. The first two drop tests were successful (May 24, June 20); but during the third (July 10), the main recovery parachute failed to deploy. The trouble was analyzed and detailed modifications were worked out at a meeting on August 16 between North American and Northrop Ventura. The modifications proved successful in the fourth test (September 4), and Manned Spacecraft Center concurred with North American in judging the emergency parachute system for the half-scale test program to be qualified.

Quarterly Status Reports: No. 2, p. 13; No. 3, p. 13; NAA Monthly progress Letters on Phase II-A: No. 7, July 5; No. 8, Aug. 1; No. 9, Sept. 1; No. 10, Nov. 26, 1962.

29

Representatives of McDonnell, Weber Aircraft, Gemini Procurement Office, Life Systems Division, Gemini Project Office, and U.S. Naval Ordnance Test Station, China Lake, California, concluded plans for development testing of

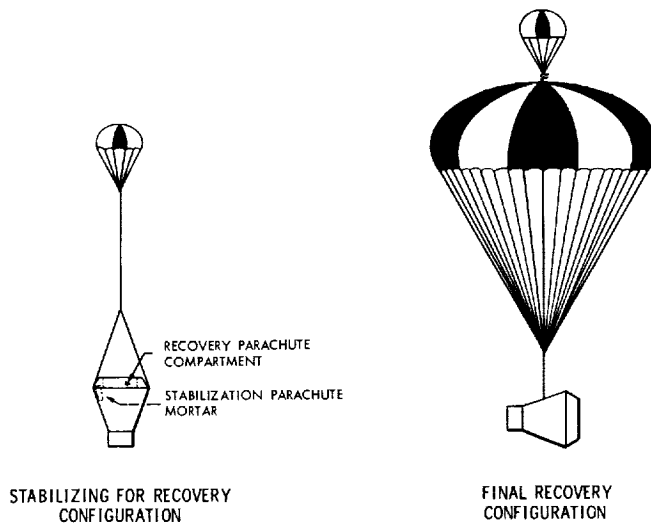

Figure 33.—The emergency parachute recovery system for the half-scale paraglider flight test vehicle for Phase II-A of the development program. (North American Aviation, Inc., Space and Information Systems Division, Paraglider Projects, "Midterm Progress Report, Paraglider Development Program, Phase II, Part A, System Research and Development," SID 62-391, Apr. 20, 1962, p. 228.)

the spacecraft ejection seat. Requirements peculiar to the Gemini spacecraft, in particular off-the-pad abort capability, caused the plan to stress testing from a stationary tower early in the test program. The purpose of these simulated off-the-pad ejection tests was to investigate the effects of varying the center of gravity on the trajectory of the ejected seat and to optimize the timing of the recovery sequence. Tower tests began July 2. They were to be followed by rocket sled ejection tests to investigate simultaneous ejection with open hatches at maximum dynamic pressure. Sled tests actually began on November 9, before tower tests had been completed.

1962
May

Quarterly Status Report No. 1, p. 21; Abstract of Meeting on Ejection Seat Developmental Test Program, June 4, 1962.

A list of the aerospace ground equipment required to handle and check out the Gemini spacecraft before flight was presented at the first spacecraft operations coordination meeting.

June
1

Abstract of Meeting on Spacecraft Operations, June 5, 1962.

The Air Force School of Aviation Medicine, Brooks Air Force Base, Texas, began a simulated long-duration Gemini mission. Two men were to live for 14 days in a 100-percent-oxygen atmosphere maintained at a pressure of 5 pounds per square inch, the proposed spacecraft environment.

4

NASA-Defense Purchase Request T-8630-G, June 25, 1962; Life Systems Division Weekly Activity Report, June 8, 1962.

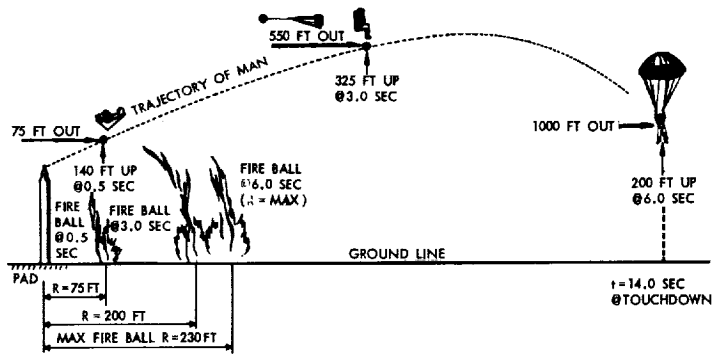

Figure 34.—The "off-the-pad" escape mode for an aborted Gemini mission. (Charts presented by K. Hecht, "Project Gemini Familiarization Briefing," July 9-10, 1962, unpagged.)

1962
June
6

McDonnell was authorized to procure an additional boilerplate spacecraft for parachute landing system tests. The original plan called for McDonnell to use the boilerplate spacecraft fabricated by North American for qualification testing of the emergency parachute system for the paraglider drop tests. McDonnell estimated, however, that modifying the North American boilerplate would cost from \$17,000 to \$19,000, whereas a new boilerplate would cost from \$10,000 to \$12,000.

Abstract of Meeting on Mechanical Systems, June 8, 1962.

6

Whirlpool Corporation Research Laboratories, St. Joseph, Michigan, received a contract from Manned Spacecraft Center (MSC) to provide the Project Gemini food and waste management system, comprising water dispenser, food storage, and waste storage components. Food and zero-gravity feeding devices were to be provided by the U.S. Army Quartermaster Corps Food and Container Institute, Chicago, Illinois. MSC's Life Systems Division was responsible for directing the development program.

Quarterly Status Report No. 1, p. 16; GPO Activity Report, May 28, 1962, pp. 6-7; letter, William D. Fowler, Whirlpool Corp., to E. L. Michel, MSC-LSD, Subj: GEMINI Feeding and Waste System—NAS 9-557, Oct. 2, 1962.

20

Manned Spacecraft Center authorized North American to go ahead with Phase II, Part B(1), of the Paraglider Development Program. Letter contract NAS 9-539 followed. Under this contract, North American was to design, build, and test an advanced two-man paraglider trainer, to initiate a flight simulation program for pilot training, and to complete the design of a man-rated Gemini paraglider wing. The final contract was awarded on October 31, 1962.

Weekly Activity Report, June 24-30, 1962, p. 5; NAA letters, Subj: Contract NAS 9-539, Paraglider Development Program, Phase II, Part B(1), Monthly Progress Letter No. 1, Aug. 8, 1962; Supplemental Proposal, Contracts NAS 9-167 and NAS 9-539, Paraglider Phase II A and Phase II B(1), June 11, 1963, p. 1.

21-22

A paraglider full-scale test vehicle Design Engineering Inspection was held at North American's Space and Information Systems Division in Downey, California. The Manned Spacecraft Center inspecting team reviewed the design of

the full-scale paraglider wing, capsule, and associated equipment, as well as the test program and schedules for Phase II-A of the Paraglider Development Program. The team suggested 33 changes, mostly related to hardware.

1962
June

Quarterly Status Report No. 2, p. 13; NAA Monthly Progress Letter on Phase II-A, No. 8, Aug. 1, 1962.

Gemini Project Office reported that a thorough study of the reentry tracking histories of the Mercury-Atlas 4, 5, 6, and 7 missions had been completed. The study indicated that a C-band radar tracking beacon should be integrated into the spacecraft reentry section in place of the planned S-band beacon. The change would improve the probability of tracking spacecraft reentry through the ionization zone.

25

GPO Monthly Activities Report, June 25, 1962.

After considering Gemini-related investigations that might be carried out with the help of Mercury, Gemini Project Office and McDonnell decided that the most useful would be testing heatshield materials and afterbody-shingle characteristics. Samples of the Gemini heatshield were later flown satisfactorily on the Mercury-Atlas 8 *Sigma 7* mission.

27-28

Weekly Activity Report, June 24-30, 1962, p. 6; Quarterly Status Report No. 3, p. 7; Abstract of Meeting on Mechanical Systems, June 29, 1962.

McDonnell and North American representatives met for the first time to exchange detailed technical information on the installation of the paraglider in the spacecraft.

28

Weekly Activity Report, June 24-30, 1962, p. 5; Minutes of Paraglider Installation Meeting, June 28, 1962.

Martin-Baltimore's airborne systems functional test stand went into operation at Baltimore. In this 3000-square-foot facility, all airborne systems in the Gemini launch vehicle—including flight control, hydraulic, electrical, instrumentation, and malfunction detection—were assembled on tables and benches; actual engines, but simulated propellant tanks and guidance, were used. In addition to individual and combined systems tests, the facility was used to check system design changes and to trouble-shoot problems encountered in other test programs.

30

Gemini-Titan II Air Force Launch Vehicle, pp. 4-1, 4-5.

Simulated off-the-pad ejection tests began at Naval Ordnance Test Station. Five ejections were completed by the first week of August. The tests revealed difficulties which led to two important design changes: the incorporation of a drogue-gun method of deploying the personnel parachute and the installation of a three-point restraint-harness-release system similar to those used in military aircraft. August 6-7 representatives of Manned Spacecraft Center and ejection system contractors met to review the status of ejection seat design and the development test program. They decided that off-the-pad ejection tests would not be resumed until ejection seat hardware reflected all major anticipated design features and the personnel parachute had been fully tested. Design changes were checked out in a series of bench and ground firings, concluding on August

July
2



Figure 35.—Airborne systems functional test stand at Martin's Baltimore plant. (Martin, Gemini-Titan II Air Force Launch Vehicle, *Press Handbook*, Feb. 2, 1967, p. 4-3.)

1962
July

30 with a successful inflight drop test of a seat and dummy. Off-the-pad testing resumed in September.

Quarterly Status Report No. 2, p. 17; Abstract of Meeting on Ejection Seats, Aug. 9, 1962.

3

Gemini Project Office met with representatives of Manned Spacecraft Center's Flight Operations Divisions, McDonnell, International Business Machines, Aerospace, Air Force Space Systems Division, Lockheed, Martin, Space Technology Laboratories, Inc. (Redondo Beach, California), and Marshall Space Flight Center to outline the work to be done before final mission planning. A center coordinating group, with two representatives from each agency, was established.

Memo, James F. Dalby to Acting Chief, FOD, Subj: Coordination of Effort of Contractors Performing Guidance and Trajectory Studies for Project Gemini, July 3, 1962.

6

Martin prepared a plan for flight testing the malfunction detection system (MDS) for the Gemini launch vehicle on development flights of the Titan II weapon system. Gemini Project Office (GPO) had requested Martin to prepare such a plan at the Gemini design review of April 10-11, 1962. Air Force Space Systems Division and Aerospace approved the plan and won GPO concurrence early in August. This so-called "piggyback plan" required installing the Gemini MDS in Titan II engines on six Titan II flights to demonstrate its reliability before it was flown on Gemini.

Harris, *Gemini Launch Vehicle Chronology*, pp. 10, 11.

The capability for successfully accomplishing water landings with either the parachute landing system or the paraglider landing system was established as a firm requirement for the Gemini spacecraft. The spacecraft would be required to provide for the safety of the crew and to be seaworthy during a water landing and a 36-hour postlanding period.

1962
July
11

Abstracts of Meetings on Mechanical Systems, July 14, Aug. 7, 1962.

Representatives of Gemini Project Office (GPO), Flight Operations Division, Air Force Space System Division, Marshall Space Flight Center, and Lockheed attended an Atlas-Agena coordination meeting in Houston. GPO presented a list of minimum basic maneuvers of the Agena to be commanded from both the Gemini spacecraft and ground command stations. GPO also distributed a statement of preliminary Atlas-Agena basic mission objectives and requirements. A total of 10 months would be required to complete construction and electrical equipment checkout to modify pad 14 for the Atlas-Agena, beginning immediately after the last Mercury flight.

12

Memo, James A. Ferrando to Chief, FOD, Subj: Information Gathered at Atlas-Agena Coordination Meeting of July 12, 1962, July 17, 1962; Abstract of Meeting on Atlas-Agena, July 14, 1962.

A technical team at the Air Force Missile Test Center, Cape Canaveral, Florida—responsible for detailed launch planning, consistency of arrangements with objectives, and coordination—met for the first time with official status and a new name. The group of representatives from all organizations supplying major support to the Gemini-Titan launch operations, formerly called the Gemini Operations Support Committee, was now called the Gemini-Titan Launch Operations Committee.

12

Minutes of Meeting of Gemini-Titan Launch Operations Committee (GTLOC), July 13, 1962; memo, George E. Mueller to Webb, Subj: Development of the Gemini Launch Vehicle, with enc., "The Gemini Launch Vehicle," Dec. 6, 1965, p. 1.

To ensure mechanical and electrical compatibility between the Gemini spacecraft and the Gemini-Agena target vehicle, Gemini Project Office established an interface working group composed of representatives from Lockheed, McDonnell, Air Force Space Systems Division, Marshall, and Manned Spacecraft Center. The group's main function was to smooth the flow of data on design and physical details between the spacecraft and target vehicle contractors.

13

Message, Chamberlin to Marshall *et al.*, Subj: Establishment of a Target Vehicle/Spacecraft Interface Working Group, July 13, 1962.

Gemini Project Office and North American agreed on guidelines for the design of the advanced paraglider trainer, the paraglider system to be used with static test article No. 2, and the paraglider system for the Gemini spacecraft. The most important of these guidelines was that redundancy would be provided for all critical operations.

19

Abstract of Meeting on Paraglider Landing System, July 21, 1962.

NASA Administrator James E. Webb announced officially that a new mission control center for manned space flight would be established at Manned Spacecraft Center (MSC) in Houston. Project Mercury flights were controlled from

20

PROJECT GEMINI: A CHRONOLOGY

1962
July

the center at Cape Canaveral, but these facilities were inadequate for the more complex missions envisioned for the Gemini and Apollo programs. Philco Corporation's Western Development Laboratories, Palo Alto, California, had received a contract in April 1962 to study a design concept for the flight information and control functions of the mission control center. The U.S. Army Corps of Engineers would supervise construction of this center as it had all major facilities at MSC. The control center was expected to be operational in 1964 for Gemini rendezvous flights and to cost about \$30 million.

NASA Press Release No. 62-172, July 20, 1962.

25

McDonnell reported reducing the rated thrust of the two forward-firing thrusters from 100 pounds to 85 pounds to reduce disturbance torques generated in the event of maneuvers with one engine out.

Quarterly Status Report No. 3, p. 15; McDonnell, "Project Gemini Monthly Progress Letter Report, 26 June 1962 thru 25 July 1962," undated, p. 17.

25-26

A reliability review of the Titan II launch vehicle engine system was held in Sacramento, California, at Aerojet-General's Liquid Rocket Plant, the site where the engines were being developed. Gemini engines had to be more reliable than did intercontinental ballistic missile (ICBM) engines. This requirement meant supplementing the ICBM engine reliability program, a task being performed by Aerojet under Air Force Space Systems Division direction.

Quarterly Status Report No. 2, p. 26.

August
2

Lockheed presented study findings and design recommendations on the Agena D propulsion systems to representatives of Marshall, Manned Spacecraft Cen-

Figure 36.—The emergency parachute recovery system for the full-scale paraglider flight test vehicle. (North American Aviation, Inc., Space and Information Systems Division, Paraglider Projects, "Midterm Progress Report, Paraglider Development Program, Phase II, Part A, System Research and Development," SID 62-391, Apr. 20, 1962.)

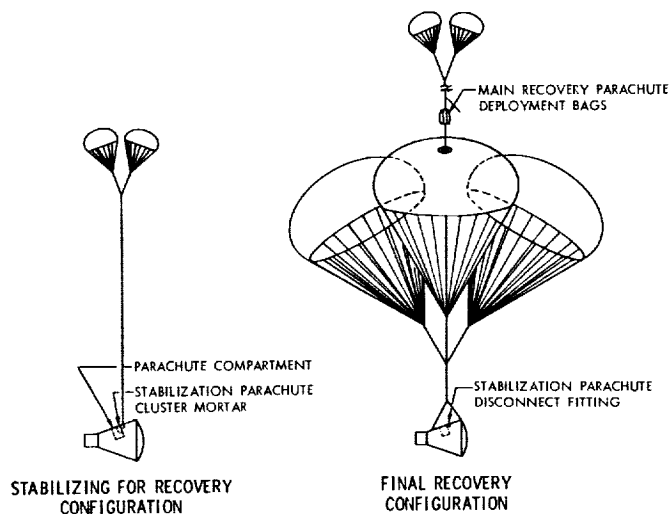

1962
August

ter, and Air Force Space Systems Division in a meeting at Houston. During July, NASA and the Air Force had tentatively decided to substitute the Agena D for the Agena B in the Gemini program. Lockheed's presentation at Houston was the final report on the analysis phase of the Gemini-Agena effort. It included Lockheed's evaluation of the designs of both the primary and secondary propulsion systems and its analysis of tests on the start system of the multiple-restart main engine recently completed by Bell Aerosystems Company, Buffalo, New York, the engine subcontractor. A pressurized-start tank system was selected in September.

Quarterly Status Reports: No. 2, pp. 25-26; No. 3, p. 31; Lockheed Report LMSC-447186-26, *Medium Space Vehicles Programs Monthly Progress Report, August 1962*, Sept. 20, 1962, pp. 9-10 (hereafter cited as *Lockheed Agena Monthly Report*); Lockheed, LMSC-A766871, *Gemini Agena Target Press Handbook*, Feb. 15, 1966, p. 3-1.

North American began a test program to qualify the emergency parachute recovery system for the full-scale test vehicle in Phase II-A of the Paraglider Development Program. The first test was successful. In the second test (August 22), one of the three main parachutes was lost after deployment, but no damage resulted. In the third test (September 7), only minor damage was sustained despite the loss of two parachutes. The test series ended on November 15 when all recovery parachutes separated from the spacecraft immediately after deployment and the test vehicle was destroyed on impact. Manned Spacecraft Center decided to terminate this portion of the test program but directed McDonnell to supply North American with a boilerplate spacecraft for further tests at a later date.

2

Quarterly Status Reports: No. 2, p. 13; No. 3, p. 13; NAA Monthly Progress Letters on Phase II-A: No. 9, Sept. 1; No. 10, Nov. 26; No. 12, Dec. 31, 1962.

At a meeting in Los Angeles, the Air Force described to Gemini Project Office its plans for converting complex 14 at Atlantic Missile Range, Cape Canaveral, Florida. Complex 14, the site of Mercury launches, would be modified for Project Gemini operations as the target vehicle launch site. The Air Force accepted the responsibility for funding, designing, modifying, and equipping the complex to an Atlas-Agena configuration. This action was scheduled as follows: preliminary design criteria by September 1 and final design criteria by October 1, 1962. Mercury Project Office reported that complex 14 would be available for Gemini on September 1, 1963.

3

Quarterly Status Report No. 2, p. 27.

Flight Control Operations Branch of Manned Spacecraft Center's Flight Operations Division outlined a program of training for Gemini flight controllers. This program included: (1) contractor in-plant training, a one-month course of instruction at McDonnell through which would cycle three classes of 10-15 persons and which would include three weeks of detailed systems training, one week of hardware training, and McDonnell drawing-standard familiarization; (2) individual training of flight controllers in systems and network operations, systems updating, and practical exercises; (3) team training, to include site training, for supporting personnel teams, command site teams, and remote site teams; and (4) network training in the control, communications, and deci-

9

1962
August

sion-making aspects of the network flight control organization, and in detailed checkout of operational procedures, countdowns, systems tests, and network equipment. Because of experience in the earlier program, Mercury flight controllers would be assigned as flight controllers for Project Gemini, although their numbers would be augmented to meet the increased demands of the advanced program.

Memos: Eugene F. Kranz to Chief, FOD, Subj: Personnel Training Plan and Requirements for Project Gemini, Aug. 9, 1962; Christopher C. Kraft, Jr., to Manager, GPO, Subj: Flight Controller Support for Project Gemini, Aug. 20, 1962.

14

North American began flight tests of the half-scale test vehicle (HSTV) in Phase II-A of the Paraglider Development Program two months behind schedule. The instrumented HSTV with the paraglider predeployed was towed aloft by helicopter. Objectives of the predeployed flights were to evaluate flight performance, longitudinal and lateral control characteristics, effectiveness of control, and the flare maneuver capability of the paraglider. Despite various minor malfunctions in all five test flights (August 14, 17, 23, September 17, and October 23, 1962), test results verified the stability of the wing/vehicle combination in free flight and the adequacy of control effectiveness.

Quarterly Status Reports: No. 2, pp. 11-12; No. 3, p. 11; NAA Monthly Progress Letters on Phase II-A: No. 9, Sept. 1; No. 10, Nov. 26; No. 12, Dec. 31, 1962; "Paraglider Final Report," pp. 184-188.

15-16

Manned Spacecraft Center (MSC) formally reviewed McDonnell's engineering mock-up of the Gemini spacecraft in St. Louis. The company had begun building the mock-up in January, shortly after receiving the spacecraft contract. Mock-up review had originally been scheduled for mid-July, but informal examinations by MSC representatives, including James A. Chamberlin and several astronauts, had produced some suggested changes. The review itself resulted in McDonnell's receiving 167 requests for alterations. MSC inspected the revised mock-up in November.

Memo, James W. Bilodeau to Project Gemini, Subj: Evaluation of Gemini Mockup, July 2, 1962; MSC Minutes of Senior Staff Meeting, July 6, 1962, p. 6; Quarterly Status Reports: No. 2, pp. 3-5; No. 3, p. 3; "Project Gemini Mock-up Review, Aug. 15-16, 1962," Aug. 28, 1962; McDonnell Report 9031, "Project Gemini Engineering Mockup Review," Aug. 15-16, 1962; Lindley interview.

16

The Air Force and NASA agreed to use a standard Atlas space booster for the Gemini program, sharing the development cost equally. Ground rules for the standard Atlas space booster (which was then being developed by the Air Force) were (1) no new development program, (2) rearranging equipment in the pad for standardization, (3) eliminating splices, (4) combining electrical installations, (5) minimizing differences between programs, and (6) incorporating known reliability improvements. Conversion of the Atlas intercontinental ballistic missile to the Atlas space booster would require (1) a fully-qualified engine up-rated from 150,000 to 165,000 pounds of thrust, (2) elimination of vernier rockets to lower use of propellants, (3) standard tank pressures, (4) standard pneumatic pressures, (5) elimination of retrorockets, and (6) standard range safety package. The first standard vehicle was expected to be available in September 1963.

Abstract of Meeting on Atlas/Agena, Aug. 22, 1962.

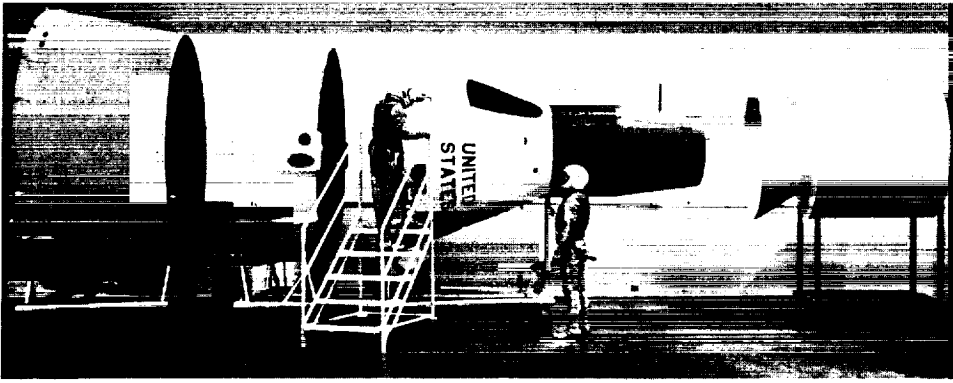

Figure 37.—Two McDonnell technicians examine the engineering mock-up of the Gemini spacecraft, exhibited to 140 industry and NASA representatives in St. Louis on August 15–16, 1962. (McDonnell Photo D4E-257884, no date.)

The Agena status displays were reviewed and eight were approved. These displays comprised seven green lights which, when on, indicated that various functions of the Agena were satisfactory. The eighth, a red light, would go on to indicate main engine malfunction. Gemini Project Office also approved the list of commands required to control certain Agena functions during rendezvous and docking maneuvers by the Gemini spacecraft. The primary mode of command transmittal was expected to be by radio. The Gemini commands to Agena were reviewed on September 13–14, resulting in a list of 34 minimum commands to be initiated from the spacecraft during the Gemini rendezvous maneuver.

1962
August
16

Abstracts of Meetings on Atlas-Agena, Aug. 16, Sept. 24, 1962.

Gemini Project Office initiated a program to coordinate and integrate work on developing Gemini rendezvous and long-duration missions. This program was handled by a mission-planning and guidance-analysis coordination group, assisted by three working panels.

27

GPO Activity Report, Aug. 27, 1962.

At a spacecraft production evaluation meeting, Gemini Project Office and McDonnell revised the projected launch date of the first Gemini flight from August to September 1963. Delays in the delivery of components from vendors caused the revision. The first manned flight (second Gemini mission), however, was still scheduled for November.

28

Abstract of Coordination Meeting on Production Evaluation, Aug. 31, 1962.

Gemini Project Office outlined plans for checking out the Gemini spacecraft at Cape Canaveral. Gemini preflight checkout would follow the pattern established for Mercury, a series of end-to-end functional tests to check the spacecraft and its systems completely, beginning with independent modular systems tests. The spacecraft would then be remated for a series of integrated tests culminating in a simulated flight just before it was transferred to the launch complex. To implement the checkout of the Gemini spacecraft, the Hangar S complex at Cape Canaveral would be enlarged. Major test stations would be housed in

31

1962
August

Hangar AF, an existing facility adjacent to Hangar S. The required facilities were scheduled to be completed by March 1, 1963, in time to support the check-out of Gemini spacecraft No. 1, which was due to arrive at the Cape by the end of April 1963.

Quarterly Status Report No. 2, pp. 35-36; Abstracts of Meetings on Spacecraft Operations, Aug. 13 and 29, 1962.

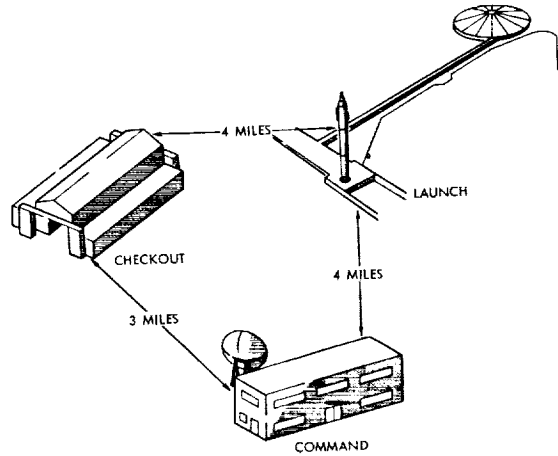

Figure 38.—Proposed layout of Gemini facilities at Cape Canaveral. (McDonnell, "Project Gemini Engineering Mockup Review," Aug. 15-16, 1962, p. 165.)

During
the
month

Rocketdyne completed designing and fabricating prototype hardware for both spacecraft liquid propulsion systems and initiated testing of the reaction control system. Test firing of the 25-pound-thrust chambers revealed nozzle erosion causing degradation in performance after one third the specified burn time.

Quarterly Status Report No. 2, pp. 16-17; Rocketdyne mimeo, "Gemini Propulsion by Rocketdyne—A Chronology," May 15, 1967, p. 9.

September
1

George W. Jeffs became Program Manager of the Paraglider Development Program at North American. He replaced N. F. Witte, who remained as Assistant Program Manager. This organizational change reflected the elevation of work on paraglider from project to program status within North American's Space and Information Systems Division. The paraglider program achieved operating division status three months later when Jeffs was appointed Vice President of Space and Information Systems Division.

NAA Monthly Progress Letters on Phase II-A: No. 9, Sept. 15, 1962; No. 13, Jan. 18, 1963.

4

Gemini Project Office directed McDonnell to provide spacecraft No. 3 with rendezvous radar capability and to provide a rendezvous evaluation pod as a requirement for missions 2 and 3. Four pods were required: one prototype, two flight articles, and one flight spare.

Abstract of Coordination Meeting on Electrical Systems, Sept. 7, 1962.

5

For Gemini rendezvous missions, Manned Spacecraft Center intended to launch the Agena target vehicle first. If conditions were normal, the spacecraft would be launched the following day.

Abstract of Meeting on Trajectories and Orbits, Sept. 26, 1962.

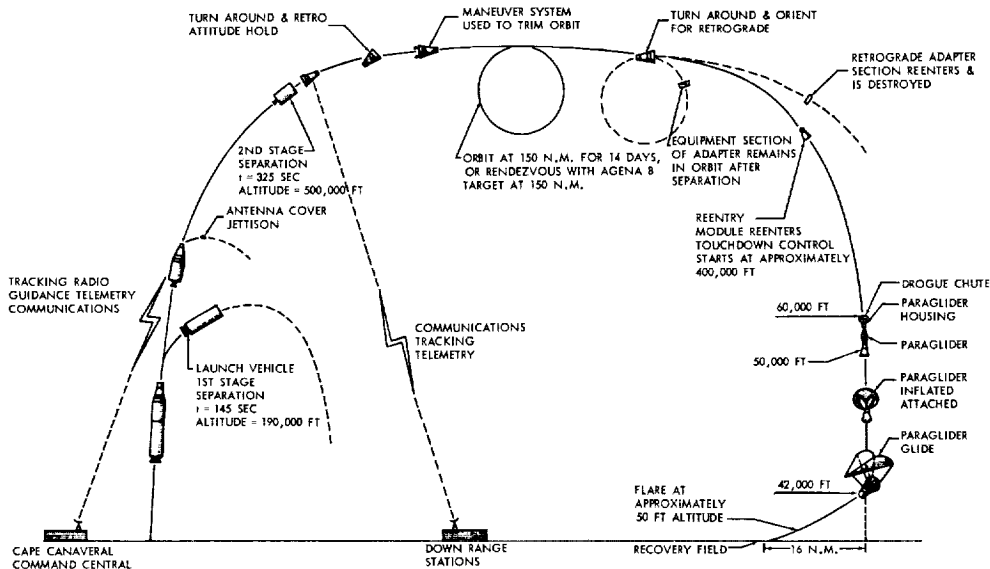

Figure 39.—Planned sequence of events for a Gemini mission. (McDonnell, "Project Gemini Engineering Mockup Review," Aug. 15-16, 1962, p. 23.)

A study group formed at the Gemini mock-up review of August 15-16 met to review the ejection seat development program. McDonnell reported the successful completion of redesign and testing which cleared the way for resumption of off-the-pad developmental testing. McDonnell described the major outstanding design task as the determination of the dynamic center of gravity of the seat-man combination under expected acceleration profiles.

Abstract of Meeting on Ejection Seats, Sept. 11, 1962.

Simulated off-the-pad tests of the redesigned Gemini escape system resumed with test No. 6. Test No. 7 followed on September 20. Though primarily successful, these tests revealed some problems. The seat-structure thrust pad required reanalysis and redesign. Simulated off-the-pad testing was temporarily halted until a final configuration rocket catapult became available. A rocket motor test on January 4, 1963, demonstrated the structural integrity of the thrust-pad area, and simulated pad ejection tests resumed the following month.

Quarterly Status Reports: No. 3, p. 18; No. 4 for Period Ending Feb. 28, 1963, p. 18; Abstracts of Meetings on Ejection Seats, Sept. 20, Oct. 3, 1962.

A coordination meeting on mission planning and guidance defined the first Gemini mission as a spacecraft maximum-heating-rate test. As many spacecraft systems as possible were to be tested, to allow the second flight to be manned. A meeting between Manned Spacecraft Center and McDonnell on September 18 established the ground rules for the first mission: the trajectory was to be ballistic with a range of about 2200 miles; primary objective was to obtain thermodynamics and structures data; secondary objective was partial qualification of spacecraft systems.

Abstract of Meetings on: Mission Planning and Guidance, Sept. 26; Electrical Systems, Sept. 26, 1962; McDonnell, "Project Gemini Mission Plan, Spacecraft No. 1," Sept. 14, 1962.

1962
September
6

12

14

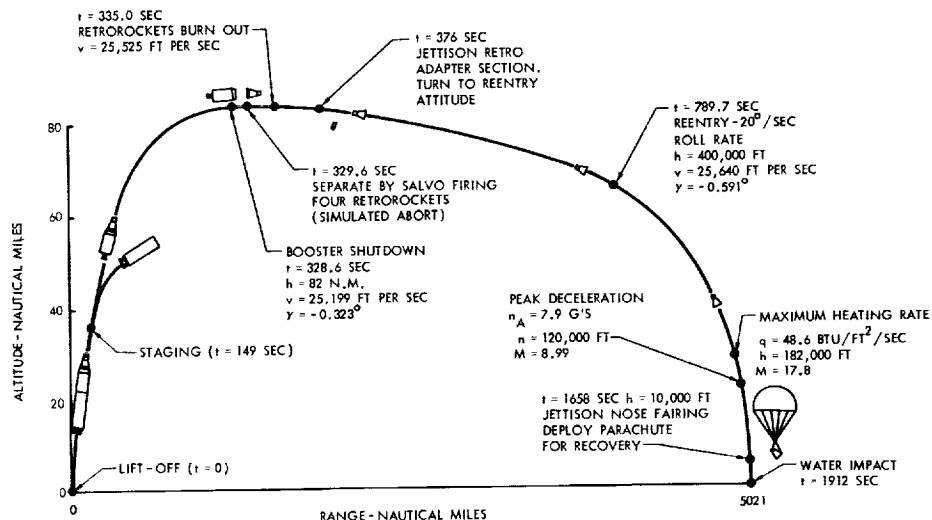

Figure 40.—McDonnell's proposed sequence of events for the first Gemini mission. (McDonnell, "Project Gemini Mission Plan, Spaccraft No. 1," Sept. 14, 1962, p. 7.)

1962
September
17

At the University of Houston's Cullen Auditorium, Director Robert R. Gilruth of Manned Spacecraft Center (MSC) introduced the nine men who had been selected for the MSC flight crew training program for Gemini and Apollo flights. Of the nine, four were from the Air Force, three were from the Navy, and two were civilians. From the Air Force were Major Frank Borman and Captains James A. McDivitt, Edward H. White II, and Thomas P. Stafford. The Navy volunteers were Lieutenant Commanders James A. Lovell, Jr., and John W. Young, and Lieutenant Charles Conrad, Jr. The two civilians were Neil A. Armstrong and Elliot M. See, Jr.

Quarterly Status Report No. 2, p. 29.

- 19 ACF Electronics delivered an engineering prototype radar beacon to McDonnell. An engineering prototype C-band beacon had operated at ACF Electronics under simulated reentry conditions with no degradation in performance.

Quarterly Status Report No. 3, p. 24.

- 19 Life Systems Division reported on continuing studies related to extravehicular operations during Gemini missions. These included evaluation of a superinsulation coverall, worn over the pressure suit, for thermal protection; ventilation system requirements and hardware; and methods of maneuvering in proximity to the spacecraft.

Abstract of Meeting on Mechanical Systems, Sept. 21, 1962.

- 25 A preliminary design criteria review conference for complex 14, held in Los Angeles, resulted in ground rules for all contractors. Target dates established were (1) stand availability, July 1, 1963; (2) estimated beneficial occupancy date, November 1, 1963; and (3) vehicle on-stand date, February 1, 1964. Complex 14 would be used for launching the Gemini-Agena target vehicle and the Mariner spacecraft, but basic modifications would be primarily for the

Gemini program. On November 15, 1962, Air Force Space Systems Division reviewed the criteria summary report for complex 14 modifications and suggested only minor engineering changes.

1962
September

Quarterly Status Report No. 3, pp. 33-34.

Air Force Space Systems Division revised the Development Plan for the Gemini launch vehicle. The budget was raised to \$181.3 million. Cost increases in work on the vertical test facility at Martin's Baltimore plant, on the conversion of pad 19 at Cape Canaveral, and on aerospace ground equipment had already generated a budget increase to \$172.6 million during September. The new Development Plan also indicated that the first launch date had slipped to December 1963.

October
1

Minutes of Project Gemini Management Panel Meeting held at MSC, Nov. 13, 1962; letter, Col. R. C. Dineen to MSC, Subj: Budget Requirements for Gemini Launch Vehicle, Oct. 4, 1962; Harris, *Gemini Launch Vehicle Chronology*, p. 12.

Manned Spacecraft Center (MSC) published the Gemini Program Instrumentation Requirements Document (PIRD), the basis for integrating the worldwide Manned Space Flight Network to support the Gemini program. In compiling PIRD, MSC had received the assistance of other NASA installations and Department of Defense components responsible for constructing, maintaining, and operating the network.

3

Quarterly Status Reports: No. 2, pp. 28-29; No. 3, p. 35.

At a mechanical systems coordination meeting, McDonnell presented its final evaluation of the feasibility of substituting straight tube brazed connections for threaded joints as the external connections on all components of the spacecraft propulsion systems. McDonnell had begun testing the brazing process on June 26, 1962. Following its presentation, McDonnell was directed to make the change, which had the advantages of reducing leak paths and decreasing the total weight of propulsion systems.

3

Quarterly Status Report No. 3, p. 15; Abstracts of Meetings on Mechanical Systems, June 29, Oct. 25, 1962; "Gemini Propulsion by Rocketdyne," pp. 8-9.

McDonnell and Lockheed reported on radiation hazards and constraints for Gemini missions at a Trajectories and Orbits Coordination meeting. McDonnell's preliminary findings indicated no radiation hazard for normal Gemini operations with some shielding; with no shielding the only constraint was on the 14-day mission, which would have to be limited to an altitude of 115 nautical miles. Lockheed warned that solar flares would pose a problem at higher altitudes. Lockheed also recommended limiting operations to under 300 miles pending more data on the new radiation belts created by the Atomic Energy Commission's Project Dominic in July 1962.

5

Abstract of Meeting on Trajectories and Orbits, Oct. 24, 1962; Loyd S. Swenson, Jr., James M. Grimwood, Charles C. Alexander, *This New Ocean: A History of Project Mercury*, NASA SP-4201, p. 467.

Associate Director Walter C. Williams of Manned Spacecraft Center (MSC) invited top-level managers from all major government and contractor organizations participating in the Gemini program to become members of a Project

12

1962
October

Gemini Management Panel. These invitations had arisen from discussions between Williams and MSC Director Robert R. Gilruth on the inevitable problems of program management and technical development. The panel, chaired by George M. Low, Director, Spacecraft and Flight Missions, Office of Manned Space Flight, met first on November 13, 1962. In addition to NASA and Air Force representatives, the panel membership included vice presidents of McDonnell, Martin, Aerospace, Aerojet-General, and Lockheed. A similar development-management structure had worked well in Project Mercury, minimizing delays in communication and providing fast reactions to problems.

Letter, Williams to von Braun *et al.*, Oct. 12, 1962; Minutes of Project Gemini Management Panel Meeting held at MSC, Nov. 13, 1962; House Subcommittee on Manned Space Flight of the Committee on Science and Astronautics, Hearings on H.R. 9641, 1965 NASA Authorization [No. 1], Part 2, 88th Cong., 2nd Sess., 1964, p. 376.

- 15 NASA awarded a contract to International Business Machines Corporation to provide the ground-based computer system for Projects Gemini and Apollo. The contract cost was \$36,200,018. The computer complex would be part of the Integrated Mission Control Center at Manned Spacecraft Center, Houston.

NASA Contrast No. NAS 9-906, Oct. 15, 1962.

- 19 Wesley L. Hjernevik, Manned Spacecraft Center (MSC) Assistant Director for Administration, described to members of MSC's senior staff the implications of NASA Headquarters' recent decision to cut the MSC budget for fiscal year 1963 from \$687 million to \$660 million, the entire reduction to be borne by the Gemini program. Hjernevik feared that the Gemini budget, already tight, could absorb so large a cut only by dropping the paraglider, Agena, and all rendezvous equipment from the program. Gemini Project Office (GPO) reported that funding limitations had already forced Martin and McDonnell to reduce their level of activity. The first Gemini flight (unmanned) was rescheduled for December 1963, with the second (manned) to follow three months later, and subsequent flights at two-month intervals, with the first Agena (fifth mission) in August or September 1964. This four-month delay imposed by budget limitations required a large-scale reprogramming of Gemini development work, reflected chiefly in drastic reduction in the scale of planned test programs. Details of the necessary reprogramming had been worked out by December 20, when GPO Manager James A. Chamberlin reported that December 1963 was a realistic date for the first Gemini flight. Gemini funding for fiscal year 1963 totaled \$232.8 million.

MSC Minutes of Senior Staff Meeting, Oct. 19, 1962, pp. 2, 4; Minutes of Project Gemini Management Panel Meetings held at MSC, Nov. 13, and at SSD, Dec. 20, 1962; Minutes of the first meeting, Gemini Program Planning Board, Feb. 8, 1963, with enc., "Gemini Launches—Master Schedule," Dec. 19, 1962.

- 25 Manned Spacecraft Center informed Lockheed that Gemini program budget readjustments required reprogramming the Gemini-Agena program. Subsequent meetings on November 2 and November 20 worked out the changes necessary to implement the Agena program at minimum cost. The overall test program for the Agena and its propulsion systems was significantly reduced, but in general neither the scope nor the requirements of the Agena program were altered. The major result of the reprogramming was a four-month slip

in the scheduled launch date of the first Agena (to September 1964); this delay was about a month and a half less than had been anticipated when reprogramming began. In addition, Lockheed was to continue its program at a reduced level through the rest of 1962, a period of about six weeks, and to resume its normal level of activity on January 1, 1963.

1962
October

Quarterly Status Reports: No. 3, p. 32; No. 4, p. 32; Abstracts of Meetings on Reprogramming Atlas/Agena, Nov. 9 and 27, 1962; Lockheed *Agena Monthly Progress Reports: October*, p. 8; *November 1962*, pp. 3, 9.

The apogee of the basic spacecraft orbit model was set at 167 nautical miles, the perigee of the elliptical orbit at 87. The altitude of the circular orbit of the target vehicle was to be 161 nautical miles.

31

Abstract of Meeting on Trajectories and Orbits Panel, Nov. 1, 1962.

Minneapolis-Honeywell delivered two engineering prototype attitude control and maneuver electronics systems to the prime contractor. McDonnell installed one of these systems in the electronic systems test unit (ESTU) and conducted subsystems compatibility checks, using the prototype horizon scanners. The ESTU was a simplified spacecraft mock-up with provisions for monitoring all electronic components in their flight locations. Testing began on November 19.

During
the
month

Quarterly Status Report No. 3, p. 19; McDonnell *Final Report*, p. 33.

Goddard Space Flight Center announced the award of contracts totaling approximately \$12 million to modify NASA's Manned Space Flight Tracking Network to support long-duration and rendezvous missions. The contracts were with the Canoga Electronics Corporation, Van Nuys, California, for the tracking antenna acquisition aid system (\$1.045 million); Radiation, Inc., Melbourne, Florida, for digital command encoders (\$1.95 million); Collins Radio Company, Dallas, Texas, for the radio frequency command system (\$1.725 million); and Electro-Mechanical Research, Inc., Sarasota, Florida, for the pulse code modulation system (\$7,376,379).

November
5

Goddard News Release, Nov. 5, 1962; Goddard, *The Manned Space Flight Tracking Network*, 1965, pp. 23-24, 34-36, 41-42, 44.

B. F. Goodrich delivered a prototype partial-wear, quick-assembly, full-pressure suit to Manned Spacecraft Center (MSC) for evaluation by Life Systems Division. The partial-wear feature of this suit, demanded by the long-duration missions planned for the Gemini program, comprised detachable suit components (sleeves, legs, helmets). This was the second of two partial-wear suit prototypes called for by the original contract; but MSC had, in the meantime, requested B. F. Goodrich to provide 14 more suits based on this design. The additional suits varied only in size; they were to follow the design of the prototype according to the specifications of October 10, 1962. The prototype, originally designated G-2G, became G-2G-1 and the remaining suits were designated G-2G-2 through G-2G-15. MSC requested extensive design changes after evaluating G-2G-1 and several other suits. The final model was G-2G-8, delivered to MSC on January 21, 1963. It was later rejected in favor of a suit designed by David Clark Company, Inc., Worcester, Massachusetts, which incorporated B. F. Goodrich helmets, gloves, and additional hardware.

6

1962
November

Quarterly Status Report No. 4, p. 19; James V. Correale and Walter W. Guy, "Space Suits," NASA-MSC Fact Sheet No. 116, December 1962, pp. 2-3; Richard S. Johnston, Correale, and Matthew I. Radnofsky, "Space Suit Development Status," NASA Technical Note D-3291, February 1966, p. 2; "Goodrich Final Report," pp. 75-76.

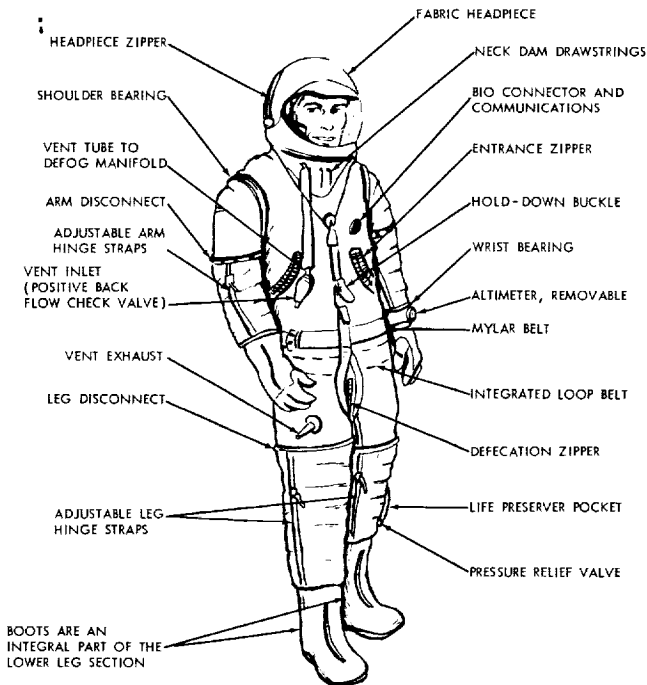

Figure 41.—The B. F. Goodrich partial-wear full-pressure suit being developed for the Gemini program. (B. F. Goodrich Aerospace and Defense Products, "Design, Development, and Fabrication of Prototype Pressure Suits, Final Report," Feb. 1, 1965, p. 10.)

9

Sled ejection test No. 1 was conducted at Naval Ordnance Test Station. Despite its designation, this test did not call for seats actually to be ejected. Its purpose was to provide data on the aerodynamic drag of the test vehicle and to prove the test vehicle's structural soundness in preparation for future escape system tests. The test vehicle, mounted by boilerplate spacecraft No. 3 (a welded steel mock-up of the Gemini spacecraft aerodynamically similar to the flight article), was a rocket-propelled sled running on tracks. Although test objectives were achieved, the boilerplate spacecraft was severely damaged when one of the sled motors broke loose and penetrated the heatshield, causing a fire which destroyed much instrumentation and equipment. Despite repairs required for the boilerplate and major modification or rebuilding of the sled, Gemini Project Office foresaw no delay in the sled test program.

MSC Minutes of Senior Staff Meeting, Nov. 16, 1963, p. 3; Quarterly Status Report No. 3, p. 18; letter, Gordon P. Cress and C. E. Heimstadt, Weber Aircraft, to MSC Historical Office, May 12, 1967; McDonnell *Final Report*, p. 26.

Andre J. Meyer, Jr., of Gemini Project Office reported that Space Technology Laboratories was conducting a study for NASA Headquarters on a "T-back" pod to be used in the spacecraft adapter as the rendezvous target instead of the Agena. The pod would be stabilized but would have no translation capabilities. Although it would be almost as expensive as the Agena, it would avoid separate launch problems.

1962
November
16

MSC Senior Staff Meeting, Nov. 16, 1962, pp. 3-4.

At a mechanical systems coordination meeting, representatives of McDonnell and Manned Spacecraft Center decided to terminate McDonnell's subcontract with CTL Division of Studebaker for the backup heatshield. The decision resulted from growing confidence in the new McDonnell design as well as from CTL problems in fabricating heatshield No. 1. Termination of the CTL contract would save an estimated \$131,000.

21

Message, Chamberlin to Burke, Nov. 23, 1962; Quarterly Status Report No. 3, p. 7; Abstract of Meeting on Mechanical Systems, Nov. 23, 1962.

Gemini Project Office identified the primary problem area of the spacecraft liquid propellant rocket systems to be the development of a 25-pound thruster able to perform within specification over a burn time of five minutes. Three-minute chambers for the reaction control system (RCS) had been successfully tested, but the longer-duration chambers required for the orbit attitude and maneuver system (OAMS) had not. Rocketdyne was three weeks behind schedule in developmental testing of RCS and OAMS components, and five weeks behind in systems testing.

30

Quarterly Status Report No. 3, pp. 16-17.

Gemini Project Office reported revised facilities plans for implementing the preflight checkout of the Gemini spacecraft at Cape Canaveral. Project Gemini facilities were no longer to be wholly contained in the Hangar S complex on Cape Canaveral. Schedule changes and the elimination of incompatibilities between Apollo and Gemini spacecraft fuel-oxidizer and cryogenic systems made

30

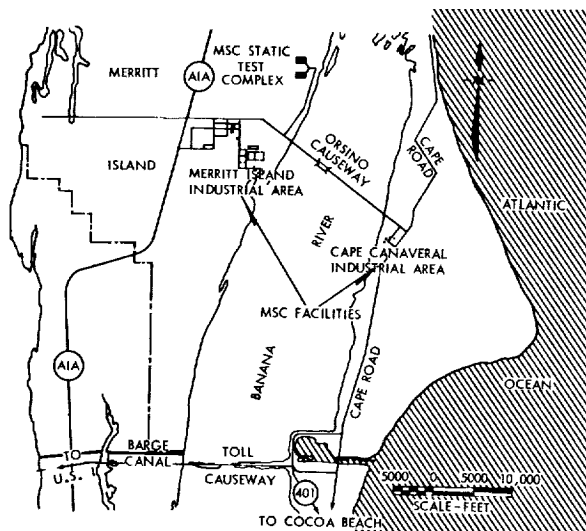

Figure 42.—Location of Manned Spacecraft Center facilities at Cape Canaveral and Merritt Island. (NASA, "Manned Spacecraft Center Atlantic Missile Range Operations, 1959-1964 Facilities," Apr. 15, 1963).

1962
November

feasible the integration of Gemini facilities with the Apollo facilities planned for construction on Merritt Island. The first two Gemini spacecraft would be checked out in Hangar AF (as previously planned), but as soon as the Merritt Island facilities were complete the entire preflight checkout operation would shift to Merritt Island. The Merritt Island facilities were scheduled to be completed in the first quarter of 1964.

Quarterly Status Report No. 3, pp. 42-43; MSC Technical Services Branch, Manned Spacecraft Center Atlantic Missile Range Operations: 1959-1964 Facilities, Apr. 15, 1964, pp. 3-4.

During
the
month

During the first three weeks of the month, Air Force Space Systems Division and Martin-Baltimore negotiated the terms of the contract for Phase I of the Gemini launch vehicle program. The resulting cost-plus-fixed-fee contract included an estimated cost of \$52.5 million and a fixed fee of \$3.465 million. This contract covered the development and procurement of the first launch vehicle and preparations for manufacturing and procuring the remaining 14 vehicles required by the Gemini program.

Harris, *Gemini Launch Vehicle Chronology*, p. 14; interview, George F. MacDougall, Jr., Houston, June 2, 1967.

December
10

North American began deployment flight testing of the half-scale test vehicle (HSTV) in Phase II-A of the Paraglider Development Program. The HSTV was carried aloft slung beneath a helicopter. The main purpose of the deployment flight tests was to investigate problem areas in the transition from release of the rendezvous and recovery canister to glide—the ejection, inflation, and deployment of the paraglider wing. The first flight partially substantiated the feasibility of the basic deployment sequence, but emergency recovery procedures were necessary. In the second test (January 8, 1963), the sail disintegrated, and in the third (March 11), the rendezvous and recovery canister failed to separate. In both instances, attempts to recover the vehicle with the emergency system were thwarted when the main parachute failed to deploy, and both vehicles were destroyed on impact.

Figure 43.—Gemini paraglider half-scale test vehicle slung beneath an Army helicopter at the beginning of the second deployment flight test. (NAA-S&ID Photo 277/4, Jan. 4, 1963.)



Quarterly Status Reports: No. 4, p. 10; No. 5 for Period Ending May 31, 1963, p. 13; NAA Monthly Progress Letters on Phase II-A: No. 13, Jan. 18; No. 14, Feb. 27; No. 16, Apr. 23, 1963; "Paraglider Final Report," pp. 184-188.

1962
December

Representatives of Manned Spacecraft Center, NASA Headquarters, Flight Research Center, Langley Research Center, and Ames Research Center conducted a Design Engineering Inspection of the full-scale test vehicle (FSTV) for Phase II-A of the Paraglider Development Program. As conceived during Phase I of the program, the FSTVs (the contract called for two) were to be a means of meeting a twofold objective: (1) the development of systems and techniques for wing deployment and (2) the evaluation of flight performance and control characteristics during glide. After reviewing flight test objectives, test vehicle hardware, and electrical and electronic systems, the inspecting team submitted 24 requests for alterations to North American.

10-11

Quarterly Status Report No. 4, pp. 10-11; NAA Monthly Progress Letter on Phase II-A, No. 13, Jan. 18, 1963; "Paraglider Final Report," p. 203.

A 10-percent fluctuating-pressure model of the Gemini spacecraft completed its exit configuration test program in the mach number range of 0.6 to 2.5, the region of maximum dynamic pressure. On January 15, 1963, a Gemini spacecraft dynamics stability model also completed its test program providing

14



Figure 44.—The 10-percent model of the Gemini spacecraft used in wind tunnel testing at McDonnell. (McDonnell Photo D4E-250564, undated.)

dynamic stability coefficients for the spacecraft reentry at mach numbers 3.0 to 10. These tests completed all the originally scheduled wind tunnel testing for Project Gemini; however, three additional test programs had been initiated.

1962
December

These included additional testing of the spacecraft 20-percent ejection seat model, testing of the astronaut ballute model to obtain data for design of the astronaut stabilization system, and testing of the rigid frame paraglider model to determine optimum sail configuration.

Quarterly Status Report No. 4, p. 20.

17

The newly formed Scientific Experiments Panel met to solicit proposals for scientific experiments to be performed on Gemini and Apollo flights. The panel was a Manned Spacecraft Center organization whose function would be to receive, evaluate, and implement these proposals.

Memo, Meyer to GPO, Subj: Scientific Experiments to be Conducted on Further Gemini Missions, Dec. 20, 1962.

19

Titan II flight N-11, the eighth in a series being conducted by the Air Force to develop the weapon system, was launched from Cape Canaveral. It carried a design change intended to reduce the amplitude of longitudinal oscillations which had appeared during first stage operation on all seven previous Titan II flights. This phenomenon, which subsequently became known as POGO, generated g-forces as high as nine in the first stage and over three at the position on the missile corresponding to the location of the spacecraft on the Gemini launch vehicle. Fearing the potentially adverse effect on astronaut performance of such superimposed g-forces, NASA established 0.25 g at 11 cycles per second as the maximum level tolerable for Gemini flights. As a first try at solving the POGO problem, Titan II N-11 carried standpipes in each leg of the stage I oxidizer feed lines to interrupt the coupling between the missile's structure and its propulsion system. This coupling was presumed to be the cause of the instability. Postflight analysis, however, revealed that the POGO fix was unsuccessful; longitudinal oscillation had actually been multiplied by a factor of two.

Quarterly Status Reports: No. 2, p. 24-25; No. 3, p. 28; Aerospace, Gemini Launch Vehicle, Fiscal 1962-63; Harris, *Gemini Launch Vehicle Chronology*, p. 20. (NOTE: POGO is not an acronym.)

26

Air Force Space Systems Division established the Gemini Launch Vehicle Configuration Control Board to draw up and put into effect procedures for approving and disapproving specifications and engineering change proposals for the Gemini launch vehicle. It formally convened for the first time on March 5, 1963.

Harris, *Gemini Launch Vehicle Chronology*, p. 16.

During
the
month

Air Force Space Systems Division and Aerojet-General negotiated a cost-plus-fixed-fee contract for the first phase of the Gemini launch vehicle engine program, February 14, 1962, through June 30, 1963. The contract required delivery of one set of engines, with the remaining 14 sets included for planning purposes. Estimated cost of the contract was \$13.9 million, with a fixed fee of \$917,400 for a total of \$14,817,400.

Harris, *Gemini Launch Vehicle Chronology*, p. 15; MacDougall interview, June 2, 1967.

PART II

Development and Qualification



PART II

Development and Qualification

Manned Spacecraft Center directed McDonnell to study requirements for a spacecraft capable of performing rendezvous experiments on the second and third Gemini flights. The experimental package would weigh 70 pounds and would include an L-band radar target, flashing light, battery power supply, and antenna systems. On the second flight, a one-day mission, the experiment was to be performed open-loop, probably optically—the astronaut would observe the target and maneuver the spacecraft to rendezvous with it. On the third flight, a seven-day mission, the experiment was to be performed closed-loop, with spacecraft maneuvers controlled automatically by the data it received from its instruments.

1963
January
4

Memo, Carl R. Huss to Chief, FOD, Subj: Comments and Notes from Project Gemini Mission Planning and Guidance Meeting held January 4, 1963 and January 16, 1963, Jan. 23, 1963; Abstract of Meeting on Mission Planning and Guidance and Control Analysis, Jan. 9, 1963.

Representatives of Manned Spacecraft Center, NASA Headquarters, Flight Research Center, Langley Research Center, and Ames Research Center conducted a Design Engineering Inspection of the advanced trainer for the Paraglider Development Program, Phase II-B(1). North American received 36 requests for alterations.

8-9

Quarterly Status Report No. 4, p. 11; NAA Monthly Progress Letter on Phase II-B(1), No. 7, Feb. 27, 1963.

Manned Spacecraft Center outlined requirements for McDonnell to consider concerning aborts in orbit. These included onboard controlled reentry for all aborts, except in the event of guidance and control system failure; onboard selection of one of the emergency abort target areas; navigational accuracy to a two-mile radius error at the point of impact; and crew capability to eject from the spacecraft with the paraglider deployed.

8-9

Abstract of Meeting on Rendezvous and Reentry Guidance, Jan. 15, 1963.

Flight Operations Division outlined detailed requirements for the remote stations of the worldwide tracking network. Each station would need five consoles:

9

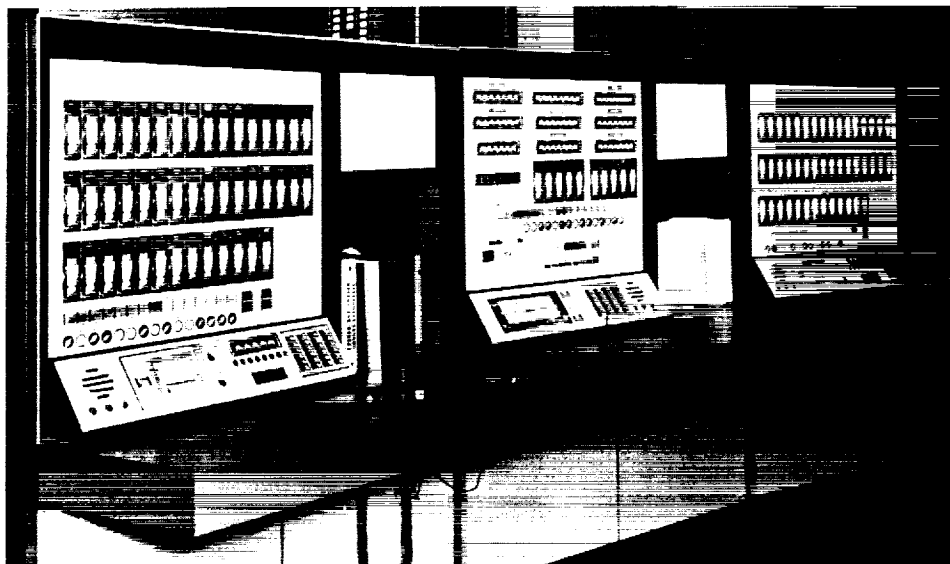
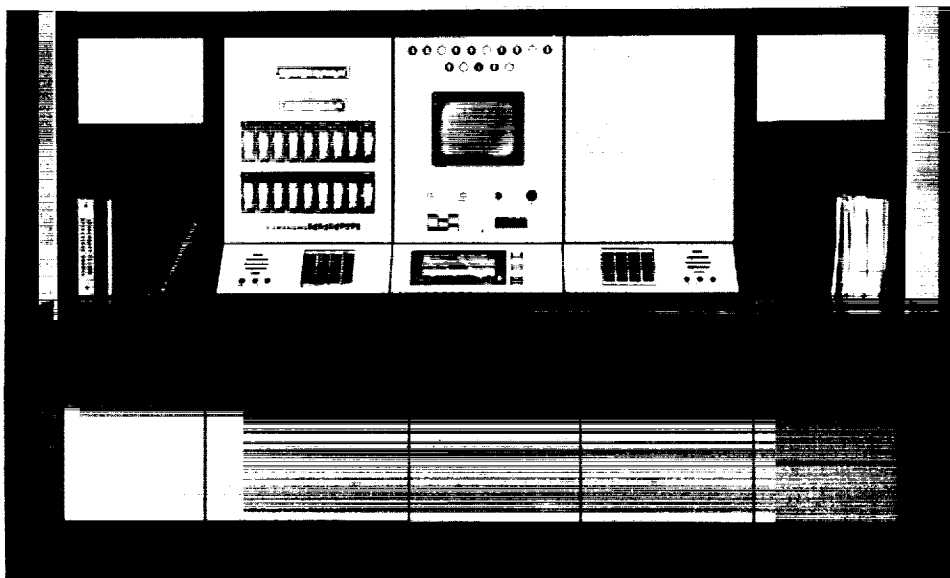

Figure 45.—The five consoles to be installed in each tracking network remote station. (NASA Photos S-63-22136 and S-63-22135, undated.)



1963
January

Gemini system, Agena system, command, aeromedical, and maintenance and operations. The Gemini and Agena consoles would have 42 analog display meters and 40 on/off indicators.

Abstract of Meeting on PCM Working Group, Jan. 16, 1963.

10

Representatives of Manned Spacecraft Center (MSC), McDonnell, and the Eagle-Picher Company, Joplin, Missouri, met to review plans for developing and testing the silver-zinc batteries for the Gemini spacecraft. McDonnell had

1963
January

selected Eagle-Picher as vendor for the batteries about 6 months earlier. Current plans called for five batteries to provide part of the primary (main bus) electrical power requirements during launch, and all primary electrical power for one orbit, reentry, and the postlanding period. Three additional high-discharge-rate batteries, isolated electrically and mechanically from the main batteries, provided power to control functioning relays and solenoids. Eagle-Picher completed a test plan proposal on February 9. On February 21, MSC directed McDonnell to use four batteries instead of five for main bus power on spacecraft Nos. 2 and up, after McDonnell's analysis of battery power requirements disclosed that a four-battery installation, if closely monitored, would be adequate.

Quarterly Status Reports: No. 1, p. 30; No. 2, pp. 20-21; No. 4, p. 25; Abstract of Meeting at Eagle-Picher Concerning Test Program for Gemini Silver Zinc Batteries, Jan. 10, 1963; Abstract of Meeting on Electrical Systems, Feb. 21, 1963; Eagle-Picher, "Proposed Eagle-Picher Test Plan, Gemini Silver Oxide-Zinc Batteries," Feb. 9, 1963.

To stimulate contractor employees to better performance, Gemini Project Office Manager James A. Chamberlin suggested that astronauts visit with workers at various contractors' plants. Donald K. Slayton, Astronaut Activities Office, informed Chamberlin that such visits would be made, beginning with the Martin Company in February 1963.

11

MSC Minutes of Senior Staff Meeting, Jan. 11, 1963, p. 4.

In the opinion of Flight Operations Division's Project Gemini working group: "One of the biggest problem areas seems to be the [spacecraft] on-board computer; exactly what is it going to do; what is its sequence of operation; what does it need from the ground computer complex and how often; exactly how is it used by astronauts; what is the job of the on-board computer for early missions?"

14

Memo, Huss to Chief, FOD, Subj: Summary of Project Gemini FOD Working Group Meeting of Jan. 14, 1963, Jan. 24, 1963.

Manned Spacecraft Center (MSC) assumed complete responsibility for the Gemini target vehicle program from Marshall Space Flight Center following a meeting between MSC and Marshall on January 11 establishing procedures for the transfer. Marshall was to continue to participate actively in an advisory capacity until March 1 and thereafter as technical consultant to MSC upon request. All other NASA Atlas-Agena programs were transferred to Lewis Research Center in a move aimed at freeing Marshall to concentrate on Saturn launch vehicle development and consolidating Atlas launch vehicle technology at Lewis. NASA Headquarters had decided to effect the transfer on October 12, 1962.

14

Letters: Chamberlin to Hans Hueter, Marshall, Subj: Gemini Target Vehicle Program, Jan. 18, 1963; MSC to MSFC, Subj: Gemini Target Vehicle Program, Jan. 18, 1963; MSFC Light and Medium Vehicles Office. "Agena Monthly Progress Report for December 1962," p. 1; NASA *Ninth Semiannual Report to Congress, January 1-June 30, 1963*, p. 76.

NASA Administrator James E. Webb and Secretary of Defense Robert S. McNamara signed a new agreement on Department of Defense (DOD) and

17

1963
January

NASA management responsibilities in the Cape Canaveral area. The Air Force would continue as single manager of the Atlantic Missile Range and host agency at the 15,000-acre Cape Canaveral launch area. NASA's Launch Operations Center would manage and serve as host agency at the Merritt Island Launch Area, north and west of existing DOD installations. DOD and NASA would each be responsible for their own logistics and administration in their respective areas. Specific mission functions—e.g., preparation, checkout, launch, test evaluation—would be performed by each agency in its own behalf, regardless of location. DOD retained certain fundamental range functions, including scheduling, flight safety, search and rescue operations, and downrange airlift and station operation.

Agreement between the Department of Defense and National Aeronautics and Space Administration regarding management of the Atlantic Missile Range of DOD and the Merritt Island Launch Area of NASA, Jan. 17, 1963.

21

James E. Webb, Administrator of NASA, and Robert S. McNamara, Secretary of Defense, concluded a major policy agreement defining the roles of NASA and Department of Defense (DOD) in Project Gemini. The agreement provided for the establishment of a joint NASA-DOD Gemini Program Planning Board. The board would plan experiments, conduct flight tests, and analyze and disseminate results. NASA would continue to manage Project Gemini, while DOD would take part in Gemini development, pilot training, preflight checkout, launch, and flight operations, and would be specifically responsible for the Titan II launch vehicle and the Atlas-Agena target vehicle. DOD would also contribute funds toward the attainment of Gemini objectives.

Agreement between DOD and NASA concerning the Gemini Program, Jan. 21, 1963.

22

In an electrical systems coordination meeting at Manned Spacecraft Center, results of operating the first fuel cell section were reported: a fuel cell stack

Figure 46.—Gemini fuel cell stack. (McDonnell, "Project Gemini Familiarization Manual: Manned Spacecraft Rendezvous Configuration," June 1, 1962, p. 4-6.)

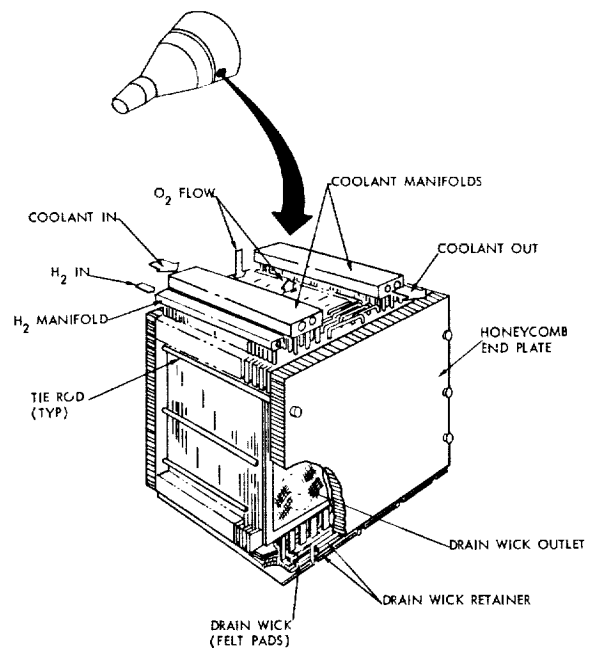

1963
January

had failed and the resultant fire had burned a hole through the case. Another section was being assembled from stacks incorporating thicker ion-exchange membranes. One such stack, of six fuel cells, had operated for 707 hours within specification limits, and after 875 hours was five percent below specified voltage; a similar stack was well within specification after operating 435 hours.

Abstract of Meeting on Electrical Systems, Jan. 29, 1963.

North American received a letter contract for Phase III, Part 1, of the Paraglider Development Program, to produce a Gemini paraglider landing system. This contract was subsequently incorporated as Change No. 6 to Contract NAS 9-539, Phase II-B(1) of the Paraglider Development Program.

22

Quarterly Status Report No. 4, p. 11; NAA letter 65MA3479, Subj: A Final Fee Settlement Proposal for Contract NAS 9-1484, Mar. 18, 1965, p. V-52.

Manned Spacecraft Center announced specialty areas for the nine new astronauts: trainers and simulators, Neil A. Armstrong; boosters, Frank Borman; cockpit layout and systems integration, Charles Conrad, Jr.; recovery systems, James A. Lovell, Jr.; guidance and navigation, James A. McDivitt; electrical, sequential, and mission planning, Elliot M. See, Jr.; communications, instrumentation, and range integration, Thomas P. Stafford; flight control systems, Edward H. White II; and environmental control systems, personal and survival equipment, John W. Young.

26

MSC News Release 63-13, Jan. 26, 1963.

At a launch guidance and control coordination meeting, Aerospace described three Titan II development flight failures that had been caused by problems in the General Electric Mod III airborne radio guidance system. Although these failures did not appear to be the result of inherent design faults that might react on the Gemini program, Aerospace felt that a tighter quality assurance program was needed: "GE has a poor MOD III (G) quality control program, basically poor workmanship."

29-30

Memo, John C. O'Loughlin to Chief, FOD, Subj: Report on the Launch Guidance and Control Panel Meeting of January 29 and 30, 1963, Feb. 13, 1963; Abstract of Meetings on Launch Guidance and Control, Feb. 8, 1962.

Gemini Project Office asked NASA Headquarters for authorization to use pre-flight automatic checkout equipment for Project Gemini. The Mercury program had been successful in everything except meeting schedules, in which lengthy checkout time was a major obstacle. Automatic checkout equipment could cut down the time required to test components in Gemini. After reviewing this request, George M. Low, Director of Spacecraft and Flight Missions, Office of Manned Space Flight, asked that four automatic checkout stations be provided for Project Gemini as quickly as possible. Initially approved, the use of automatic checkout equipment in the Gemini program was subsequently dropped as an economy measure.

30

Memos, Chamberlin to Low, Subj: Justification for the use of PACE (Preflight Automatic Checkout Equipment) on the Gemini Program, Jan. 30, 1963; Low to Director, Integration and Checkout, Subj: Justification of Use of PACE in the Gemini Program, Feb. 15, 1963; Quarterly Status Report No. 6 for Period Ending Aug. 31, 1963, p. 84. (NOTE: Use of the acronym "PACE" was subsequently

PROJECT GEMINI: A CHRONOLOGY

1963

dropped at the insistence of a computer company claiming prior rights to the name.).

February
5

Crew Systems Division representatives presented results of investigations into equipment and procedures for extravehicular operations. McDonnell was to begin a review of current extravehicular capabilities and to proceed with a study of requirements. Areas of study were to include (1) extent of crew maneuverability with hatch closed and cabin pressurized as currently provided, (2) requirements to allow the crew to stand in open hatches but not actually leave the cabin, and (3) requirements to allow a crew member to leave the cabin and inspect the spacecraft's exterior. McDonnell was directed to provide for extravehicular operations for spacecraft Nos. 2 and up.

NASA-MSD Consolidated Activity Report for the Office of the Director, Manned Space Flight, Jan. 27-Feb. 23, 1963, p. 62 (hereafter cited as Consolidated Activity Report); Abstract of Meeting on Mechanical Systems, Feb. 8, 1963.

5-6

At a Gemini Rendezvous and Reentry Panel meeting, it was reported that attempts to obtain information on flight controller procedures to command the Agena in orbit had been delayed by the Air Force Agena security program.

Memo, M. P. Frank to Chief, FOD, Subj: Gemini Rendezvous and Reentry Panel Meeting, Feb. 11, 1963.

6

Titan II development flight N-16 was launched from Cape Canaveral. This was the eleventh Titan II flight and the third to use increased pressure in the propellant tanks of stage I to reduce longitudinal oscillations (POGO). This was successful in reducing POGO levels to about 0.5 g, more than satisfactory from the standpoint of the weapon system. The Air Force was reluctant to expend weapon system funds in an effort to reduce POGO still further to the 0.25-g level NASA regarded as the maximum acceptable for manned flight.

MSD Minutes of Senior Staff Meeting, Mar. 22, 1963, p. 5; Consolidated Activity Reports: Jan. 27-Feb. 23, pp. 3-4; Feb. 24-Mar. 23, 1963, p. 4; Quarterly Status Report No. 5, p. 40.

6

Astronaut trainees concluded their formal academic training with a course on orbital mechanics and flight dynamics. Flight crew personnel had been receiving basic science training for two days a week over the past four months. During this period, they also received Gemini spacecraft and launch vehicle familiarization courses and visited several contractor facilities, including McDonnell, Martin, Aerojet, and Lockheed. Among subjects studied were astronomy, physics of the upper atmosphere and space, global meteorology, selenology, guidance and navigation, computers, fluid mechanics, rocket propulsion systems, aerodynamics, communications, environmental control systems, and medical aspects of space flight. Flight-crew training plans for the rest of the year, which were being formulated during February, called for space science and technology seminars, celestial recognition training, monitoring the Mercury-Atlas 9 flight, weightless flying, pressure suit indoctrination, parachute jumping, survival training, instruction in spacecraft systems and launch support, paraglider flying, centrifuge experience, docking practice, and work with the flight simulator.

MSD Minutes of Senior Staff Meeting, Jan. 4, 1963, p. 7; Consolidated Activity Report, Jan. 27-Feb. 23, 1963, p. 2; Quarterly Status Report No. 4, pp. 36-37.

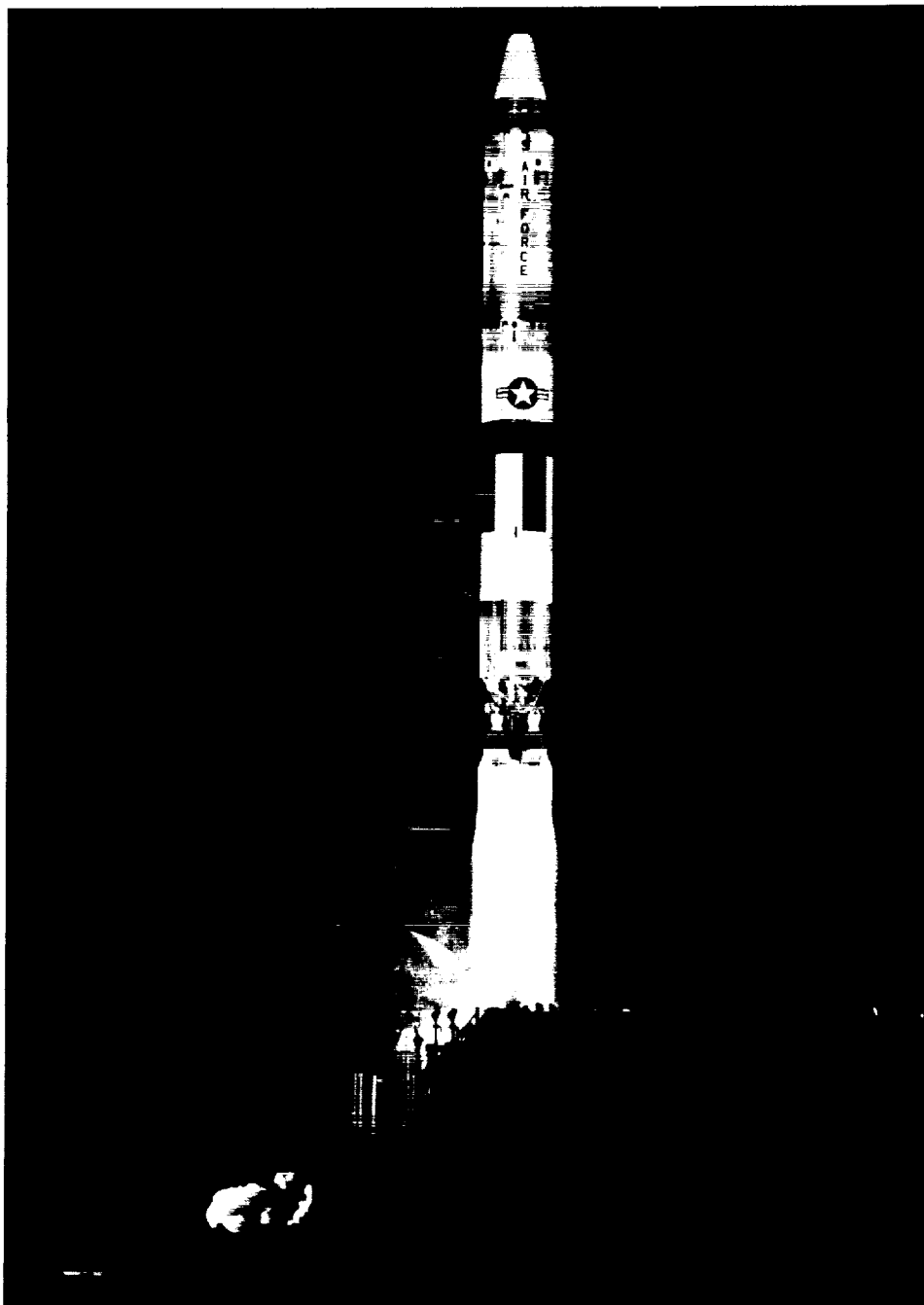

Figure 47.—Titan II flight N-15 was launched from Cape Canaveral on January 10, 1963. It was the tenth in the series of Titan II research and development flights, and the second to achieve significantly reduced levels of longitudinal oscillation by means of propellant tank pressurization. (USAF Photo 33-1, Jan. 10, 1963.)

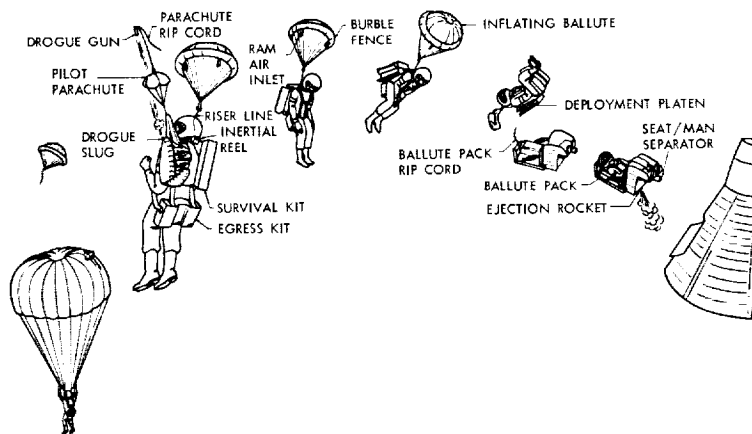

Figure 48.—Proposed deployment sequence for the ballute stabilization device. (NASA Photo No. 63-Gemini-12, Jan. 18, 1963.)

1963
February
7

Simulated off-the-pad ejection test No. 8 was conducted at Naval Ordnance Test Station. Two dummies were ejected, and for the first time the test incorporated a ballute system. The ballute (for *balloon* + parachute) had been introduced as a device to stabilize the astronaut after ejection at high altitudes. Ejection seat and dummy separated satisfactorily and the personnel parachute deployed properly; but faults in the test equipment prevented the canopy from fully inflating. The ballute failed to inflate or release properly on either dummy. As a result, the parachute was redesigned to ensure more positive inflation at very low dynamic pressures. The redesigned chute was tested in a series of five entirely successful dummy drops during March.

Consolidated Activity Report, Feb. 24–Mar. 23, 1963, p. 3; Quarterly Status Reports: No. 4, pp. 18–19; No. 5, p. 26; letter, Cress and Helmstadt to MSC Historical Office, May 12, 1967.

8

Colonel Kenneth W. Schultz of Headquarters, Air Force Office of Development Planning, outlined Department of Defense objectives in the Gemini program at the first meeting of the Gemini Program Planning Board. He defined three general objectives: conducting orbital experiments related to such possible future missions as the inspection and interception of both cooperative and passive or noncooperative objects in space under a variety of conditions, logistic support of a manned orbiting laboratory, and photo reconnaissance from orbit; gaining military experience and training in all aspects of manned space flight; and assessing the relationship between man and machine in the areas of potential military missions.

Minutes of the First Meeting, Gemini Program Planning Board, Feb. 8, 1963, pp. 2–3, and enc. 2, "DOD Considerations for Discussion at the Initial Meeting of the Gemini Program Planning Board."

8

Northrop Ventura successfully completed the first series of 20 drop tests in developing the parachute recovery system for Project Gemini. The first four drops, during the last two weeks of August 1962, used a dummy rendezvous and recovery (R and R) section with the 18-foot drogue parachute to determine the rate of descent of the R and R section. Subsequent drops tested the 84-foot ring-

1963
February

sail main parachute using boilerplate spacecraft No. 1, a steel mock-up of the Gemini spacecraft ballasted to simulate the weight and center of gravity of the flight article. Boilerplate No. 1, manufactured by McDonnell, was delivered to Northrop Ventura on August 1. Drops Nos. 5 and 6 were simple weight drops to determine the structural characteristics of the main parachute. Beginning with drop No. 7, tests were conducted through the entire sequencing of the system from an altitude of 10,000 feet. Through drop No. 13, the main problem was tucking; the edge of the parachute tended to tuck under, hindering full inflation. Drop tests Nos. 5 through 13 were conducted from September through November 1962. The tucking problem was resolved with drop No. 14. Remaining tests in the series demonstrated the structural integrity of the parachute system when deployed at maximum dynamic pressure and provided data on loads imposed by deployment at maximum dynamic pressure. Qualification drop tests were expected to begin in April.

Quarterly Status Reports: No. 2, p. 13; No. 3, pp. 13-14; No. 4, pp. 11-12; MSC *Space News Roundup*, Jan. 23, 1963, pp. 1-2; McDonnell *Final Report*, p. 25.

The first biweekly Network Coordination Meeting was held. Gemini Project Office had established the meetings to ensure the compatibility of ground network equipment configuration with mission requirements and airborne systems. At a meeting on November 20, 1962, the PCM (Pulse Code Modulation) Working Group had concluded that Project Gemini telemetry system presented no major compatibility problems.

13

Quarterly Status Reports: No. 3, p. 35; No. 4, p. 35; Abstract of Meeting on Ground Network, Feb. 15, 1963.

Agna target vehicle checkout plans were presented at a meeting of the Gemini Management Panel. Upon receipt at Cape Canaveral, the target vehicle would be inspected and certified. After this action, mechanical mate and interface checks with the target docking adapter would be accomplished. Agna-Gemini spacecraft compatibility tests would then be conducted, and the Agna would undergo validation and weight checks. Subsequently, a joint checkout of the spacecraft and Agna would be conducted with tests on the Merritt Island radar tower.

15

Minutes of Project Gemini Management Panel Meeting held at Cape Canaveral, Fla., Feb. 15, 1963.

In a letter transmitting copies of the Gemini Launch Vehicle Pilot Safety Program to Gemini contractors and other organizations engaged in Gemini development and operations, Air Force Space Systems Division explained that pilot safety philosophy and procedures would be carried over from Mercury-Atlas to Gemini-Titan.

18

Letter, Dineen to Chamberlin, Feb. 18, 1963.

Gemini Project Office (GPO) decided that spacecraft separation from the launch vehicle would be accomplished manually on spacecraft Nos. 2 and up. In addition, no second-stage cutoff signal to the spacecraft would be required. GPO directed McDonnell to remove pertinent hardware from the spacecraft and Martin to recommend necessary hardware changes to the launch vehicle.

26-27

Abstract of Meeting on Launch Guidance and Control, Mar. 5, 1963.

1963
February
28

Gemini Project Office reported that spacecraft No. 3 had been reassigned to the Gemini flight program. It had originally been scheduled for use in Project Orbit tests, a program of simulated manned orbital flights in the McDonnell vacuum chamber. Static article No. 1, which had been intended for load tests of the paraglider, ejection seat, hatch, and cabin pressurization, was redesignated spacecraft No. 3A and replaced spacecraft No. 3 in the Project Orbit test program. A McDonnell review of the entire static test program in December 1962 had resulted in eliminating static article No. 1 and making static articles Nos. 3 and 4 the primary structural test articles. No. 3 was to be subjected to launch, reentry, abort, landing, and parachute loads; and No. 4 to seat, hatch, and pressurization loads plus dynamic response tests.

Quarterly Status Reports: No. 3, p. 5; No. 4, pp. 3, 7.

28

Gemini Project Office (GPO) published a bar chart depicting preflight check-out of the Gemini spacecraft in the industrial area at Cape Canaveral. The chart outlined tests on all sections of the spacecraft, the target docking adapter, and the paraglider, from initial receiving inspection through completion of preparations for movement to the launch pad. GPO expected industrial area testing to take about 90 working days, based on two full shifts of testing per day and a third shift of partial testing and partial maintenance.

Quarterly Status Report No. 4, pp. 40, 44.

28

Gemini Project Office reported Rocketdyne's successful achievement of the full 270-second burn-time duration specified for steady-state operation of the orbit attitude and maneuver system (OAMS) 25-pound thruster. This had been the primary focus of Rocketdyne's research effort, in line with McDonnell's position that meeting steady-state life operations with the 25-pound OAMS thrust chamber assembly (TCA) was the key to resolving major problems in the development of spacecraft liquid propulsion systems. McDonnell engineers believed that a TCA design able to meet the steady-state life performance required of the 25-pound OAMS TCA would also be adequate to meet pulse-life performance requirements, and that a satisfactory 25-pound TCA would only have to be enlarged to provide a satisfactory 100-pound TCA. They were wrong on both counts. Rocketdyne subsequently shifted its primary TCA effort to obtaining life during pulse operation for 25-pound thrusters and steady-state life operation for 100-pound thrusters.

Quarterly Status Reports: No. 4, pp. 16-17; No. 5, p. 24.

March
1

The stage II oxidizer tank from Gemini launch vehicle (GLV) 2 was airlifted from Martin-Denver to Martin-Baltimore to be used in GLV-1. GLV propellant tank and skirt assemblies were manufactured, pressure-tested, and calibrated at Martin-Denver, then shipped to Baltimore where the GLV was assembled. Martin-Denver had begun major weld fabrication of GLV-1 and GLV-2 tanks in September 1962 and delivered the GLV-1 tanks to Martin-Baltimore October 10. After extensive testing, the tanks went through a roll-out inspection February 14-16, 1963, by Air Force, NASA, Aerospace, and Martin personnel. The inspecting team rejected the stage II oxidizer tank because it was found to be cracked. The rejected tank was returned to Denver and replaced by the GLV-2 stage II oxidizer tank.

Gemini Program Mission Report for Gemini-Titan 1 (GT-1), May 1964, p. 12-6; Aerospace Final Report, p. II. F-1; Gemini-Titan II Air Force Launch Vehicle, p. D-1; Harris, Gemini Launch Vehicle Chronology, p. 17.

1963
March

Gemini Project Office discussed with contractors the establishment of a philosophy for the final phase of the rendezvous mission. They agreed on the following general rules: (1) when the launch was on time, the terminal maneuver would be initiated when the Agena came within range of the spacecraft's sensors, which would occur between spacecraft insertion and first apogee; (2) automatic and optical terminal guidance techniques would always back each other up, one method being selected as an objective for each mission and the other serving as a standby; (3) during early rendezvous missions, the terminal phase would be initiated by the third spacecraft apogee or delayed until the twelfth because of range radar tracking limitations; (4) for the same reason, no mid-course corrections should be made during orbits 4 through 11; (5) in case of extreme plane or phase errors, the Agena would be maneuvered to bring it within the spacecraft's maneuver capability; and (6) after such gross Agena maneuvers, the Agena orbit would be recircularized and two orbits of spacecraft catchup would precede the initiation of terminal rendezvous plan.

5

Abstract of Meeting on Trajectories and Orbits, Mar. 8, 1963.

Figure 49(A).—Procedure for assembling fuel and oxidizer tanks for stage I of the Gemini launch vehicle. (Martin Photo 8B65793, undated.)

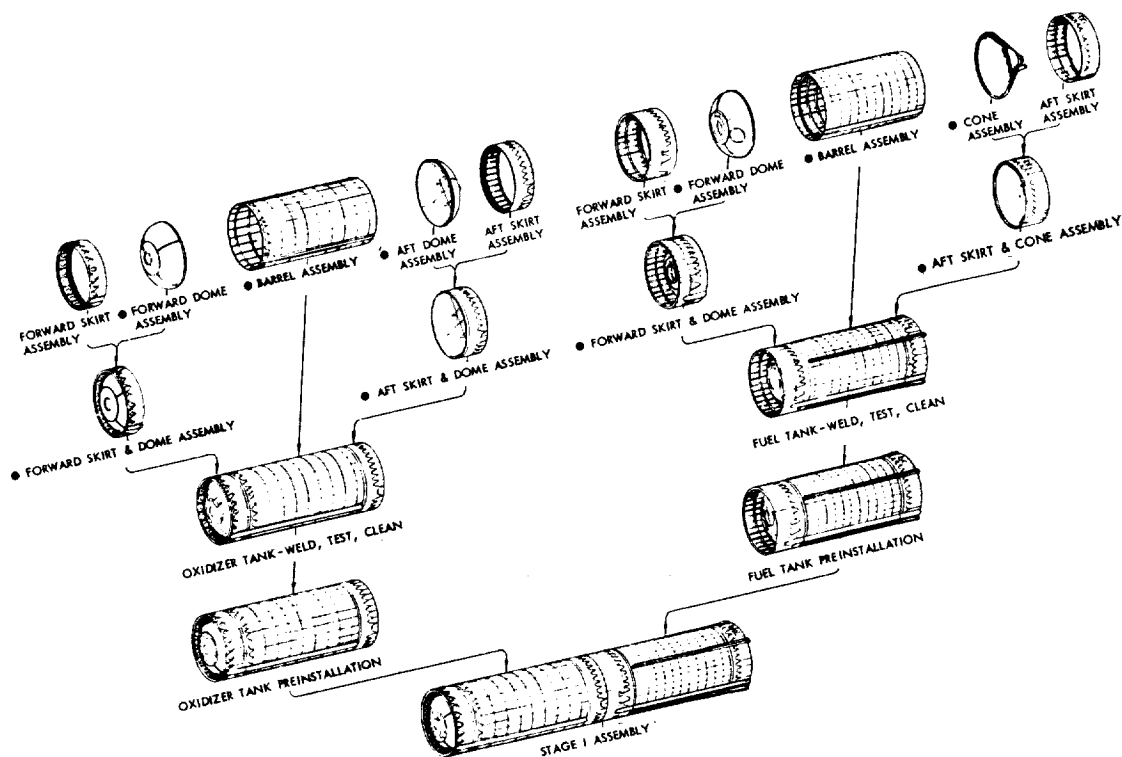

(A)

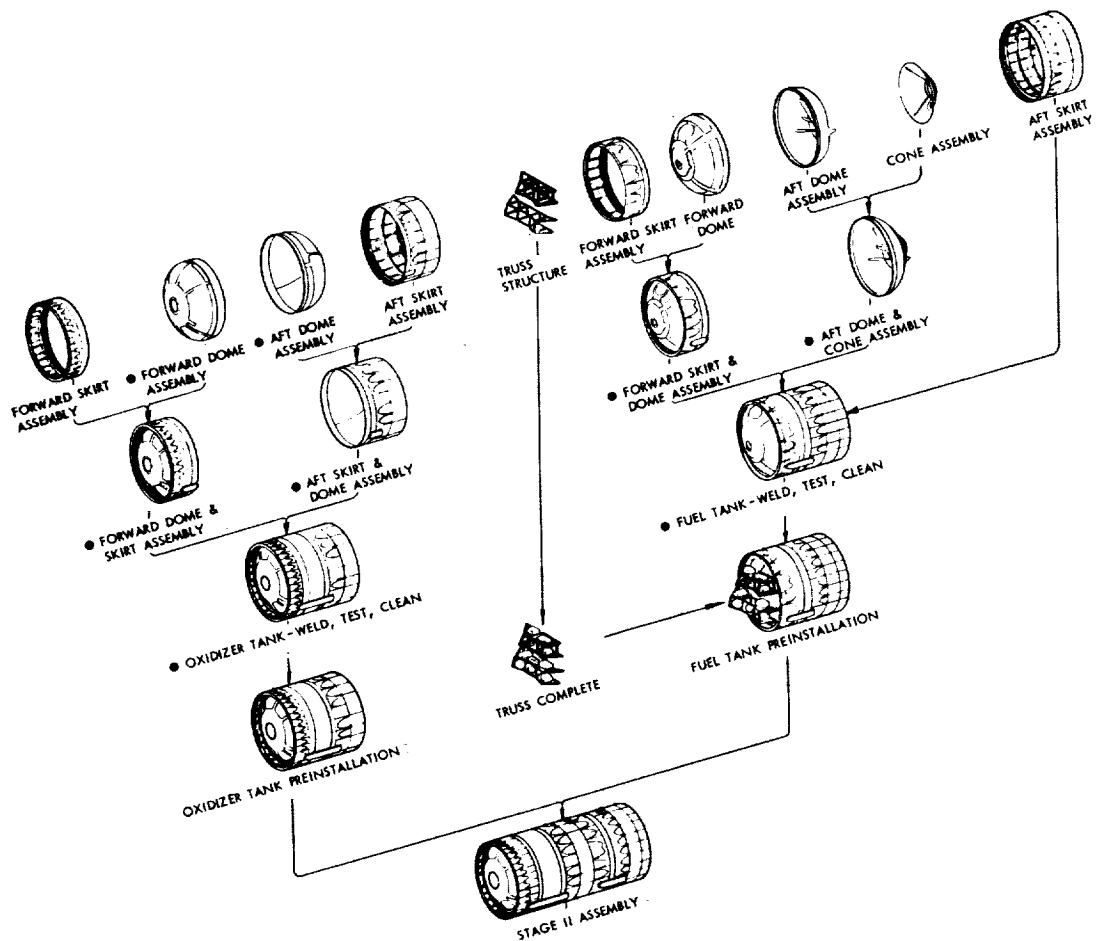

(B)

Figure 49 (B).—Procedure for assembling fuel and oxidizer tanks for stage II of the Gemini launch vehicle. (Martin Photo 8B65794, undated.)

1963
 March
 7

The Gemini Program Planning Board, meeting in Washington, agreed to the establishment of an ad hoc study group to compare NASA and Department of Defense (DOD) objectives for the Gemini program and to recommend DOD experiments for inclusion in the Gemini flight program. The group met in continuous session March 25 to April 26, presenting its final report to the board on May 6. The board then recommended that a program of inflight military experiments be immediately approved, that the Air Force establish a field office at Manned Spacecraft Center to manage DOD participation in the Gemini program in general and integration of experiments in particular, and that work on preventing longitudinal oscillations in stage I and combustion instability in stage II of the Gemini launch vehicle be urgently pursued. The board declined to recommend additional flights in the Gemini program, as suggested by the study group, to encompass experiments that would not fit into the framework of

the planned Gemini program. The Secretary of Defense and NASA Administrator concurred in the Board's recommendations.

1963
March

Letter, Holmes to Gilruth, Mar. 19, 1963, with enc.; memos, Seamans and Brockway M. McMillan to Secretary of Defense and Administrator, NASA, Subj: Recommendations by the Gemini Program Planning Board, May 29, 1963; McNamara to Co-Chairmen of the GPPB, Subj: Recommendation of the Gemini Program Planning Board, June 20, 1963; Webb to Co-Chairmen, same subject, June 24, 1963; Minutes of Gemini Program Planning Board Meetings, Mar. 12, May 6, 1963.

A series of problems in the Paraglider Development Program culminated in the loss of a second half-scale test vehicle in a deployment flight test. As early as October 19, 1962, budget pressure had prompted some consideration of dropping paraglider from the Gemini program. Paraglider was retained but the Paraglider Development Plan was reoriented. On March 27-28, 1963, representatives of NASA and North American met to discuss several revised paraglider programs as a basis for potential redirection. At a Manned Spacecraft Center (MSC) senior staff meeting on March 29, Andre J. Meyer, Jr., of Gemini Project Office (GPO) reported that GPO now intended to delay use of paraglider until the tenth Gemini mission, although the consensus of the Gemini Management Panel at a meeting on May 2 was that paraglider might yet be ready for spacecraft No. 7 and GPO's Quarterly Status Report for the period ending May 31, 1963, also projected the use of paraglider from flight No. 7 on. In response to an inquiry from MSC, North American reported on April 9 that funds for Contract NAS 9-167 would be exhausted by April 15, and for Contract NAS 9-539 by April 25. Paraglider was downgraded to a research and development program. All three earlier paraglider contracts were terminated; on May 5 a new letter contract, NAS 9-1484, was issued to North American to cover work on what was now called the Paraglider Landing System Program.

11

Messages, R. S. Maynard, Chief, Paraglider Contracts, to Kline, Apr. 9, 1963; R. L. Stottard, Manager, Division Contracts and Proposals, to Kline, Subj: Contracts NAS 9-167 and NAS 9-539, Gemini Paraglider Program, Apr. 10, 1963; MSC Minutes of Senior Staff Meetings: Oct. 29, 1962, p. 2; Mar. 29, p. 5; Apr. 26, 1963, p. 5; Minutes of Project Gemini Management Panel Meeting held at Lockheed, May 2, 1963; Quarterly Status Report No. 5, pp. 13-14, 51; NAA, A Final Fee Settlement Proposal for Contract NAS 9-1484, p. I-1.

North American let the first of three major subcontracts for the Gemini Paraglider Landing System Program to Northrop for a parachute recovery system in the amount of \$461,312. A \$1,034,003 subcontract for the paraglider control actuation assembly went to the Aerospace Division of Vickers, Inc., Detroit, Michigan, on March 25. The third major subcontract, \$708,809 for the paraglider electronic control system, was let to the Aeronautical Division of Minneapolis-Honeywell on May 13.

12

Letter, Dave W. Lang to R. L. Zimmerman, Subj: Case No. 10448-63, Dec. 18, 1964, p. 7.

McDonnell presented results of its study to determine the minimum recycle time in the event of a mission "scrub." Manned Spacecraft Center (MSC) needed this information to determine capability of meeting launch windows on successive days in the rendezvous portion of the Gemini program. According to the company's best estimate, recycle would require at least 24½ hours. MSC,

14

1963
March

desiring a shorter period, studied whether the recycle could be compressed by doing more concurrent work.

Abstract of Meeting on Spacecraft Operations, Mar. 19, 1963.

19

James A. Chamberlin was reassigned from Manager of Project Gemini to Senior Engineering Advisor to Robert R. Gilruth, Director of Manned Spacecraft Center. Charles W. Mathews was reassigned from Chief, Spacecraft Technology Division, to Acting Manager of Project Gemini.

MSC Space News Roundup, Apr. 3, 1963, p. 8.

20

Qualification tests of the production prototype ablation heatshield for the Gemini spacecraft began. Structural and material properties specimen tests had already shown that the shield either satisfied or exceeded the required design level.

Quarterly Status Report No. 5, p. 55.

21

A meeting at Manned Spacecraft Center established guidelines for extravehicular operations. The current concept of the pressure suit as a single-wall pressure vessel was to be retained; the basic suit could be modified by such additions as a loose thermal covering or gloves and boots. To attach the astronaut to the spacecraft during extravehicular operations, a tether long enough to allow access to the spacecraft adapter section would be used; it would include 12 nylon-encapsulated communications wires. The tether's only purpose was to attach the astronaut to the spacecraft; maneuvering and maintaining stability would be accomplished by other means. Provisions for extravehicular operations were to be provided from spacecraft No. 4 on. One-half hour of useful time outside the cabin was specified as the basis for systems design.

Abstract of Meeting on Extravehicular Operations, May 25, 1963.

21

A contract for \$33,797,565, including fixed fee, was signed with Philco Corporation, Philadelphia, Pennsylvania, to implement the Integrated Mission Control Center. Philco would provide all the flight information and control display equipment except the real-time computer complex, which was to be built and maintained by International Business Machines Corporation. Philco would also assist Manned Spacecraft Center in maintaining and operating the equipment for at least one year after acceptance. Philco had been selected from seven qualified bidders, and final contract negotiations had begun February 25, 1963.

Consolidated Activity Reports: Jan. 27-Feb. 23, p. 29; Feb. 24-Mar. 23, 1963, p. 29;
MSC Space News Roundup, Apr. 3, 1963, p. 8.

April
1

The Titan II-Gemini Coordination Committee was established to direct efforts to reduce longitudinal vibration (POGO) in the Titan II and to improve engine reliability. Air Force Space Systems Division (SSD) and Aerospace Systems had presented to NASA and the Air Force a series of briefings on the POGO problem that culminated in a briefing to the Gemini Program Planning Board. The main problem was that POGO level satisfactory in the weapon system was too high to meet NASA standards for the Gemini program, and further reduction in the POGO level required a much more elaborate and extensive analytic and experimental program than had so far been considered necessary. The board

approved the SSD/Aerospace proposals and established a committee to oversee work toward a POGO remedy. The high-level committee was composed of officials from Air Force Ballistic Systems Division, SSD, Space Technology Laboratories, and Aerospace.

1963
April

Aerospace, Gemini Launch Vehicle, Fiscal 1963-64; Harris, *Gemini Launch Vehicle Chronology*, p. 20.

Testifying before the Subcommittee on Manned Space Flight of the House Committee on Science and Astronautics, D. Brainerd Holmes, Director of Manned Space Flight, sought to justify a \$42.638 million increase in Gemini's actual 1963 budget over that previously estimated. Holmes explained: "This increase is identified primarily with an increase of \$49.9 million in spacecraft. The fiscal 1963 congressional budget request was made at the suggestion of the contractor. The increase reflects McDonnell's six months of actual experience in 1963." The subcommittee was perturbed that the contractor could so drastically underestimate Gemini costs, especially since it was chosen without competition because of supposed competence derived from Mercury experience. Holmes attributed McDonnell's underestimate to unexpectedly high bids from subcontractors and provided for the record a statement of some of the reasons for the change: "These original estimates made in December 1961 by NASA and McDonnell were based on minimum changes from Mercury technology. . . . As detailed specifications for subsystems performance were developed . . . realistic cost estimates, not previously available, were obtained from subcontractors. The first of these . . . were obtained by McDonnell in April 1962 and revealed significantly higher estimates than were originally used. For example: (a) In data transmission, it became necessary to change from a Mercury-type system to a pulse code modulation (PCM) system because of increased data transmission requirements, and the need to reduce weight and electrical power. The Gemini data transmission system will be directly applicable to Apollo. (b) Other subsystems have a similar history. The rendezvous radar was originally planned to be similar to ones used by the Bomarc Missile, but it was found necessary to design an interferometer type radar for low weight, small volume, and to provide the highest reliability possible. (c) The environmental control system was originally planned as two Mercury-type systems, but as the detail specifications became definitive it was apparent that the Mercury ECS was inadequate and, although extensive use of Mercury design techniques were utilized, major modifications were required."

2

House Subcommittee on Manned Space Flight of the Committee on Science and Astronautics, Hearings on H.R. 5466, *1964 NASA Authorization* [No. 3], Part 2(a), 88th Cong., 1st Sess., 1963, pp. 576, 581-582, 584.

NASA announced the signing of a contract with McDonnell for the Gemini spacecraft. Final negotiations had been completed February 27, 1963. Estimated cost was \$428,780,062 with a fixed fee of \$27,870,000 for a total estimated cost-plus-fixed-fee of \$456,650,062. NASA Headquarters spent two weeks on a detailed review of the contract before signing. Development of the spacecraft had begun in December 1961 under a preliminary letter contract which the final contract superseded. The contract called for 13 flight-rated spacecraft, 12 to be used in space flight, one to be used for ground testing. In addition, McDonnell would provide two mission simulator trainers, a docking simulator trainer,

2

1963
April

five boilerplates, and three static articles for vibration and impact ground tests.

MSC Minutes of Senior Staff Meeting, Mar. 22, 1963, p. 5; Consolidated Activity Report, Feb. 24-Mar. 23, 1963, p. 4; NASA Negotiated Contract, Contract NAS 9-170, Contract for Project Gemini Two-Man Spacecraft Development Program, Feb. 27, 1963; *1964 NASA Authorization*, pp. 585, 1456; *Aeronautics and Astronautics, 1963: Chronology on Science, Technology, and Policy*, NASA SP-4004, p. 120.

- 9 George M. Low, Director of Spacecraft and Flight Missions, Office of Manned Space Flight, explained to the House Subcommittee on Manned Space Flight why eight rendezvous missions were planned: "In developing the rendezvous capability, we must study a number of different possible ways of conducting the rendezvous. . . . For example, we can conduct a rendezvous maneuver in Gemini by purely visual or optical means. In this case there will be a flashing light on the target vehicle. The pilot in the spacecraft will look out of his window and he will rendezvous and fly the spacecraft toward the flashing light and perform the docking. This is one extreme of a purely manual system. On the opposite end of the spectrum we have a purely automatic system in which we have a radar, computer, and stabilized platform and, from about 200 or 500 miles out, the spacecraft and the target vehicle lock on to each other by radar and all maneuvers take place automatically from that point on. We know from our studies on the ground and our simulations that the automatic way is probably the most efficient way of doing it. We would need the least amount of fuel to do it automatically. On the other hand, it is also the most complex way. We need more equipment, and more equipment can fail in this maneuver so it might not be the most reliable way. The completely visual method is least efficient as far as propellants are concerned, but perhaps the simplest. In between there are many possible combinations of these things. For example, we could use a radar for determining the distance and the relative velocity between the two without determining the relative angle between the two spacecraft and let the man himself determine the relative angle. We feel we must get actual experience in space flight of a number of these possibilities before we can perform the lunar orbit rendezvous for Apollo."

1964 NASA Authorization, pp. 649-650.

- 22 Representatives of Air Force Space Systems Division (SSD), Manned Spacecraft Center, and Lockheed met in Sunnyvale for the first management review of the Gemini Agena target vehicle (GATV). Patterned after similar meetings regularly held between SSD, Lewis Research Center, and Lockheed on medium space vehicle satellite and probe programs, the Gemini Target Management Review Meetings encompassed a comprehensive monthly review of the status of the GATV program.

Memo, H. J. Ballard to Distribution, Subj: Minutes of Gemini Target Management Review Meeting, Apr. 23, 1963; *Lockheed Agena Monthly Report, April 1963*, p. 2-3.

- 23-24 The Gemini Abort Panel met. Martin-Baltimore's analysis of the last three Titan II flight tests tended to show that successful crew escape would have been possible. McDonnell presented data on spacecraft structural capabilities, but lack of data on what to expect from a Titan II catastrophic failure meant

that spacecraft structural capabilities remained a problem. Also some questions had existed as to what would happen to the adapter retrosection during and after an abort. A study had been made of this problem, assuming a 70,000-foot altitude condition, and there appeared to be no separation difficulties. This study investigated the period of up to 10 seconds after separation, and there was no evidence that recontact would occur.

1963
April

Memo, James E. Hannigan to Chief, FOD, Subj: Gemini Abort Panel Meeting of April 23 and 24, 1963, May 15, 1963; Abstract of Meeting of Gemini Abort Panel, Apr. 29, 1963.

Final design review of complex 14 modifications and activation of facilities was held under the aegis of Air Force Space Systems Division (SSD) in Los Angeles. All drawings and specifications were accepted. SSD's activation of the complex was scheduled to begin January 1, 1964, with an estimated 10 months required to prepare complex 14 for Project Gemini Atlas-Agena launches.

27

Quarterly Status Report No. 5, p. 45.

NASA Headquarters approved rescheduling of the Gemini flight program as proposed by Gemini Project Office (GPO). Late delivery of the spacecraft systems coupled with the unexpectedly small number of Mercury systems incorporated in the Gemini spacecraft had forced GPO to review the flight program critically. In the revised program, the first flight was still set for December 1963 and was still to be unmanned, but it was now to be orbital rather than suborbital to flight-qualify launch vehicle subsystems and demonstrate the compatibility of the launch vehicle and spacecraft; no separation or recovery was planned. The second mission, originally a manned orbital flight, now became an unmanned suborbital ballistic flight scheduled for July 1964. Its primary objective was to test spacecraft reentry under maximum heating-rate reentry conditions; it would also qualify the launch vehicle and all spacecraft systems required for manned orbital flight. The third flight, formerly planned as a manned orbital rendezvous mission, became the first manned flight, a short-duration (probably three-orbit) systems evaluation flight scheduled for October 1964. Subsequent flights were to follow at three-month intervals, ending in January 1967. Rendezvous terminal maneuvers were planned for missions 3 (if flight duration permitted) and 4, a seven-day mission using a rendezvous pod. The sixth flight was to be a 14-day long-duration mission identical to 4 except that no rendezvous maneuver exercises were planned. Flights 5 and 7 through 12 were to be rendezvous missions with the Atlas-launched Agena D target vehicle. Water landing by parachute was planned for the first six flights and land landing by paraglider from flight 7 on.

29

MSC Minutes of Senior Staff Meetings: Apr. 12, p. 4; Apr. 26, p. 5; May 3, 1963, p. 4; Minutes of Project Gemini Management Panel Meeting held at Lockheed, May 2, 1963; Quarterly Status Report No. 5, pp. 50-51, 58; Minutes, GPO Staff Meeting, Apr. 25, 1963.

In a NASA position paper, stimulated by Secretary of Defense McNamara's testimony on the fiscal year 1964 budget and an article in *Missiles and Rockets* interpreting his statements, Robert C. Seamans, Jr., NASA Associate Administrator, stressed NASA's primary management responsibility in the Gemini

30

1963
March

program. McNamara's remarks had been interpreted as presaging an Air Force take-over of Project Gemini. Seamans recognized the vital role of the Department of Defense in Gemini management and operations but insisted that NASA had the final and overall responsibility for program success.

NASA Position Paper, Subj: DOD Participation in the Gemini Program, Apr. 30, 1963; Frank McGuire, "McNamara Spells Out A.F. Gemini Role," *Missiles and Rockets*, Apr. 1, 1963, p. 15.

During
the
month

Bell Aerosystems successfully completed initial firing of the Gemini Agena Model 8247 engine at its Buffalo plant early in the month. The Model 8247 engine for the Gemini Agena's primary propulsion system was developed from the Model 8096 currently being flown in satellite and probe programs for NASA and the Air Force. Unlike the operational engine, the new engine was capable of being restarted several times in orbit, a Gemini program requirement. The

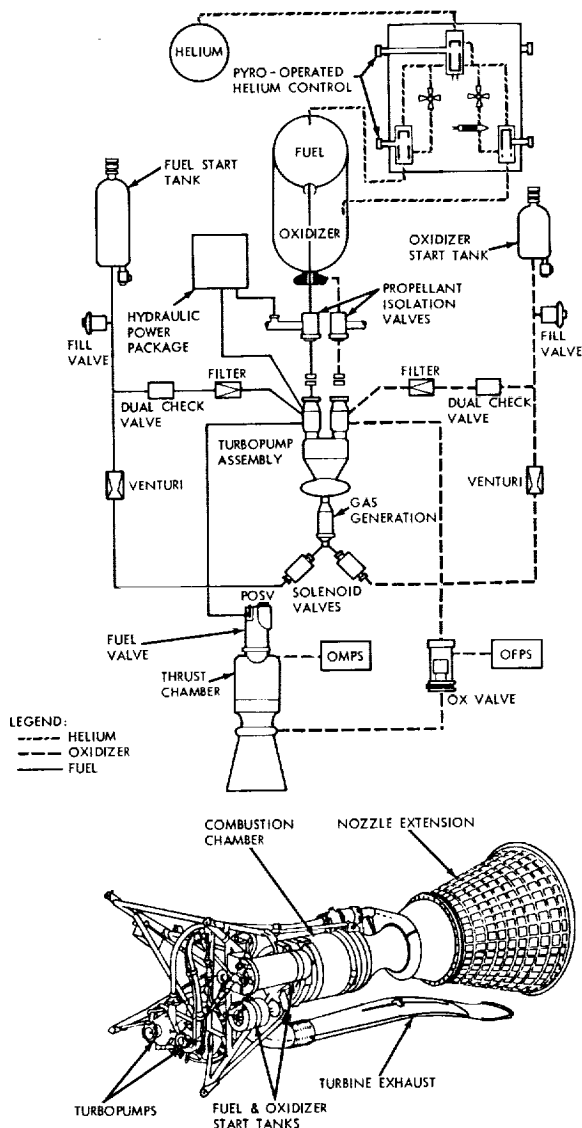

Figure 50.—Schematic and drawing of the primary propulsion system of the Gemini Agena target vehicle. (Lockheed, Gemini Agena Target Press Handbook, LMSC-A766871, Feb. 15, 1966, pp. 4-19, 4-20.)

principle change in the new engine was the substitution of liquid propellants for solid pyrotechnic "starter cans" to start the gas generator. The unit tested was the development engine that had been assembled in March. In mid-April, the test engine was shipped to Arnold Engineering Development Center (AEDC), Tullahoma, Tennessee, for further development tests. At AEDC, test cell arrangements were completed April 12, with testing scheduled to begin in May.

April
1963

Lockheed Agena Monthly Report, April 1963, pp. 2-5, 2-6.

McDonnell began tests to qualify the attitude control and maneuver electronics (ACME) system for the Gemini spacecraft, after completing development testing. Subject of the qualification tests was the first production prototype ACME unit received from Minneapolis-Honeywell.

May
1

Quarterly Status Report No. 5, p. 17.

Charles W. Mathews, new Acting Manager of Project Gemini, reviewed the current status of the spacecraft, launch vehicles, and ground facilities for the Gemini Management Panel. Modifications of launch complexes 19 and 14, of the tracking network, and of Atlantic Missile Range checkout facilities were all on schedule, although no margin remained for complex 19 work. The Atlas and Agena presented no problems, but the Gemini launch vehicle schedule was tight; technical problems, notably stage I longitudinal oscillation and stage II engine instability, were compounded by funding difficulties. The Gemini spacecraft, suffering from late deliveries by subcontractors, was being reprogrammed.

2

Minutes of Project Gemini Management Panel Meeting, May 2, 1963.

Development testing of the Gemini Agena Model 8247 main engine at Arnold Engineering Development Center (AEDC) began with an instrumentation run. After oxidizer contamination resulted in a scrubbed test on May 7, test firing began on May 13. The major objective of AEDC testing was to verify the engine's ability to start at least five times. The AEDC rocket test facility permitted firing of the engine in an environment simulating orbital temperature and pressure. During the course of the tests, two major problems emerged: turbine overspeed and gas generator valve high temperature operations. At the Atlas/Agena coordination meeting of July 2, Air Force Space Systems Division reported that a turbine overspeed sensing and shutdown circuit had been proposed to resolve the first problem and that solutions to the gas generator problem were being intensively investigated.

3

Quarterly Status Report No. 5, p. 43; Abstract of Meeting on Atlas/Agena, July 8, 1963; Lockheed Agena Monthly Report, May 1963, pp. 2-1, 2-2.

NASA awarded Letter Contract NAS 9-1484 to North American for the Paraglider Landing System Program. Work under the contract was to be completed by May 1, 1964, and initial funding was \$6.7 million. This contract reflected a reorientation of the paraglider program. Its primary purpose was to develop a complete paraglider landing system and to define all the components of such a system. Among the major tasks this entailed were: (1) completing the design, development, and testing of paraglider subsystems and building and maintaining mock-ups of the vehicle and its subsystems; (2) modifying the

5

1963
May

paraglider wings produced under earlier contracts to optimize deployment characteristics and designing a prototype wing incorporating aerodynamic improvements; (3) modifying the two full-scale test vehicles produced under Contract NAS 9-167 to incorporate prototype paraglider landing system hardware, modifying the Advanced Paraglider Trainer produced under Contract NAS 9-539 to a tow test vehicle, and fabricating a new, second tow test vehicle; and (4) conducting a flight test program including half-scale tow tests, full-scale boilerplate parachute tests, full-scale deployment tests, and tow test vehicle flight tests. Contract negotiations were completed on July 12, and the final contract was dated September 25, 1963.

Consolidated Activity Report, Apr. 28-May 18, 1963, p. 33; NAA, A Final Fee Settlement Proposal for Contract NAS 9-1484, pp. V-26 to V-51; NAA letter, Subj: Contract NAS 9-1484, Paraglider Landing System Program, Monthly Progress Report No. 3, Aug. 15, 1963.

- 6 The Gemini Program Planning Board approved the Air Force Systems Command development plan for the Gemini/Titan II improvement program. The plan covered the development work required to man-rate the Titan II beyond the requirements of the Titan II weapon system and included three major areas: (1) reducing longitudinal oscillation levels to NASA requirements, (2) reducing the incidence of stage II engine combustion instability, and (3) cleaning up the design of stage I and II engines and augmenting the continuing engine improvement program to enhance engine reliability. The work was to be funded by the Titan Program Office of Air Force Ballistics Systems Division and managed by the Titan II/Gemini Coordination Committee, which had been established April 1. NASA found the plan satisfactory.

Letter, Holmes to Schriever, June 14, 1963: AFSC, "Joint Titan II/Gemini Development Plan on Missile Oscillation Reduction and Engine Reliability and Improvement," Apr. 5, 1963 (rev. May 7, 1963); Minutes of Gemini Program Planning Board Meeting, May 6, 1963.

- 7-17 Aerojet-General delivered the first flight engines for Gemini launch vehicle No. 1 to Martin-Baltimore. Aerojet-General had provided a set of Type "E" dummy engines March 18. These were installed and used to lay out tubing and wiring while the launch vehicle was being assembled. They were later removed and flight engines installed in stage II, May 7, and stage I, May 17. Some rework was required because of differences in configuration between the dummy and flight engines, and engine installation was completed May 21. Wiring and continuity checks followed (May 22-25), and final horizontal tests were completed May 27.

Mission Report for GT-1, p. 12-6; *Gemini-Titan II Air Force Launch Vehicle*, p. D-1; Harris, *Gemini Launch Vehicle Chronology*, p. 23.

- 9 Qualification testing of the Gemini parachute recovery system began at El Centro, California. Boilerplate spacecraft No. 5, a welded steel mock-up of the spacecraft reentry section, was dropped from a C-130 aircraft at 20,000 feet to duplicate dynamic pressure and altitude at which actual spacecraft recovery would be initiated. Four more land-impact tests followed, the last on June 28; all test objectives were successfully accomplished. The main parachute tucking problem, which had appeared and been resolved during development tests, recurred in drops 4 and 5 (June 17, 28). Although this problem did not affect

parachute performance, Gemini Project Office decided to suspend qualification testing until the condition could be studied and corrected. Northrop Ventura attributed the tucking to excessive fullness of the parachute canopy and resolved the problem by adding control tapes to maintain proper circumference. Four bomb-drop tests during July proved this solution satisfactory, and qualification testing resumed August 8.

1963
May

Weekly Activity Reports: June 16–22, p. 3; June 23–29, p. 2; July 21–27, p. 2; July 28–Aug. 3, p. 1; Aug. 4–10, 1963, p. 1; Consolidated Activity Reports: Apr. 28–May 18, p. 69; June 16–July 20, 1963, p. 85; Quarterly Status Reports: No. 5, p. 15; No. 6, p. 17.

Simulated off-the-pad ejection seat testing resumed with test No. 9. McDonnell and Weber Aircraft had completely redesigned the backboard and mechanism linkage to obtain more reliable load paths and mechanism actuation, and to eliminate the “add-on” character of the many features and capabilities introduced during seat development which contributed to the unsuccessful test in February. The new design was proved in a series of tests culminating in a preliminary ejection test on April 22. Test No. 9 was followed by test No. 9a on May 25. Both tests were completely successful. Tests Nos. 10 and 11 (July 2, 16) completed the development phase of pad ejection testing. Both were dual ejection tests. No. 10 was completely successful, but No. 11 was marred by the failure of a seat recovery chute (not part of the spacecraft ejection system), resulting in major damage to the seat when it hit the ground.

15

Weekly Activity Report, June 30–July 6, 1963, p. 1; Consolidated Activity Reports: Apr. 28–May 18, p. 69; May 19–June 15, pp. 74–75; June 16–July 20, 1963, pp. 85, 88–89; Quarterly Status Reports: No. 5, pp. 6, 26; No. 6, p. 41.

Rocketdyne successfully tested a 25-pound thrust chamber assembly (TCA) for the reentry control system (RCS) in pulse operation. Earlier efforts had aimed primarily at achieving steady-state performance, until tests revealed that such performance was no guarantee of adequate pulse performance. Char rate on pulse-cycled, 25-pound RCS TCAs proved to be approximately 1.5 times greater than identical TCAs tested in continuous runs. Several TCAs failed when the ablative material in the combustion chamber was exhausted and the casing charred through. To correct this problem, the ratio of oxidizer to fuel was reduced from 2.05:1 to 1.3:1, significantly decreasing chamber temperature; the mission duty cycle was revised, with required firing time reduced from 142 seconds of specification performance to 101 seconds, without catastrophic failure before 136 seconds; and the thickness of the ablative chamber wall was increased, raising motor diameter from 2.54 to 3.75 inches. The development of a suitable ablative thrust chamber, however, remained a major problem. No RCS TCA design was yet complete, and no 25-pound orbit attitude and maneuver system TCAs had yet been tested on a pulse-duty cycle. Rocketdyne was already three months late in delivering TCA hardware to McDonnell, and all other components had been rescheduled for later delivery. Completion of development testing of components had also been slipped three months.

18

Consolidated Activity Report, Apr. 28–May 18, 1963, p. 71; Quarterly Status Report No. 5, pp. 19–20, 24.

Flight Crew Operations Division reported that the nine new flight crew members had completed a zero-gravity indoctrination program at Wright-Patterson

20

PROJECT GEMINI: A CHRONOLOGY

- 1963
May
- Air Force Base, Ohio, with the support of the 6750th Aerospace Medical Research Laboratory. A modified KC-135 aircraft carried the astronauts on two flights each. A flight included 20 zero-gravity parabolas, each lasting 30 seconds.
- Consolidated Activity Report, Apr. 28-May 18, 1963, p. 27.
- 21
- Manned Spacecraft Center began a Gemini atmospheric reentry simulation study. The fixed-base simulator contained a handcontroller and pilot displays to represent the Gemini reentry vehicle. Purpose of the study was to evaluate manual control of the Gemini spacecraft during reentry, before beginning the centrifuge program to be conducted at Naval Air Development Center. The reentry simulation study was completed June 20.
- Quarterly Status Report No. 6, p. 77.
- 21
- As part of the general revision of the Gemini flight program that NASA Headquarters had approved April 29, representatives of NASA, Air Force Space Systems Division, and Lockheed met to establish basic ground rules for revising Agena development and delivery schedules. The first rendezvous mission using the Agena target vehicle was now planned for April 1965, some seven and one half months later than had been anticipated in October 1962. Six months would separate the second Agena launch from the first, and subsequent flights would be at three-month, rather than two-month, intervals. The revised schedule was agreed on at the Atlas/Agena coordination meeting of June 6-7, 1963. Among the major features of the new schedule: Agena communications and control subsystem development was to be completed by December 1963 (back six weeks); other Lockheed development work was to be completed by January 1964 (back three and one-half months); assembly and modification of the first target vehicle was to start April 2, 1964, with the vehicle to be accepted and delivered in January 1965; the first Atlas target launch vehicle was to be delivered in December 1964; the schedule for component manufacturing and deliveries was to be so arranged that the second target vehicle could back up the first, given about nine months' notice.
- Weekly Activity Report, June 2-8, 1963, p. 3; Quarterly Status Report No. 5, p. 43; Abstract of Meeting on Atlas/Agena, June 12, 1963; Lockheed *Agena Monthly Reports*: May, p. 2-12; July 1963, p. 2-1.
- 23
- The first engineering prototype of the onboard computer completed integration testing with the inertial platform at International Business Machines Corporation (IBM) and was delivered to McDonnell. At McDonnell, the computer underwent further tests. Some trouble developed during the initial test, but IBM technicians corrected the condition and the computer successfully passed diagnostic test checks.
- Quarterly Status Report No. 5, p. 18.
- 27
- North American began testing the half-scale tow test vehicle (HSTTV) for the Paraglider Landing System Program. The first series of tests, 121 ground tows, ended on July 29. Various wing angle settings and attach points were used to provide preliminary data for rigging analysis and dynamic tow characteristics. The HSTTV was then delivered to Edwards Air Force Base on August 19, where Flight Research Center began its own series of ground tows on August 20. This series of 133 runs was concluded in September and was followed by

11 helicopter tow tests in October. Primary test objectives were to investigate paraglider liftoff characteristics, helicopter tow techniques, and the effects of wind-bending during high speed tows.

1963
May

Quarterly Status Report No. 7 for Period Ending Nov. 30, 1963, p. 33; NAA, A Final Fee Settlement Proposal for Contract NAS 9-1484, p. V-111; Paraglider Landing System Program, Monthly Progress Reports: No. 1, June 15; No. 3, Aug. 15; No. 4, Sept. 13; No. 5, Oct. 16; No. 6, Nov. 15, 1963.

Titan II flight N-20, the 19th in the series of Air Force research and development flights, was launched from Cape Canaveral. It carried oxidizer standpipes and fuel accumulators to suppress longitudinal oscillations (POGO). During the spring of 1963, static firings of this configuration had been successful enough to confirm the hypothesis that POGO was caused by coupling between the missile structure and its propulsion system, resulting in an unstable closed loop system. Standpipes and accumulators, by interrupting the coupling, reduced

29

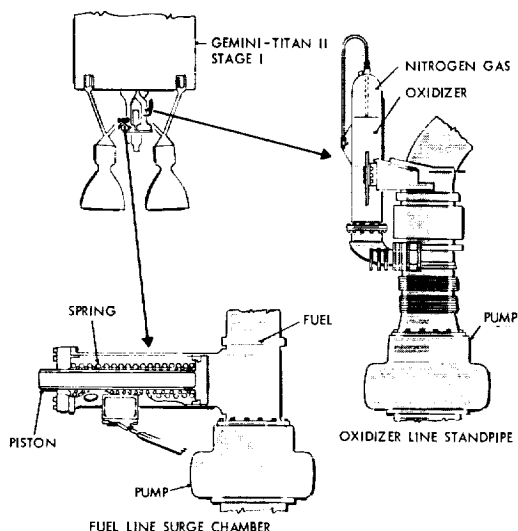

Figure 51.—POGO suppression equipment proved out in the Titan II development program. (Martin Photo 8B65766, undated.)

the source of instability. Flight N-20 failed 55 seconds after launch and yielded no POGO data. Although the failure was not attributed to the installed POGO fix, Air Force Ballistics Systems Division decided officially that no further Titan II development flights would carry the POGO fix because so few test flights remained to qualify the weapon system operationally. This decision did not stand, however, and the POGO fix was flown again on N-25 (November 1), as well as on two later flights.

Quarterly Status Reports: No. 5, p. 40; No. 7, p. 64; No. 8 for Period Ending Feb. 29, 1964, p. 52; Abstract of Meeting on Titan II, July 2, 1963; Aerospace, Gemini Launch Vehicle, Fiscal 1962-63; Harris, *Gemini Launch Vehicle Chronology*, p. 20.

The vertical test facility (VTF) at Martin-Baltimore was activated. The VTF comprised a 165-foot tower and an adjacent three-story blockhouse with ground equipment similar to that used at complex 19. In it, the completely assembled Gemini launch vehicle was tested to provide a basis for comparison

29

PROJECT GEMINI: A CHRONOLOGY

1963
May with subsequent tests conducted at complex 19. Each subsystem was tested separately, then combined systems tests were performed, concluding with the Combined Systems Acceptance Test, the final step before the launch vehicle was presented for Air Force acceptance.

Martin-Baltimore, "Gemini Launch Vehicle Familiarization Manual," November 1965, p. 1-21; *Gemini-Titan II Air Force Launch Vehicle*, p. 4-5; Aerospace Final Report, p. II.F-1; Harris, *Gemini Launch Vehicle Chronology*, p. 25.

During
the
month

Rocketdyne reactivated the test program on the 100-pound thrust chamber assembly (TCA) for the orbit attitude and maneuver system. Through March, testing had been at a very low level as Rocketdyne concentrated on the 25-pound TCAs. Testing had ceased altogether in April because hardware was unavailable. Tests had shown, however, that a satisfactory 100-pound TCA design could not be derived from an enlarged 25-pound TCA design. The major objective of the reactivated test program was to achieve steady-state life. Two tests late in May were encouraging: one achieved 575 seconds of operation with no decay in chamber pressure and a performance efficiency of 92 percent; the other operated for 600 seconds with 10 percent decay in chamber pressure and 91.9 percent performance efficiency. Specification performance was 530 seconds with less than 3 percent chamber pressure decay and 93 percent performance efficiency.

Quarterly Status Report No. 5, pp. 24, 25.

June
2

Stage I of Gemini launch vehicle 1 was erected in Martin-Baltimore's vertical test facility. Stage II was erected June 9, and posterection inspection was completed June 12. Subsystem Functional Verification Tests began June 10.

Mission Report for GT-1, p. 12-6; *Gemini-Titan II Air Force Launch Vehicle*, p. D-1.

4-5

At a Gemini Abort Panel meeting, McDonnell reported the possibility of dropping the mode 2 lower abort limit to 35,000 to 40,000 feet. McDonnell also presented computer data on studies using a combination of mode 2 and mode 1 for launch to T + 10-second aborts; during this period, mode 1 abort might not be adequate. Current Gemini abort modes: mode 1, ejection seats—from pad to 70,000 feet; mode 2, booster shutdown/retrosalvo—from 70,000 to approximately 522,000 feet; mode 3, booster shutdown/normal separation—from approximately 522,000 feet until last few seconds of powered flight.

Memo, David B. Pendley to Chief, FOD, Subj: Gemini Launch Abort Modes, June 20, 1963.

8

Representatives of NASA, Air Force Space Systems Division, Aerospace, McDonnell, and Martin met to initiate an investigation of the structural integrity and compatibility of the spacecraft and launch vehicle during the powered phase of the mission. This had been a problem in the first Mercury-Atlas flight. Contractors were instructed to furnish NASA and Space Systems Division with all available structural data by July 15, 1963.

Weekly Activity Report, June 2-8, 1963, p. 2.

10

Instructors from McDonnell's training department began conducting two weeks of courses on Gemini spacecraft systems for flight controllers at Manned Space-

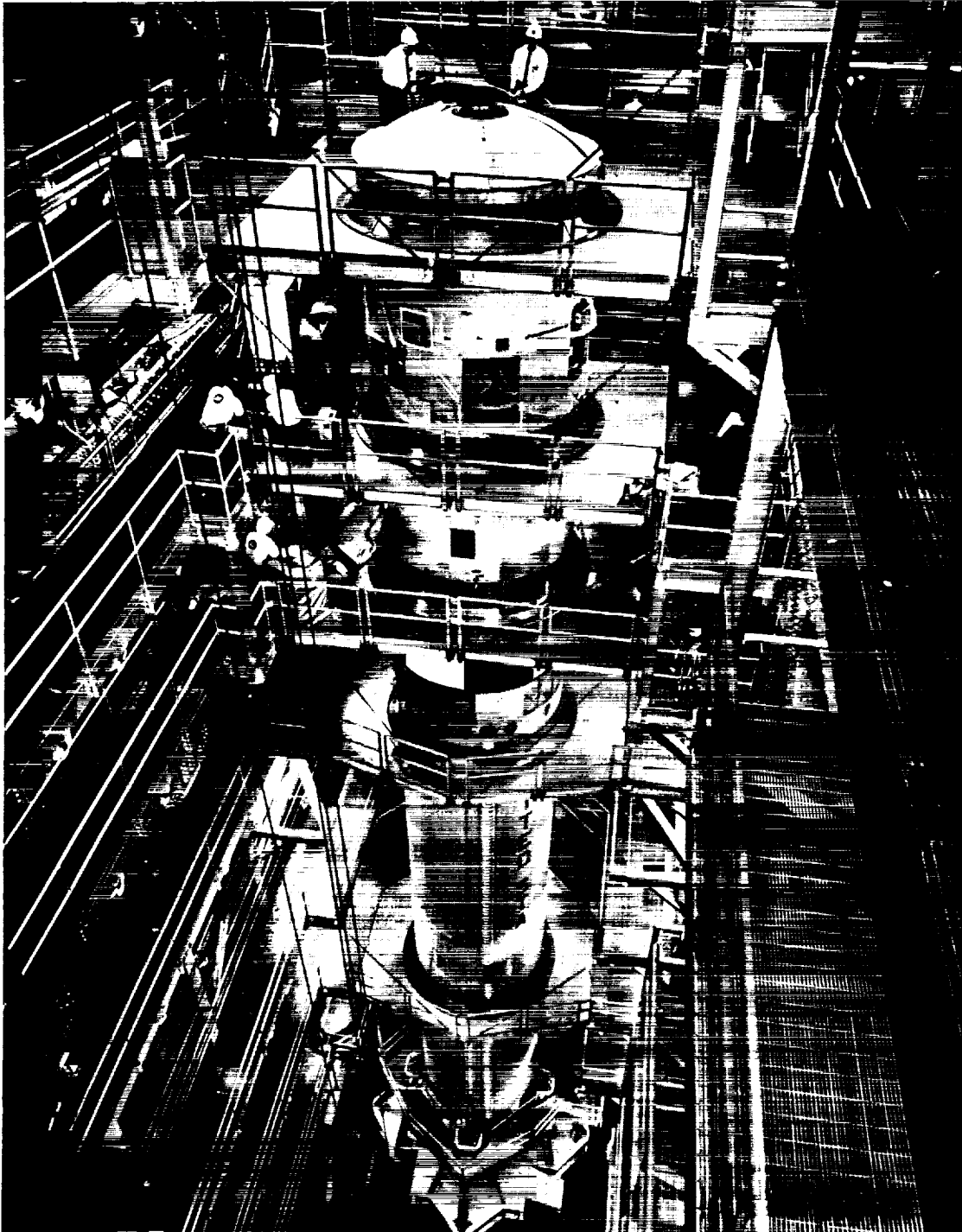

Figure 52.—Gemini launch vehicle 1 undergoing tests in the vertical test facility at Martin's Baltimore plant. (Martin Photo B-58332, undated.)

1963
June

craft Center. During May, the nine new astronauts had received similar instruction; the veteran astronauts went through the same course in late June and early July.

Consolidated Activity Report, May 19–June 15, 1963, p. 23; Quarterly Status Report No. 6, p. 79.

12

The editorial committee formed to compile Gemini Network Operations Directive 63-1 met at Goddard Space Flight Center to plan the writing of the directive. The purpose of this directive was to establish the overall concept of the tracking and instrumentation network for the Gemini program; it was an outgrowth of Mercury Network Operations Directive 61-1, then in force.

Memo, Capt. H. E. May, H. W. Wood, and Capt. H. E. Clements for Record, Subj: Plan for Writing the Gemini Network Operations Directive 63-1, June 17, 1963.

13

McDonnell's Project Mercury contract was terminated; McDonnell had already essentially concluded its Mercury activities and spacecraft 15-B had been delivered to Cape Canaveral. A termination meeting held at the Manned Spacecraft Center on June 14 settled the disposition of Mercury property and personnel. McDonnell was to screen all Mercury property for possible use in the Gemini program; any property McDonnell claimed would be transferred to Gemini by authority of the contracting officer at St. Louis or the Cape. McDonnell was directed to furnish Gemini Project Office with a list of key Mercury personnel who might be reassigned to Gemini.

Consolidated Activity Report, June 16–July 20, 1963, p. 38; Procurement and Contracts Division Consolidated Activity Report, June 17–July 22, 1963.

13

Rocketdyne completed its initial design of the 25-pound thrust chamber assembly (TCA) for both the reentry control system (RCS) and orbit attitude and maneuver system. Less than a month later, Rocketdyne recommended an entirely new design, which McDonnell approved on July 5. The redesigned TCA was planned for installation in spacecraft Nos. 5 and up. Meanwhile, however, Rocketdyne had established a thrust chamber working group to improve TCA performance. This group designed, built, and successfully tested in pulse operation two 25-pound RCS thrusters much more quickly than Rocketdyne had anticipated; thus the new design configuration was incorporated in the manufacturing plan for spacecraft Nos. 2 and up. The design of all TCAs, 25-, 85-, and 100-pound, were now identical. In reporting these developments, Gemini Project Office attributed the success of the new design to relaxed test requirements rather than to any breakthrough in design or material. In addition to reduced oxidizer-to-fuel ratios and less required firing time, thrust performance requirements were also lowered to 22.5 pounds for the 25-pound thrusters, 77.5 for the 85-pound thrusters, and 91.2 for the 100-pound thrusters.

Weekly Activity Report, June 16–22, 1963, p. 2; Consolidated Activity Report, June 16–July 20, 1963, p. 90; Quarterly Status Report No. 6, pp. 29–31; "Gemini Propulsion by Rocketdyne," pp. 6–7.

13

Manned Spacecraft Center–Atlantic Missile Range Operations Office reported that the malfunction detection system would be flown on Titan II launches N-24, N-25, N-29, N-31, and N-32. The first launch in this so-called "piggyback program" was scheduled for June 21. All preparations for this flight, including

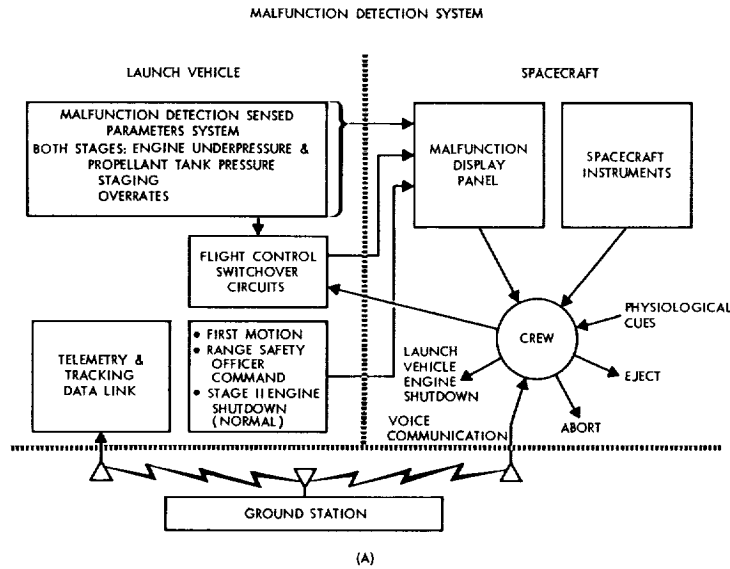
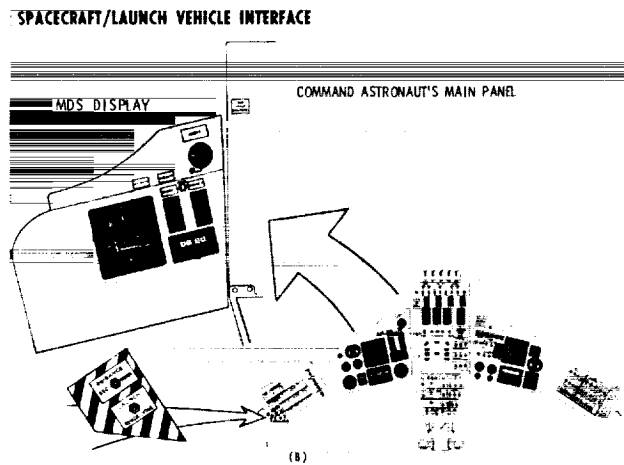

Figure 53.—(A) Malfunction detection system (MDS) block diagram; (B) MDS display on Gemini spacecraft instrument panel. (Martin Photos 8B-67547 and 8B-65781, undated.)



installation and checkout of all malfunction detection system components, were reported complete at a Titan II coordination meeting on June 14.

Memo, Pendley to Chief, FOD, Subj: Titan II Coordination Meeting of June 14, 1963, June 17, 1963; Consolidated Activity Report, May 19-June 15, 1963, p. 27.

The definitive contract for the Gemini space suit was signed with the David Clark Company. Negotiations had been completed May 28. The estimated cost was \$788,594.80, with fixed fee of \$41,000 for a total cost-plus-fixed-fee contract of \$829,594.80.

Consolidated Activity Report, May 19-June 15, 1963, pp. 38, 43.

1963
June

1963
June
15

Gemini Project Office (GPO) reported that the first manned Gemini mission would be three orbits. Whether so short a mission would allow time to perform the rendezvous experiment called for by the original mission plan remained in doubt, although Flight Operations Division's Rendezvous Analysis Branch had decided during the week of June 2 that a three-orbit mission was long enough to conduct a useful experiment. GPO had directed McDonnell to study the problem.

Weekly Activity Report, June 2-8, 1963, p. 2; Consolidated Activity Report, May 19-June 15, 1963, p. 72.

17

AiResearch installed the environmental control system (ECS) developmental test unit in a boilerplate spacecraft and began system development testing. Tests were conducted with gaseous rather than cryogenic oxygen until cryogenic tanks became available. AiResearch system development tests ended in September. Early in June, AiResearch shipped an ECS unit to McDonnell, where it was installed in boilerplate spacecraft No. 2 for manned testing which began July 11.

Weekly Activity Report, June 16-22, 1963, p. 2; Consolidated Activity Report, June 16-July 20, 1963, pp. 89-90; Quarterly Status Reports: No. 5, p. 16; No. 6, p. 22; No. 7, p. 35.

18

A flight evaluation test was conducted on the prototype recovery beacon of the Gemini spacecraft in Galveston Bay. A boilerplate spacecraft was placed in the Bay, and ranging runs were flown on the beacon by airplanes equipped with receivers. The maximum receiving range at 10,000-foot altitude was 123 miles.

Quarterly Status Report No. 6, p. 56.

19

The Cape Gemini/Agna Test Integration Working Group met to define "Plan X" test procedures and responsibilities. The purpose of Plan X was to verify the Gemini spacecraft's ability to command the Agna target vehicle both by radio and hardline; to exercise all command, data, and communication links between the spacecraft, target vehicle, and mission control in all practical combinations, first with the two vehicles about six feet apart, then with the vehicles docked and latched but not rigidized; and to familiarize the astronauts with operating the spacecraft/target vehicle combination in a simulated rendezvous mission. Site of the test was to be the Merritt Island Launch Area Radar Range Boresight Tower ("Timber Tower"), a 65×25×50-foot wooden structure.

Minutes, Cape Gemini/Agna Test Integration Working Group Meeting, June 19, 1963, with attached "General Description of Gemini/Agna RF Compatibility and Functional Compatibility Test on the Merritt Island Radar Range (Plan X)"; Lockheed Agna Monthly Report, June 1963, p. 2-2; Aerospace Final Report, p. III.F-4.

20

Sled test No. 2, the first dynamic dual-ejection test of the Gemini escape system, was run at China Lake. Both seats ejected and all systems functioned properly. The test was scheduled to be rerun, however, because the sled failed to attain high enough velocity. The purpose of sled tests in the ejection seat development program was to simulate various high-altitude abort situations. Sled test No. 3 was successfully run on August 9. Further tests were delayed while the ejection

1963
June

system was being redesigned. A modified egress kit was tested in two dummy drops on December 12, with no problems indicated. Gemini Project Office directed McDonnell to proceed with plans for the next sled test. Developmental sled testing on the escape system, incorporating the redesigned egress kit and a soft survival pack, resumed on January 16, 1964, with test No. 4; all systems functioned normally. Test No. 5, the planned repetition of test No. 2, brought developmental sled testing to an end on February 7.

Weekly Activity Reports: Aug. 4-10, p. 2; Dec. 8-14, 1963, p. 1; Consolidated Activity Reports: June 16-July 20, 1963, p. 88; Dec. 22, 1963-Jan. 18, 1964, p. 18; Jan. 19-Feb. 15, 1964, p. 17; Quarterly Status Reports: No. 6, p. 41; No. 7, pp. 42, 44; No. 8, pp. 29-30.

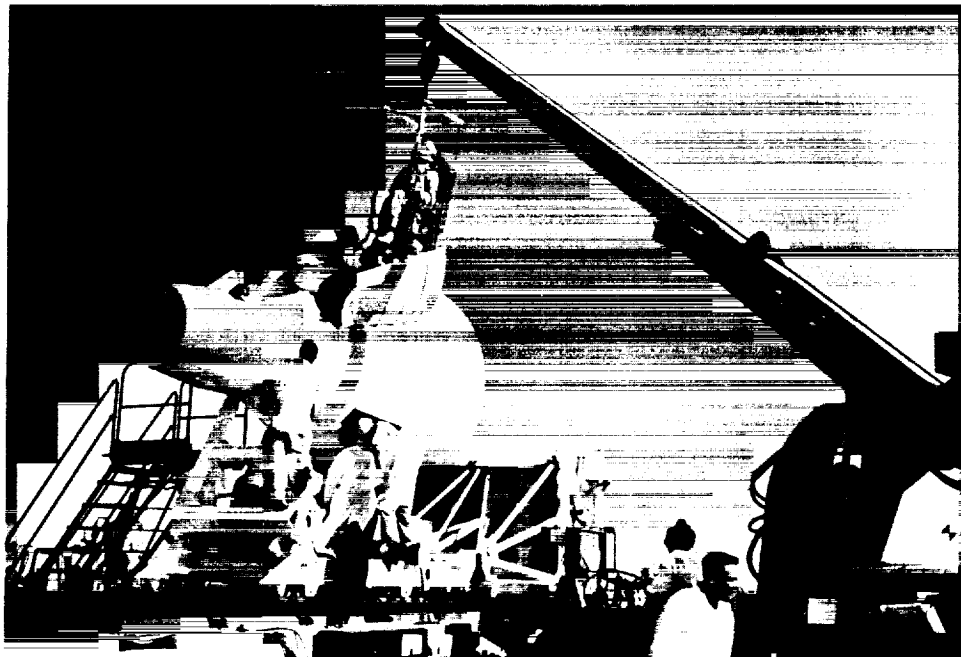

Figure 54.—Instrumented mannequin being lowered into a boilerplate Gemini spacecraft in preparation for a dynamic sled test of the Gemini ejection system. Notice the rocket motors at the rear of the sled that propelled it along the track. (NASA Photo 63-Gemini-60, released Sept. 30, 1963.)

A design review meeting was held at McDonnell to obtain comments and recommendations on the design of the Gemini spacecraft from experienced NASA personnel, including those who were active in the Mercury program. The meeting produced 76 requests for review, which NASA and McDonnell studied for possible changes in the spacecraft. A crew station mock-up review was held in conjunction with the design review.

20-21

Quarterly Status Report No. 6, pp. 6, 42.

Arnold Engineering Development Center conducted a retrorocket abort test. Although test objectives were met, failures in the nozzle assembly and cone of

24

1963
June

the retrorocket led to the redesign of the nozzle assembly. Another abort test was scheduled for October 1963 to verify the redesign.

Quarterly Status Report No. 6, p. 1.

24

North American began a series of five drop tests, using a boilerplate test vehicle, to qualify the parachute recovery system for the full-scale test vehicle in the Paraglider Landing System Program. The reoriented paraglider program had begun with two successful bomb-drop tests of the parachute recovery system on May 22 and June 3. The first boilerplate drop test saw both the main parachute and the boilerplate suffer minor damage; but boilerplate drops No. 2 (July 2), No. 3 (July 12), and No. 4 (July 18) were successful. A series of malfunctions in the fifth drop test on July 30 produced a complete failure of the recovery system, and the test vehicle was destroyed on impact. North American considered the objectives of the flight qualification program on the parachute system to have been met, despite this failure, and requested, since the boilerplate vehicle had been damaged beyond repair, that the parachute program be considered complete. Manned Spacecraft Center denied this request and, in Change Notice No. 3 to Contract NAS 9-1484, directed North American to support McDonnell in conducting two further drop tests. Wind tunnel tests on a 1/20-scale spacecraft model isolated the source of trouble, and the modified parachute recovery system was successfully tested with a new boilerplate test vehicle on November 12. Results from this test were confirmed by a second drop test on December 3, and the parachute recovery system for the full-scale test vehicle was judged fully qualified.

Weekly Activity Reports: June 2-8, p. 2; June 23-29, pp. 1-2; June 30-July 6, p. 2; Jul. 28-Aug. 3, pp. 1-2; Dec. 1-7, 1963, p. 1; Consolidated Activity Reports: June 16-July 20, pp. 87-88; Aug. 18-Sept. 21, p. 79; Oct. 20-Nov. 16, 1963, pp. 20-21; Quarterly Status Reports: No. 7, p. 32; No. 8, p. 25; Paraglider Landing System Program, Monthly Progress Reports: No. 1, June 15; No. 2, July 19; No. 3, Aug. 15; No. 4, Sept. 13; No. 6, Nov. 15; No. 7, Dec. 13, 1963; No. 8, Jan. 13, 1964.

25

Martin-Baltimore received the stage II fuel tank for Gemini launch vehicle 2 from Martin-Denver. This was a new tank, replacing a tank rejected for heat treatment cracks. Stage II oxidizer tank and stage I fuel and oxidizer tanks were received July 12 after a roll-out inspection at Martin-Denver July 1-3.

Gemini Program Mission Report for GT-2, Gemini 2, February 1965, p. 12-9; Aerospace Final Report, p. II.G-3; Gemini-Titan II Air Force Launch Vehicle, p. D-3.

27

Charles W. Mathews, Acting Manager of Gemini Project Office, reported to the Gemini Management Panel that the launching azimuth of the first Gemini mission had been changed from 90 to 72.5 degrees (the same as the Mercury orbital launches) to obtain better tracking network coverage. The spacecraft would be a complete production shell, including shingles and heatshield, equipped with a simulated computer, inertial measuring unit, and environmental control system in the reentry module. Simulated equipment would also be carried in the adapter section. The spacecraft would carry instruments to record pressures, vibrations, temperatures, and accelerations.

Minutes of Project Gemini Management Panel Meeting held at Martin-Baltimore, June 27, 1963.

At a meeting on spacecraft operations, McDonnell presented a "scrub" recycle schedule as part of a continuing investigation of the capability of a delayed Gemini launch to meet successive launch windows during rendezvous missions. With no change in either existing aerospace ground equipment or the spacecraft, the recycle time was 48 hours (an earlier estimate had been 24½ hours) for a trouble-free recycle. Gemini Project Office wanted the recycle time reduced to 24 hours and ultimately to something less than 19 hours to meet successive launch windows, possibly by replacing fuel cells with batteries for rendezvous missions only.

1963
June
28

Abstract of Meeting on Spacecraft Operations, July 5, 1963.

McDonnell began the first phase of Spacecraft Systems Tests (SST) on the instrumentation pallets to be installed in spacecraft No. 1. Numerous troubles brought a halt to SST on July 21 for two weeks of corrective action, including the return of one telemetry transmitter and the C-band beacon to the vendors for out-of-specification performance. Phase I of SST resumed August 5 and was completed well within test specifications August 21.

July
5

Weekly Activity Reports: July 21-27, p. 3; Aug. 4-10, 1963, p. 1; Quarterly Status Report No. 6, p. 85; Mission Report for GT-1, p. 12-21.

Figure 55.—The reentry control system unit for Gemini spacecraft No. 1 at the McDonnell plant. (NASA Photo #124, June 1963.)

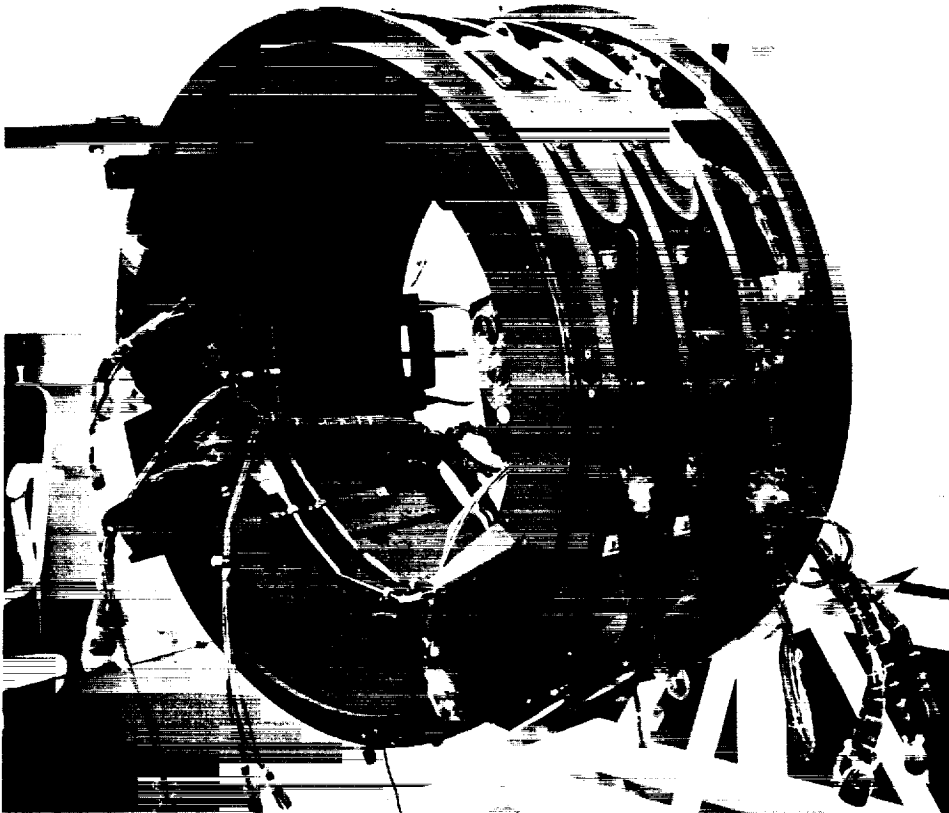

PROJECT GEMINI: A CHRONOLOGY

1963
July
5

The first engineering prototype inertial guidance system underwent integration and compatibility testing with a complete guidance and control system at McDonnell. All spacecraft wiring was found to be compatible with the computer, and the component operated with complete accuracy.

Quarterly Status Report No. 6, p. 35.

8

McDonnell warned Gemini Project Office that the capacity of the spacecraft computer was in danger of being exceeded. The original function of the computer had been limited to providing rendezvous and reentry guidance. Other functions were subsequently added, and the computer's spare capacity no longer appeared adequate to handle all of them. McDonnell requested an immediate review of computer requirements. In the meantime, it advised International Business Machines to delete one of the added functions, orbital navigation, from computers for spacecraft Nos. 2 and 3.

Message, Lindley to MSC, Attn: Charles W. Mathews, July 8, 1963.

9

The Gemini Phase I Centrifuge Program began at Naval Air Development Center, using the Aviation Medical Acceleration Laboratory centrifuge equipped to simulate the command pilot's position in the Gemini spacecraft. The program had two parts: an engineering evaluation of command pilot controls and displays required for the launch and reentry phases of the Gemini mission, including evaluation of prototype Gemini seat contours, pressure suit

Figure 56.—Dr. Howard A. Minners observes Astronaut Donald K. Slayton being readied for a run in the centrifuge at Aviation Medical Acceleration Laboratory, Johnsville, Pennsylvania. (NASA Photo 8-63-11195, July 1963.)



operation under acceleration, and the restraint system; and pilot familiarization with Gemini launch, reentry, and selected abort reentry acceleration profiles. The engineering evaluation was completed August 2. Pilot familiarization was conducted between July 16 and August 17. The participating astronauts were generally satisfied with the design and operation of displays and controls, though they recommended some minor operational changes. They were able to cope with the reentry tasks without undue difficulty, even under the high acceleration of extreme abort conditions.

1963
July

Consolidated Activity Reports: June 16–July 20, p. 2; July 21–Aug. 17, 1963, p. 22; Quarterly Status Report No. 6, pp. 77–78; interview, James B. Thomas, Houston, Sept. 13, 1967.

During evaluation of the G2C Gemini pressure suit in the engineering mock-up of the Gemini spacecraft at McDonnell, the suit torso was found to have been stretched out of shape, making it an unsatisfactory fit. David Clark Company had delivered the suit to McDonnell earlier in July. Evaluation in the mock-up also revealed that the helmet visor guard, by increasing the height of the helmet, compounded the problem of interference between the helmet and the spacecraft hatch. After preliminary evaluation, McDonnell returned the suit to David Clark with instructions to modify the helmet design to eliminate the fixed visor guard and to correct the torso fit problem. Final evaluation and start of production was delayed for about 6 weeks while the prototype suit was being reworked.

9

Quarterly Status Report No. 6, pp. 23–24, 42–43.

Walter C. Williams, Deputy Director for Mission Requirements and Flight Operations, Manned Spacecraft Center (MSC), and NASA Director of Flight Operations, wrote to Major General Leighton I. Davis, DOD Representative for Project Gemini Operations, summarizing the range safety problems inherent in the Gemini program which had been identified jointly by representatives of Range Safety Office, MSC, and contractors. The major unresolved problems concerned the effects of a catastrophic failure of the launch vehicle. In September Aerojet-General began a test program comparing cryogenic and hypergolic propellants, which showed that hypergolic propellants burn rather than explode if tanks rupture.

11

Letter, Williams to Davis, July 11, 1963; Abstract of Meeting on Gemini Launch Vehicle, July 18, 1963; interviews, Lou Wilson and Ray C. Stiff, Sacramento, June 30, 1966.

Gemini Project Office (GPO) completed a test program on the centrifuge at Ames Research Center to evaluate the effects on pilot performance of longitudinal oscillations (POGO) of the Gemini launch vehicle. When subjected to oscillatory g -loads ranging from 0 to $\pm 3g$ superimposed on a steady-state load of $3.5g$, pilot perception and performance decreased markedly above $\pm 0.25g$. Primary effects were impaired pilot vision, reduced eye scan rate, masked sensory perception and kinesthetic cues, and degraded speech. GPO reconfirmed the need to reduce POGO to a maximum of $0.25g$.

12

Weekly Activity Report, July 28–Aug. 3, 1963, pp. 2–3; Quarterly Status Report No. 6, p. 78; memo, Adm. Walter F. Boone to Seamans, Subj: August 1, 1963, Meeting on the Gemini Launch Vehicle Specifications, Aug. 2, 1963.

1963
July
12

Acting Manager Charles W. Mathews informed Manned Spacecraft Center (MSC) senior staff that Gemini Project Office was exploring the possibility of backing up the first Gemini flight with a payload consisting of a boilerplate reentry module and a production adapter. NASA Headquarters approved the additional flight article in August and requested that the mission be designated Gemini-Titan (GT) 1A. Estimated cost was \$1.5 to \$2 million. The boilerplate to be used was originally planned for flotation tests at MSC. It was manufactured by local contractors and modified by MSC after it was delivered in September. The adapter, identical in configuration and instrumentation to the one used for spacecraft No. 1, was to be shipped directly from McDonnell to Cape Canaveral, along with telemetry equipment and wiring harnesses to be installed in the boilerplate at the Cape. The GT-1A mission, if it were flown, would be identical to GT-1, but it would be flown only if GT-1 failed to achieve its objectives. Boilerplate flight article 1A left for the Cape on December 13.

Message, Mathews to Dineen, Sept. 6, 1963; MSC Minutes of Senior Staff Meetings: July 12, p. 6; Aug. 9, p. 4; Sept. 13, 1963, p. 5; Weekly Activity Reports: July 28-Aug. 3, p. 3; Dec. 8-14, 1963, p. 1; Quarterly Status Reports: No. 6, pp. 1, 3, 89; No. 7, p. 3; Minutes of GPO Staff Meeting, Sept. 4, 1963.

- 15 Development tests of the Agena Model 8247 main engine at Arnold Engineering Development Center ended when the latch-type gas generator valve failed in testing, making an emergency shutdown of the engine necessary. The wrong choice of emergency shutdown procedures caused turbine overspeed and total failure of the engine's turbine pump assembly. As a result of this failure, the valve was redesigned. Because success of the new design was doubtful, a parallel program was initiated to design and develop an alternative valve configuration, solenoid-operated rather than latch-type. Intensive development testing followed; and in a meeting at Bell Aerosystems on November 15, the solenoid type was selected for use in the first flight system of the Agena target vehicle. The new valve allowed significant reductions in engine complexity and increased reliability, but the development effort imposed a serious delay in Preliminary Flight Rating Tests, which had been scheduled to begin in September 1963.

Weekly Activity Report, Aug. 4-10, 1963, p. 2; Consolidated Activity Report, Nov. 17-Dec. 21, 1963, p. 21; Quarterly Status Reports: No. 6, p. 73; No. 7, p. 69; Lockheed Agena Monthly Reports: April, p. 2-6; July, pp. 2-1, 2-2; August 1963, p. 2-1.

- 18 In support of the Paraglider Landing System Program, Ames Research Center began wind tunnel tests of a half-scale paraglider test vehicle. Principle objectives of these tests were to obtain data on the longitudinal aerodynamic characteristics, lateral aerodynamic stability characteristics, and static deployment characteristics of the new low-lobe wing which North American and NASA had jointly agreed on. The new configuration was expected to present lateral stability problems. This series of tests ended August 8.

Consolidated Activity Report, June 16-July 20, 1963, p. 85; Paraglider Landing System Program, Monthly Progress Reports: No. 3, Aug. 15; No. 4, Sept. 13, 1963; "Paraglider Final Report," pp. 155-157, 276-277.

- 20 Gemini Project Office reported that the fuel cell development had slipped, although the amount of slippage had not been completely estimated. Causes of

the slippage had been rejection of vendor parts, extension of vendor delivery schedules, and lack of early determination of production procedures.

1963
July

Consolidated Activity Report, June 16–July 20, 1963, p. 87.

Electronic-Electrical Interference (EEI) Tests of Gemini launch vehicle (GLV) 1 began in the vertical test facility at Martin-Baltimore, following a review by Air Force Space Systems Division and Aerospace of data from Subsystem Verification Tests. Purpose of EEI was to uncover any interference between GLV electrical and electronic systems. In the second EEI (August 2), five systems were found to produce unacceptable interference. Two systems still did not meet specification in the third EEI (August 10), but all interference problems were eliminated in the fourth (August 20). After modification of the flight control system, a fifth EEI revealed minor interference (September 3), all of which was cleared up in the final test on September 5. Problems were resolved by adding filters and grounds to aerospace ground equipment and airborne circuits. EEI tests were performed in conjunction with Combined Systems Tests, which began August 2.

31

Mission Report for GT-1, p. 12-7; *Gemini-Titan II Air Force Launch Vehicle*, p. D-2.

A Design Engineering Inspection of the full-scale test vehicle (FSTV), with associated wing and hardware, for the Paraglider Landing System Program was held at North American's Space and Information Systems Division. This was the first such inspection under the new paraglider contract, NAS 9-1484. Under this contract, the two FSTVs were to be used solely to develop systems and

August
1

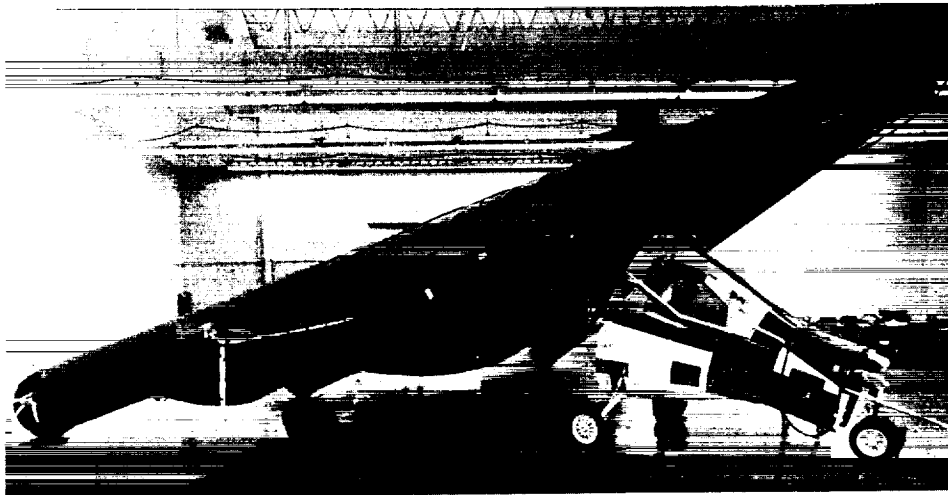

Figure 57.—The paraglider full-scale test vehicle in the Design Engineering Inspection briefing room at North American. (NASA Photo S-63-20931, undated.)

techniques for wing deployment. As originally conceived, they were also to provide the means of evaluating flight performance and control characteristics during glide; but this objective was dropped to minimize cost and to simplify

1963
August

vehicle systems. The inspection resulted in 30 requests for alterations, most of them mandatory.

Weekly Activity Report, July 28–Aug. 3, 1963, p. 3; Paraglider Landing System Program, Monthly Progress Report No. 4, Sept. 15, 1963; "Paraglider Final Report," p. 203.



Figure 58.—Astronauts after a training session in the desert near Stead Air Force Base, Nevada. Front row, left to right: Frank Borman, James A. Lovell, Jr., John W. Young, Charles Conrad, Jr., James A. McDivitt, Edward H. White II. Back row, left to right: Raymond G. Zedekar (Astronaut Training Officer), Thomas P. Stafford, Donald K. Slayton, Neil A. Armstrong, and Elliot M. Sec, Jr. (NASA Photo No. 63–Astronauts–135, released Aug. 16, 1963.)

- 5 The new flight crew members and two of the Mercury astronauts began a five-day desert survival course at Stead Air Force Base, Nevada. The course, oriented toward Gemini missions, was divided into three phases: (1) one and one-half days of academic presentations on characteristics of world desert areas and survival techniques; (2) one day of field demonstrations on use and care of survival equipment and use of the parachute in construction of clothing, shelters, and signals; and (3) two days of remote site training, when two-man teams were left alone in the desert to apply what they had learned from the academic and demonstration phases of the program.

Consolidated Activity Report, July 21–Aug. 17, 1963, p. 21.

- 8 Qualification testing of the Gemini parachute recovery system resumed over the Salton Sea Range, California, following a month's delay occasioned by resolving the parachute tucking problem. This test, the sixth in the qualification series, and the seventh (August 20) differed from the first five only in

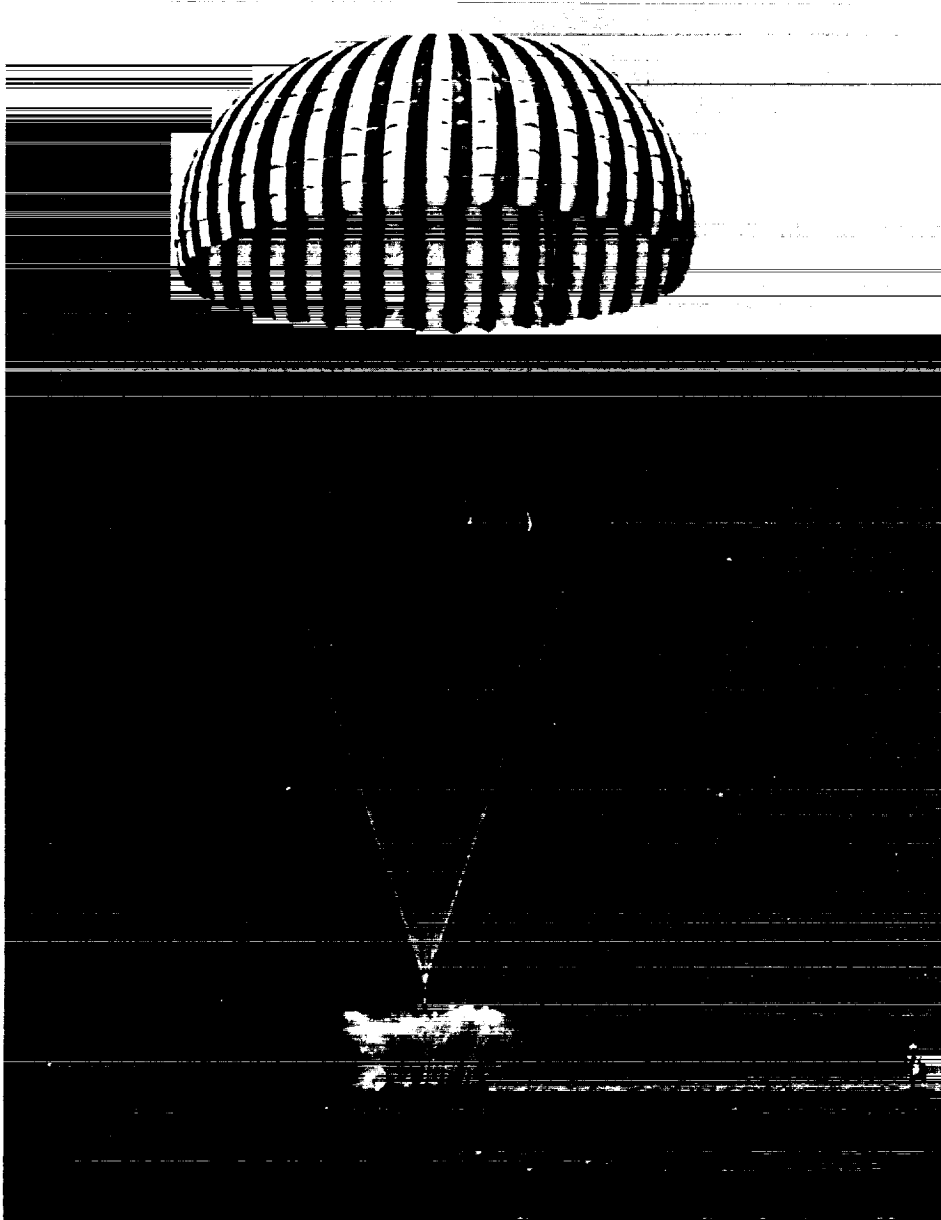

Figure 59.—Water impact test of the Gemini parachute recovery system in the Salton Sea, California. (Northrop Ventura Photo 0748-65-33328, undated.)

being water-impact rather than land-impact tests. They successfully demonstrated water-impact accelerations low enough to make water landing safe. Further qualification testing was suspended on September 3 by the decision to incorporate a high-altitude stabilization parachute in the recovery system.

Weekly Activity Reports : Aug. 4-10, p. 1 ; Aug. 18-24, p. 2 ; Sept. 8-14, 1963, p. 1 ;
Quarterly Status Reports : No. 6, p. 17 ; No. 7, p. 31.

*1963
August*

1963
August
9

Representatives of Manned Spacecraft Center (MSC), Arnold Engineering Development Center, McDonnell, and Thiokol met to analyze problems in the retrorocket abort system. Several components, including retrorocket nozzle exit cones and mounting structure, had failed in recent tests at Arnold. The primary cause of failure was a deficiency in the design for joining and retaining the retrorocket nozzle throat and exit cones. MSC and McDonnell decided to terminate development testing of the current nozzle assembly and initiate a redesign effort. Thiokol ran preliminary tests on the redesigned nozzle assembly on September 18-20. Full-scale tests at Arnold on October 4 then verified the structural integrity of the redesigned assembly, which operated without malfunction.

Weekly Activity Reports: July 21-27, pp. 2-3; Sept. 29-Oct. 5, 1963, p. 3; Quarterly Status Report No. 7, p. 10; Abstract of Meeting on Retrorocket Failure Analysis, Aug. 13, 1963.

- 20 Rocketdyne began a series of tests to verify its new thrust chamber assembly (TCA) design for the reentry control system (RCS) and the orbit attitude and maneuver system (OAMS). The test plan called for each type TCA, 25-pound RCS, 25-, 85-, and 100-pound OAMS, to be tested to mission duty cycle, steady-state life, limited environmental exposure, and performance. Rocketdyne submitted its design verification test schedule to McDonnell and Gemini Project Office on August 27, with seven of the 16 tests already completed. The remaining nine tests were to be finished by September 10. This proved an optimistic estimate; design verification testing was not completed until October.

Weekly Activity Report, Sept. 8-14, 1963, pp. 2-3; Quarterly Status Reports: No. 6, pp. 31-33; No. 7, pp. 15-19.

- 21 Titan II development flight N-24 was launched from the Atlantic Missile Range. This was the first of five flight tests in the Gemini malfunction detection system (MDS) piggyback series. All MDS parameters were lost 81 seconds after liftoff because of a short circuit in the MDS. Operation in the second flight (N-25 on November 1) was normal except for two minor instrumentation problems. Three more test flights (N-29 on December 12, 1963; N-31 on January 15, 1964; and N-33 on March 23, 1964) verified the performance of the Gemini MDS under actual conditions of flight environment and engine operation.

Memos, Pendley to Chief, FOD, Subj: N-24 Malfunction Detection System (MDS) Titan II Piggyback Test, Sept. 5, 1963; Pendley to Asst. Dir., FOD, Subj: N-25 Titan II Piggyback Malfunction Detection System (MDS) Flight, Nov. 7, 1963; Pendley to Asst. Dir., FOD, Subj: Titan II Malfunction Detection System (MDS) Piggyback Mission No. N-29, Dec. 19, 1963; Weekly Activity Reports: Aug. 18-24, p. 2; Oct. 27-Nov. 2, p. 2; Dec. 8-14, 1963, p. 2; Mar. 29-Apr. 4, 1964, p. 2; Harris, *Gemini Launch Vehicle Chronology*, p. 40.

- 21 Manned Spacecraft Center released a work statement for the procurement of eight Atlas launch vehicles for the Gemini program. A defense purchase request followed on August 28 with an initial obligation of \$1.4 million and an estimated final cost of \$40 million. The Atlas, like the other launch vehicles used in the Gemini program, was procured through Air Force Space Systems Division.

Weekly Activity Report, Aug. 18-24, 1963, p. 2; Consolidated Activity Report, Aug. 18-Sept. 21, 1963, p. 34.

McDonnell reported that spacecraft No. 2 was roughly one month behind schedule, primarily because of late deliveries of onboard systems from the vendors. Critical items were orbit attitude and maneuver system, reentry control system, fuel cells, and cryogenic storage tanks. Several systems had failed to pass vibration qualification and required modification. The Development Engineering Inspection of the spacecraft was scheduled for October 1963, but further delays postponed it until February 12-13, 1964.

1963
August
24

Weekly Activity Report, Aug. 18-24, 1963, pp. 1-2; Quarterly Status Report No. 7, p. 1; Consolidated Activity Report, Jan. 14-Feb. 15, 1964, p. 18.

McDonnell completed the fabrication and assembly of spacecraft No. 1 with the mating of the spacecraft's major modules. Phase II of Spacecraft Systems Tests (SST) on the complete launch configuration, including adapter, began August 27. Tests alternated with final manufacturing cleanup over the next three weeks. Vibration testing was conducted September 17-20; Altitude Chamber Tests, September 21-23; and SST concluded September 30 with an Integrated Systems Test. The spacecraft passed its final roll-out inspection on October 1 and was shipped to Atlantic Missile Range October 4.

25

Weekly Activity Report, Sept. 1-7, 1963, p. 2; Quarterly Status Reports: No. 6, p. 85; No. 7, p. 1; Mission Report for GT-1, p. 12-21; Abstract of Meeting on Spacecraft No. 1 Roll-out Inspection, Oct. 7, 1963.

Gemini Project Office (GPO) reported that it was investigating the use of a parasail and landing rocket system to enable the Gemini spacecraft to make land landings. Major system components were the parasail, drogue parachute, retrorocket, control system, and landing rocket. Unlike the conventional parachute, the parasail was capable of controlled gliding and turning. Landing rockets, fired just before touchdown, reduced the spacecraft terminal rate of descent to between 8 and 11 feet per second. Research and development testing was being conducted by the Landing and Impact System Section of Systems Evaluation and Development Division at Manned Spacecraft Center, while McDonnell had just completed a limited study of the advantages and disadvantages, including time required, of incorporating the new landing system on the spacecraft. GPO briefed NASA Headquarters on the system September 6, when it was decided that no further action would be taken on the parasail.

31

Quarterly Status Report No. 6, pp. 21-22.

Gemini Project Office reported that systems testing of the orbit attitude and maneuver system (OAMS) and reentry control system (RCS) was scheduled to be resumed early in October. Systems tests had begun in August 1962 but had been brought to a halt by the unavailability of thrust chambers. Three categories of systems tests were planned: (1) Research and Development Tests, comprising gas calibrations, aerospace ground equipment, evaluation, surge pressure evaluations, pulse interactions, steady-state evaluations, and vacuum soak tests; (2) Design Information Tests, comprising extreme operating condition evaluations, a group of fill-drain-decontamination-storage tests, pulse performance, skin heating, expulsion efficiency, liquid calibration, manual regulation, and propellant gauging; and (3) Design Approval Tests, comprising acceleration testing, RCS mission duty cycle tests at ambient temperature, OAMS two-day mission duty cycle tests at ambient temperature, and OAMS

31

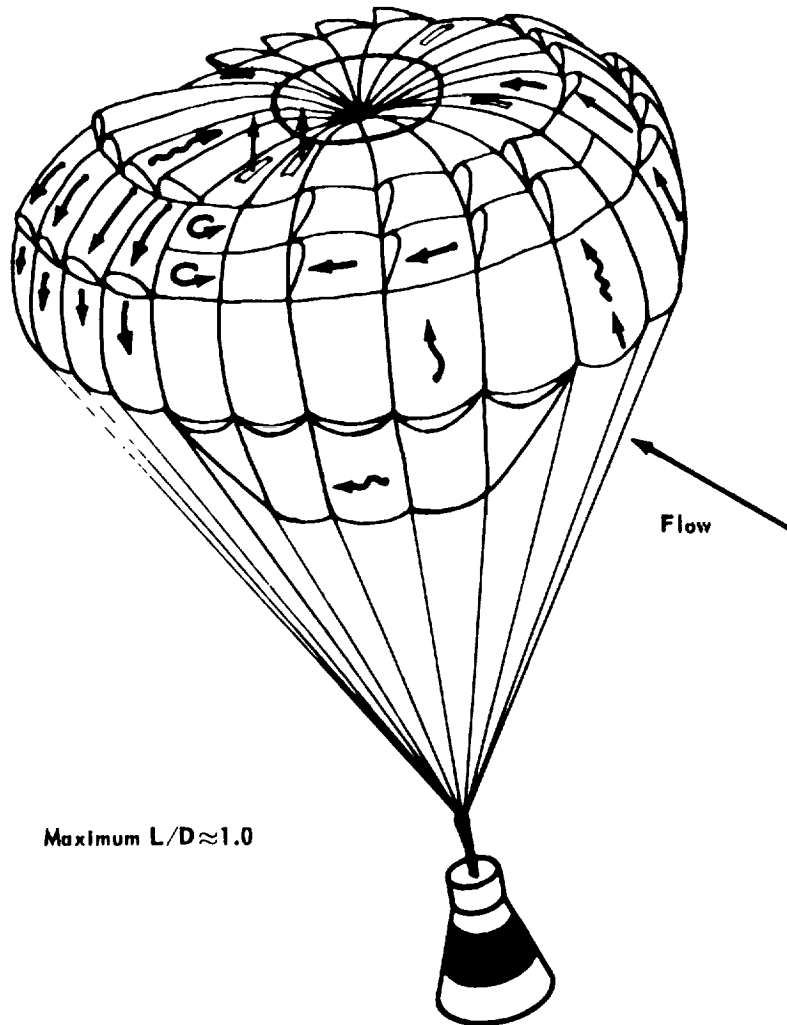

Figure 60.—Sketch of the parasail landing system proposed for the Gemini spacecraft. (NASA Photo S-64-481, undated.)

1963
August

14-day mission duty cycle tests at ambient temperature. Systems testing did not actually resume until May 1964.

Quarterly Status Reports: No. 6, p. 38; No. 9 for Period Ending May 31, 1964, p. 9.

31

Gemini Project Office reported that the first production computer was in its final factory testing phase and would be ready for inertial guidance system integration testing on September 6, 1963.

Quarterly Status Report No. 6, p. 26.

During
the
month

The Gemini Pyrotechnic Ad Hoc Committee submitted its final report. As a result of the spacecraft design review of June 20-21, Acting Manager Charles W. Mathews of Gemini Project Office (GPO) had requested Mercury Project Office (MPO) to organize an ad hoc committee to review the Gemini pyro-

technic systems, design, qualification, and functions. The committee was headed by Russell E. Clickner of MPO and included members from MPO, GPO, Technical Services Division, and Systems Evaluation and Development Division. The committee's findings resulted in significant modifications to pyrotechnic circuitry, redundancy, system design, and qualification testing.

1963
August

Gemini Pyrotechnic Ad Hoc Committee, Report to Gemini Project Manager, August 1963; memo, Chief, TSD, to PAO, Subj: Comment Draft of "Project Gemini Technology and Operations: A Chronology," May 31, 1967.

A Mission Planning Coordination Group was established at the request of the Gemini Project Office to review monthly activities in operations, network, guidance and control, and trajectories and orbits; and to ensure the coordination of various Manned Spacecraft Center elements actively concerned with Gemini mission planning. Its first meeting was scheduled for September 9 to discuss Gemini mission planning documentation, Gemini-Titan (GT) 1 mission plan, MISTRAM (missile tracking and measurement system) requirements and use of the J-1 computer, and mission objectives and tests for GT-2 and GT-3.

September
3

Memo, Kraft for Distribution, Subj: Formulation of Gemini Mission Planning Coordination Group, Sept. 3, 1963.

Gemini Project Office (GPO) suspended qualification testing of the parachute recovery system to permit incorporating a drogue parachute in the system as a means of stabilizing the spacecraft during the last phase of reentry, at altitudes between 50,000 and 10,000 feet. This function had originally been intended for the reentry control system (RCS), currently suffering from serious development problems. The revised design would also permit RCS propellants to be dumped before deploying the main recovery parachute. GPO outlined a three-phase drop test program to develop the drogue chute and qualify the revised recovery system. Phase I, scheduled for January and February 1964 and using boilerplate No. 5 as a test vehicle, would develop the technique of deploying the pilot parachute by the stabilization chute. The deployment sequence was planned to begin with deployment of the stabilization chute at 50,000 feet. At 10,600 feet, the astronaut would release the stabilization chute. A lanyard connecting the stabilization and pilot chutes would then deploy the pilot chute. Two and one-half seconds later, the rendezvous and recovery (R and R) section would separate from the spacecraft, allowing the main chute to deploy. Phase II of the drop test program, scheduled for March through August 1964 and using a parachute test vehicle (an instrumented weight bomb), would complete development of the stabilization chute. From June through October 1964, Phase III tests would qualify the recovery system, using static article No. 7, a boilerplate pressure vessel and heatshield equipped with production RCS and R and R sections. Since this program was not expected to be finished before the third Gemini mission, qualification of the existing system was to be completed with three more drops in February and March 1964. Static article No. 7 would serve as the test vehicle before being diverted to Phase III testing.

3

Weekly Activity Report, Sept. 8-14, 1963, p. 1; Consolidated Activity Report, Sept. 22-Oct. 19, 1963, p. 94; Quarterly Status Report No. 7, pp. 31-32; Abstract of Meeting on Parachute Landing System, Oct. 9, 1963.

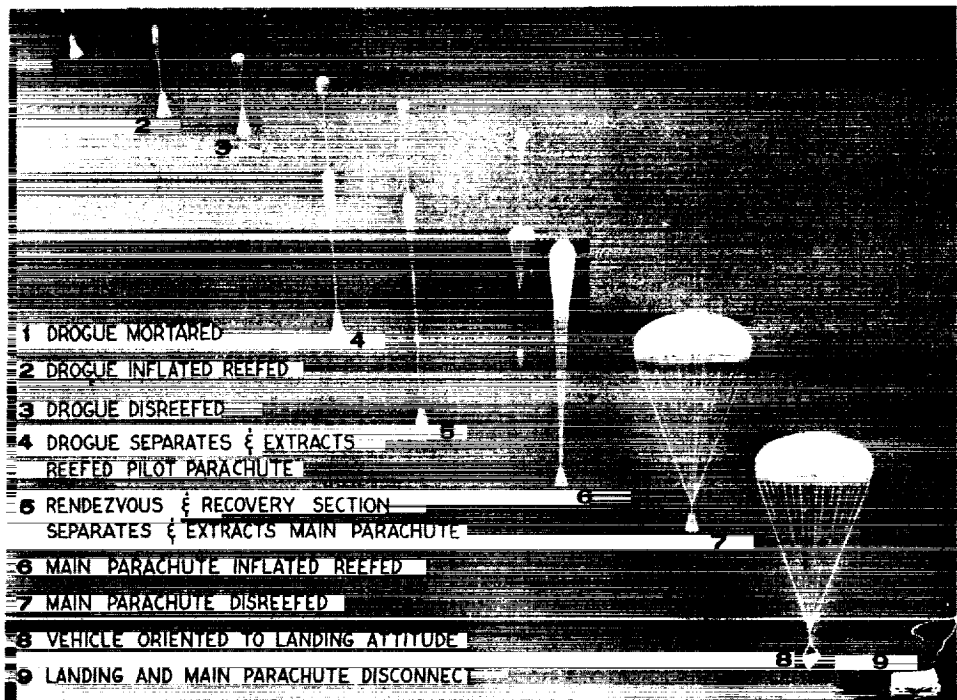

Figure 61.—The sequence of events in the operation of the Gemini parachute recovery system incorporating the drogue chute. (Northrop Ventura Photo 0748-94-38242, undated.)

1963
September
4

Representatives of Manned Spacecraft Center's Instrumentation and Electronics Systems Division and McDonnell met to coordinate the Gemini radar program. Gemini Project Office had requested an increased effort to put the rendezvous radar system in operational status.

Consolidated Activity Report, Aug. 18-Sept. 21, 1963, p. 59.

- 5 Lockheed's contract for the Gemini Agena target vehicle (GATV) was amended. As a result of the seven-and-one-half-month relaxation of the required launch date for the first GATV, Lockheed was directed to use the improved version of the standard Agena, the AD-62 block of vehicles, instead of AD-13. The AD-62 block originally included the multistart engine, subsequently slipped to the AD-71 block. Lockheed accordingly was directed in January 1964 to substitute the AD-71 for AD-62. The combined effect of these changes was to use up much of the seven-and-one-half-month leeway. The change to AD-62 caused a two-month slip, and changing to AD-71 added a five-week slip. With much of the contingency time gone, the Agena schedule was now tight, and further slippage threatened to cause launch delays.

Minutes of Project Gemini Management Panel Meeting held at SSD, Feb. 7, 1964, p. 8; Consolidated Activity Report, Feb. 16-Mar. 21, 1964, p. 21; Quarterly Status Report No. 6, p. 73; Lockheed Agena Monthly Reports: September, p. 2-6; October 1964, p. 3-1; January 1965, p. 3-7.

- 6 Department of Defense approved the Titan II Augmented Engine Improvement Program. On November 15, Aerojet-General received an Air Force

1963
September

contract to develop and test new engine components to correct weak and potentially dangerous problem areas of engine design. Aerojet-General had already initiated the development effort on September 30. The goal was to enhance engine reliability by a complete redesign rather than resort to piecemeal fixes as problems came up. While the primary goal was not achieved, the program did yield several side benefits, including the correction of several minor design deficiencies, the improvement of welding techniques, and the development of better assembly procedures.

Letters, Lt. Gen. Howell M. Estes, Jr., to Seamans, Subj: Titan II/Gemini Program Status Summary, Sept. 18, Oct. 18, 1963; "Statement of Work: Titan II Augmented Engine Improvement Program," Oct. 3, 1963; Harris, *Gemini Launch Vehicle Chronology*, p. 30.

The formal Combined Systems Acceptance Test (CSAT) of Gemini launch vehicle No. 1 was conducted in the vertical test facility at Martin-Baltimore. Two preliminary CSAT dry runs had been conducted on August 2 and 17, in conjunction with Electronic-Electrical Interference (EEI) Tests. A third CSAT with EEI monitoring had been run on September 3 to clarify checkout procedures and recheck EEI results. CSAT included a complete launch countdown, simulated engine start, liftoff, and flight through stage II engine shutdown, ending with the simulated injection of the spacecraft into Earth orbit. Both primary and secondary guidance and control combinations were tested. Martin engineers reviewed the test data collected by aerospace ground equipment recorders and telemetry and presented the vehicle for final acceptance to the Air Force Space Systems Division/Aerospace Vehicle Acceptance Team on September 11.

6

Mission Report for GT-1, p. 12-7; Aerospace *Final Report*, pp. II.F-1, II.F-2; *Gemini-Titan II Air Force Launch Vehicle*, p. D-2.

The 16 astronauts began training in water and land parachute landing techniques. This training was necessary because in low level abort (under 70,000 feet) the pilot would be ejected from the spacecraft and would descend by personnel parachute. A towed 24-foot diameter parasail carried the astronauts to altitudes as high as 400 feet before the towline was released and the astronaut glided to a landing.

8

Consolidated Activity Report, Aug. 18-Sept. 21, 1963, p. 47; *MSC Space News Roundup*, Sept. 18, 1963, pp. 1, 3.

Following up Gemini Project Office's request to bring the Gemini rendezvous radar system to operational status, Manned Spacecraft Center Instrumentation and Electronics System Division personnel met with Westinghouse at Baltimore to review the test program. Westinghouse had completed its radio frequency anechoic chamber test, but test anomalies could not be pinpointed to the radar system, since chamber reflections might have been responsible. An outdoor range test was planned to determine whether the chamber was suitable for testing the radar.

11-12

Consolidated Activity Report, Aug. 18-Sept. 21, 1963, p. 50.

The vehicle acceptance team for Gemini launch vehicle (GLV) 1 inspected the vehicle and reviewed its manufacturing and testing history, focusing on the

11-20

1963
September

results of the Combined Systems Acceptance Test (CSAT) of September 6. The team found GLV-1 to be unacceptable, primarily because of severely contaminated electrical connectors. In addition, the qualification of a number of major components had not been properly documented. Between September 21 and 29, Martin engineers inspected all of the 350 electrical connectors on GLV-1 for contamination and found 180 requiring cleaning or replacement. All electrical connectors on GLV-2 were also reinspected and cleaned or replaced as needed. This extensive inspection invalidated much previous testing, requiring subsystem tests and CSAT to be rerun. Preliminary CSAT was completed October 2, final CSAT October 4.

Mission Reports: for GT-1, p. 12-7; for GT-2, p. 12-10; Aerospace *Final Report*, p. II.G-3; *Gemini-Titan II Air Force Launch Vehicle*, p. D-2; Harris, *Gemini Launch Vehicle Chronology*, p. 28.

- 14 Gemini Project Office reported a delay of about three weeks in the battery qualification program. McDonnell had sent a team to investigate the problem of high porosity welds in titanium battery cases. Another problem had turned up with the batteries in prequalification vibration test. The batteries vibrated excessively, although they did not fail electrically; the vibration's amplification factor was apparently low enough to be remedied by potting.

Weekly Activity Report, Sept. 8-14, 1963, p. 2.

- 23 A technical development plan for Department of Defense experiments to be carried on Gemini missions was issued. The plan described 13 Air Force experiments and nine Navy experiments costing as estimated \$22 million. Manned Spacecraft Center reviewed the experiments for feasibility while the plan was being prepared, but their inclusion on Gemini flights was tentative, pending further technical definition of the experiments themselves and clarification of spacecraft weight and volume constraints.

Letters, McMillan to Seamans, Oct. 28, 1963; Seamans to McMillan, Dec. 23, 1963; memo, McMillan to Dir., Defense Research and Engineering, Subj: DOD/NASA Gemini Experiments, Technical Development Plan (TDP) for Program 631A, Oct. 14, 1963.

- 27 Electro-Mechanical Research successfully tested the compatibility of airborne and ground station PCM (pulse code modulated) telemetry equipment. The tests demonstrated that Gemini spacecraft and Agena telemeter and recorder formats were compatible with NASA ground stations.

Weekly Activity Report, Sept. 22-28, 1963, p. 1; Consolidated Activity Report, Sept. 22-Oct. 19, 1963, p. 93; Lockheed *Agena Monthly Report, September 1963*, p. 2-5.

- 27 A Development Engineering Inspection of the tow test vehicle (TTV), its associated wings, hardware, and mock-up, for the Paraglider Landing System Program was held at North American's Space and Information Systems Division. The TTVs (the contract called for two) were manned vehicles to be flown with the wing predeployed to evaluate flight performance and control with particular emphasis on the landing maneuvers. The inspection resulted in 33 requests for alteration, 24 of them mandatory.

Quarterly Status Report No. 7, p. 33; Paraglider Landing System Program, Monthly Progress Report No. 5, Oct. 16, 1963; "Paraglider Final Report," p. 276.

1963
September
27

North American stopped its effort to retrofit the full-scale test vehicle (FSTV) to Gemini prototype paraglider deployment hardware. The contract for the Paraglider Landing System Program had provided for North American to incorporate Gemini equipment, insofar as possible, in the FSTV as it became available—this was the so-called retrofit. The decision to stop work on retrofit was made at a conference between North American and NASA on September 26; retrofit was deleted as a contract requirement on November 7 by Change Notice No. 5 to Contract NAS 9-1484.

NAA, A Final Fee Settlement Proposal for Contract NAS 9-1484, pp. III-1, V-36.

Manned Spacecraft Center awarded its first incentive-type contract to Ling-Temco-Vought, Inc., Dallas, Texas, for the fabrication of a trainer to be used in the Gemini launch vehicle training program. The fixed-price-incentive-fee contract had a target cost of \$90,000, a target profit of \$9,000, and a ceiling of

30

Figure 62.—Diagram of the Gemini launch vehicle stage II engine. (Martin Photo 8B-66461, undated.)

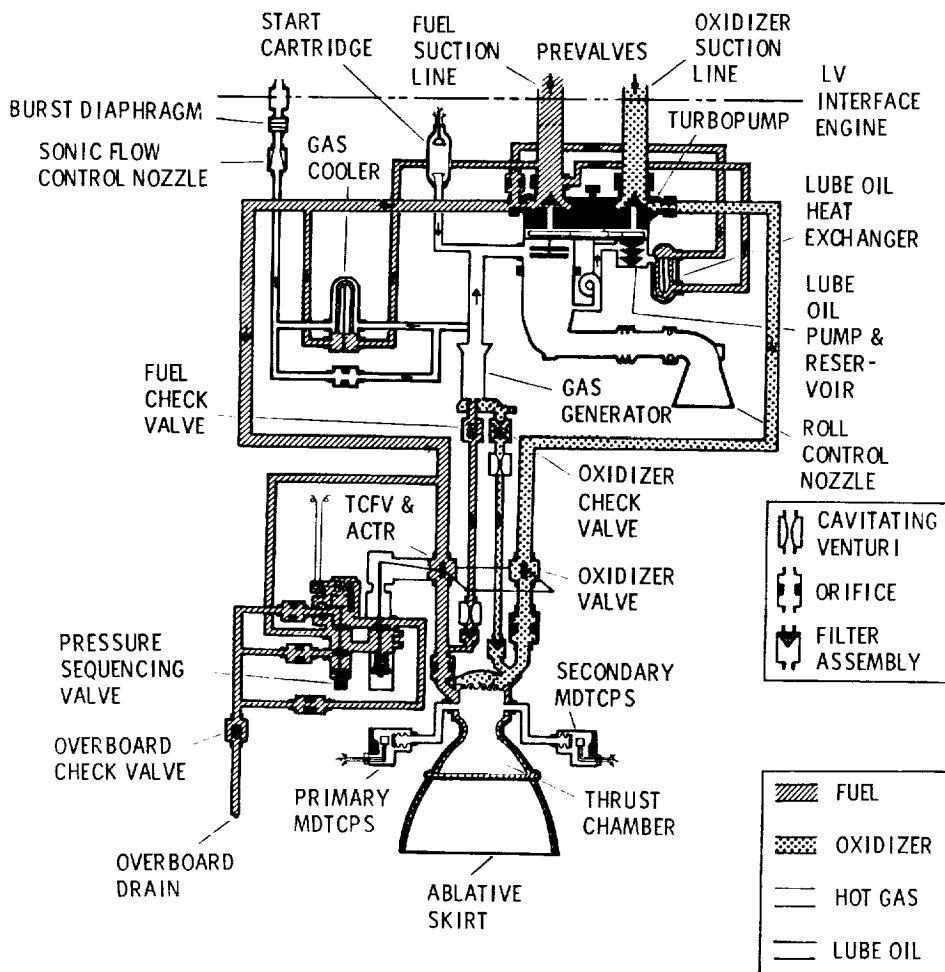

PROJECT GEMINI: A CHRONOLOGY

1963
September

\$105,000. The incentive was based on cost only and provided for an 80/20 sharing arrangement; that is, the contractor would pay from his profit 20 percent of all costs in excess of the target cost, or, alternatively, would receive 20 percent of all savings under the target cost. This meant that the contractor's profit would be zero after \$97,500 was spent, and would be minus if costs exceeded \$105,000.

Consolidated Activity Report, Sept. 22-Oct. 19, 1963, p. 40; Procurement and Contracts Division Report for Sept. 24-Oct. 18, 1963; memo, Bernhardt L. Dorman to Asst. Adm. for Policy Analysis, Subj: Gemini Program Chronology, July 20, 1967.

30

Air Force Space Systems Division contracted with Aerojet-General for a program to develop a backup for the injectors of the second stage engine of the Gemini launch vehicle. Titan II development flights had shown the stage II engine tended toward incipient combustion instability. The Gemini Stability Improvement Program, begun as a backup, became a program aimed at maximum probability of success on December 24, 1963. The 18-month program produced a completely redesigned stage II engine injector.

Letters, Estes to Seamans, Subj: Titan II/Gemini Program Status Summary, Oct. 8, Oct. 16, Nov. 29, Dec. 26, 1963; Harris, *Gemini Launch Vehicle Chronology*, p. 29.

October
1

Gemini Project Office (GPO) requested McDonnell to do a design study of the requirements and configuration necessary for using batteries instead of fuel cells in all spacecraft scheduled for two-day rendezvous missions. Personnel from GPO had visited General Electric to review the results of experiments

Figure 63(A).—Instrumentation pallet for Gemini spacecraft No. 1: left pallet. (NASA S-64-3069, undated.)

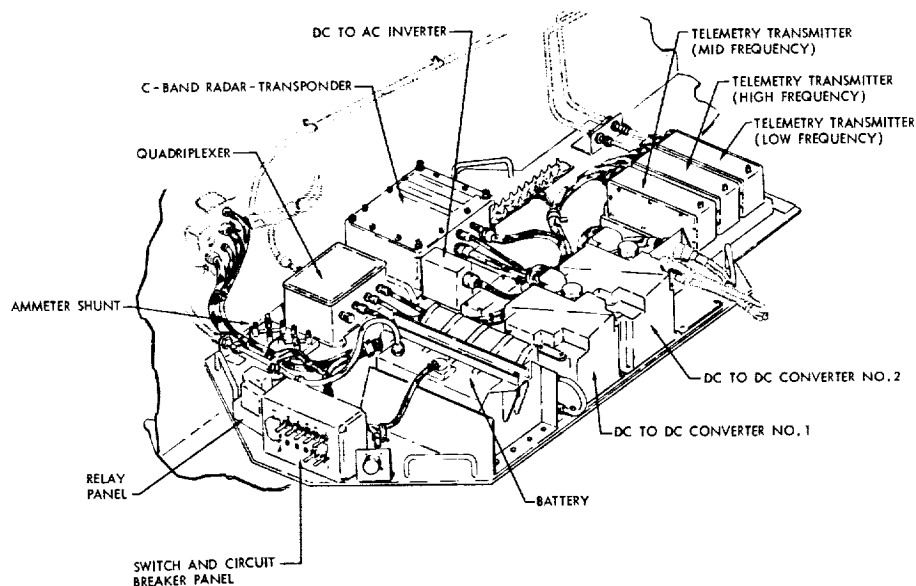

(A)

1963
October

conducted to determine the theoretical operating life of the fuel cells to power the Gemini spacecraft. Test results showed a life of about 600 hours, but changes in the spacecraft coolant system increased the fuel cell operating temperatures and reduced fuel cell life by about two-thirds. The theoretical life of the cells was between 150 and 250 hours; until some method of increasing the operating life of the fuel cell could be achieved, the development program would remain a problem.

Message, Mathews to Burke, Subj: Contract NAS 9-170, Power System Design Study, Oct. 1, 1963; Weekly Activity Report, Sept. 29-Oct. 5, 1963, pp. 2-3.

Gemini Project Office prepared an abstract of flight qualification requirements for experimental equipment to be carried on Gemini missions. The document presented a brief synopsis of the important environmental criteria which would affect the design, fabrication, and mounting of experimental equipment to be carried in the spacecraft.

1

Abstract of Flight Qualification Requirements for Experimental Equipment to be carried on Gemini Missions, prepared Oct. 1, 1963.

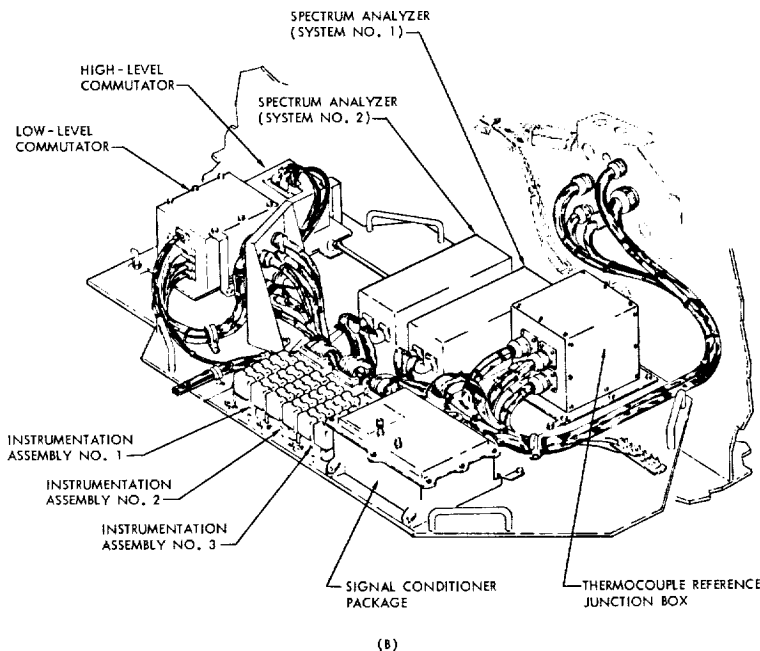

Figure 63(B).—Instrumentation pallet for Gemini spacecraft No. 1: right pallet. (NASA S-64-3066, undated.)

Gemini spacecraft No. 1 arrived at Atlantic Missile Range and was transferred to Hangar AF. After a receiving inspection (October 7) and Voltage Standing Wave Ratio Test (October 8), its instrument pallets were removed for laboratory test and checkout (October 9) while the spacecraft was being checked out, weighed, and balanced. Instrument pallets were reinstalled November 26. Individual and integrated communications, instrumentation, and environmental

4

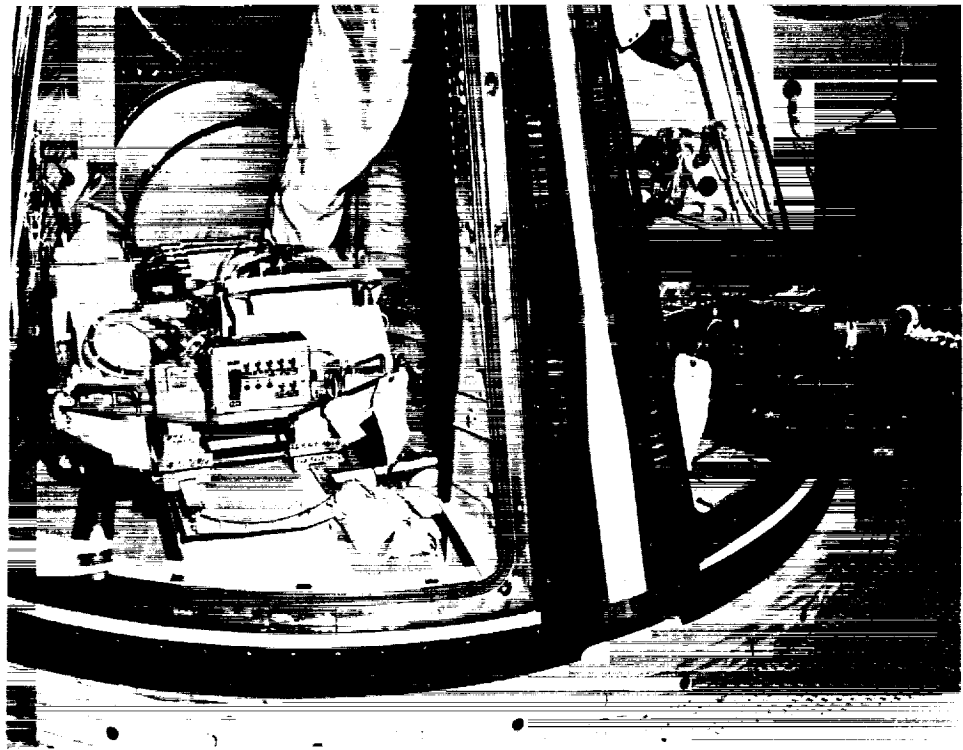

Figure 64.—Installation of right ballast seat and instrument pallet in Gemini spacecraft No. 1. (NASA-USAF Photo 63-13025, Dec. 7, 1963.)

1963
October
8

control systems tests were then performed. Final industrial area testing of the spacecraft concluded with a confidence level test on February 12, 1964.

Mission Report for GT-1, pp. 12-1, 12-22; Quarterly Status Report No. 7, p. 80.

Martin-Baltimore completed its evaluation of data from the second Combined Systems Acceptance Test of Gemini launch vehicle (GLV) 1, found it acceptable, and presented it to the GLV-1 vehicle acceptance team (VAT). VAT inspection resulted in the decision, on October 12, to ship GLV-1 to Atlantic Missile Range (AMR). Although the vehicle still lacked flight-qualified components, the VAT critique noted that having the GLV at AMR, even with non-flight equipment, would expedite the Gemini program by permitting early checkout of launch vehicle and complex compatibility and final acceptance of complex 19. GLV-1 was removed from the vertical test facility on October 12, tested for tank leaks, painted, weighed, inspected, and prepared for shipment. Air Force Space Systems Division formally accepted GLV-1 on October 25; the vehicle was airlifted to AMR the following day.

Mission Report for GT-1, p. 12-7; Aerospace *Final Report*, p. II.G-3; *Gemini-Titan II Air Force Launch Vehicle*, pp. D-2, D-3; Harris, *Gemini Launch Vehicle Chronology*, p. 29.

14

North American completed work on the first full-scale prototype paraglider wing for the Paraglider Landing System Program and shipped it to Ames Re-

1963
October

search Center for wind tunnel tests. Test objectives were to determine the longitudinal aerodynamic characteristics, structural deflections, and spreader bar buckling limits of the full-scale wing. Testing ended October 28 but yielded very limited data. As a result, a second test of the full-scale wing was conducted from December 4 to December 9; this time all test objectives were met.

Weekly Activity Reports: Oct. 27–Nov. 2, p. 1; Dec. 1–7, 1963, pp. 1–2; Quarterly Status Report No. 7, p. 68; Paraglider Landing System Program, Monthly Progress Reports: No. 6, Nov. 15, 1963; No. 8, Jan. 13, 1964; "Paraglider Final Report," pp. 164–171.

The Mission Planning Coordination Group discussed the feasibility of rendezvous at first apogee, as proposed by Richard R. Carley of the Gemini Project Office. The group concluded that developing the ability to rendezvous at first apogee was a test objective and that capability for performing the maneuver should be provided in the mission plan for all rendezvous flights.

14

Memo, Kraft to Distribution, Subj: Second Meeting of Mission Planning Coordination Group, Oct. 22, 1963; interview, Edwin E. Aldrin, Jr., Houston, June 20, 1967.

Personnel from Air Force Space Systems Division (SSD), Air Force Ballistic Systems Division (BSD), and Titan II contractors met in Los Angeles to reconsider flying Gemini launch vehicle (GLV) fixes on Titan II development flights. BSD, which was responsible for the weapon system development program, had halted the installation of GLV fixes on the Titan II flights because of the limited number of flights remaining to qualify the missile. General Bernard A. Schriever, Commander of Air Force Systems Command (of which BSD and SSD were subordinate divisions), intervened in support of an active program to clean up launch vehicle problem areas. The incorporation of GLV fixes on Titan II flights resumed on November 1 with the flight of Titan II N-25.

15

Minutes of Project Gemini Management Panel Meeting held at Patrick AFB, Fla., Nov. 13, 1963; interviews: Dineen, Huntington Beach, Calif., May 15, 1967; Maj. Gen. Ben I. Funk, Sunnyvale, Calif., May 12, 1967.

Fourteen new astronauts were introduced by officials of the Manned Spacecraft Center (MSC) at a press conference in Houston, bringing to 30 the total number assigned to NASA's astronaut training center. The new group of astronauts was composed of seven volunteers from the Air Force, four from the Navy, one from the Marine Corps, and two civilians. From the Air Force: Major Edwin E. Aldrin, Jr.; Captains William A. Anders, Donn F. Eisele, Charles A. Bassett II, Theodore C. Freeman, David R. Scott, and Michael Collins. The Navy volunteers were Lieutenant Commander Richard F. Gordon, Jr., and Lieutenants Eugene A. Cernan, Alan L. Bean, and Roger B. Chaffee; the Marine was Captain Clifton C. Williams, Jr. The two civilians were R. Walter Cunningham and Russell L. Schweickart. The group was selected from approximately 500 military and 225 civilian applicants who had responded to NASA's request for volunteers early in May 1963. The new astronauts reported to MSC to begin training February 2, 1964.

18

MSC *Space News Roundup*: June 12, pp. 1–2; Oct. 30, 1963, pp. 1–4; MSC News Release 64–24, Feb. 5, 1964.

Rocketdyne test-fired an orbit attitude and maneuver system (OAMS) 85-pound thruster to a new mission duty cycle requiring 550 seconds of normal

21

1963
October

operation and 750 seconds before catastrophic failure. In noting McDonnell's reevaluation of the OAMS mission duty cycles, which imposed increased life requirements on OAMS thrust chamber assemblies (TCA), Gemini Project Office pointed out that this change compounded the TCA problem: the current (and briefer) mission duty cycles had yet to be demonstrated under specification conditions on the 25-pound and 100-pound TCAs. During the next two months, Rocketdyne stopped testing and concentrated on analyzing the performance characteristics of small ablative rocket engines, while McDonnell completed revising of duty cycles. Representatives of NASA, McDonnell, and Rocketdyne met in January 1964 to clarify the new life requirements for OAMS engines, which were significantly higher: required life of the 25-pound OAMS thruster in pulse operation was raised from 232.5 seconds to 557 seconds; that of the 85- and 100-pound thrusters, from 288.5 to 757 seconds.

Weekly Activity Report, Oct. 20-26, 1963, p. 2; Quarterly Status Report No. 7, pp. 17, 27-28; "Gemini Propulsion by Rocketdyne," p. 6.

- 25 North American finished modifying the Advanced Paraglider Trainer to a full-scale tow test vehicle (TTV), as required by the Paraglider Landing System Program. The vehicle was then shipped to Edwards Air Force Base, where ground tow tests began on December 28. Preliminary ground tow testing was completed on January 14, 1964. The second TTV was completed on January 28 and shipped to Edwards on February 14. Further ground tow tests were conducted through June. Installation of flightworthy control system hardware began in April.

NAA, A Final Fee Settlement Proposal for Contract NAS 9-1484, p. V-32; Paraglider Landing System Program, Monthly Progress Reports: No. 7, Dec. 13, 1963; No. 8, Jan. 13, 1964; No. 9, Feb. 13; No. 10, Mar. 11; No. 12, May 18; No. 14, July 13, 1964.

- 26 Gemini launch vehicle 1 arrived at Atlantic Missile Range and was transferred to complex 19. Stage I was erected in the complete vehicle erector October 28, stage II in the second stage erector October 29. The two stages were cabled together in the side-by-side configuration required for the Sequence Compatibility Firing scheduled for mid-December. A limited Electronic-Electrical Interference Test was completed November 7, and power was applied to the vehicle November 13.

Mission Report for GT-1, pp. 12-8, 12-23.

- 30 A meeting was held to discuss ejection seat system problems. Of major concern was the ejection seat ballute that was planned to stabilize the astronaut after he ejected and separated from the seat. Wind tunnel test data had suggested two problem areas: the ballute was failing at supersonic speeds and was not opening at subsonic speeds. Increasing the diameter and lengthening the riser lines improved performance considerably. A major system change recommended at the meeting was the incorporation of provisions for automatic separation of the seat backboard and egress kit before touchdown; Gemini Project Office directed McDonnell to study the feasibility of this recommendation.

Weekly Activity Report, Oct. 27-Nov. 2, 1963, p. 1; Abstract of Meeting on Ejection Seat System, Nov. 5, 1963.

1963
November
1

Titan II development flight N-25 was launched from the Atlantic Missile Range. It carried the oxidizer surge chamber and fuel accumulator kit intended to reduce the amplitude of longitudinal vibration which had characterized earlier flights. NASA regarded 0.25 g as the maximum level tolerable in manned space flight; this flight achieved a level of 0.22 g, the first to fall within acceptable limits. Although the kit had been tested on only one flight, Gemini Project Office had sufficient confidence in it to decide, on November 6, to procure several more such kits for subsequent installation in Gemini launch vehicles. Two later Titan II development flights (N-29 on December 12, 1963, and N-31 on January 15, 1964) and the flight of Gemini-Titan 1 confirmed the validity of this decision. The required kits for the remaining Gemini launch vehicles were then procured.

Memos, Pendley to Asst. Dir. for Flt. Ops., Nov. 7 and Dec. 19, 1963; Weekly Activity Reports: Oct. 27–Nov. 2, p. 2; Dec. 8–14, 1963, p. 2; Harris, *Gemini Launch Vehicle Chronology*, pp. 29–30.

McDonnell reviewed work on the beryllium shingles to protect the reentry control system and rendezvous and recovery structures of the spacecraft from reentry heat. A strike earlier in the year, as well as manufacturing difficulties, had delayed shingle tests. Problems in manufacturing the cross-roll beryllium shingles for Gemini included flaking, lamination, and cracking flaws in the finished shingles. At a meeting to discuss these problems, held at Pioneer Astro Industries, Chicago, Illinois, November 14, 1963, the decision was made to substitute chemical etching for machine tooling wherever possible and to use lighter cuts where machine tooling was unavoidable.

Quarterly Status Report No. 7, p. 9.

Major General Leighton I. Davis, Department of Defense (DOD) Representative for Project Gemini Support Operations, issued DOD's plan for carrying out Gemini operations. The DOD representative, acting as the single point of contact between DOD and NASA, was responsible for meeting NASA's needs for DOD support in the areas of launch, tracking network, planned and contingency recovery, communications, public affairs, and medical assistance.

DOD, Overall Plan, Department of Defense Support for Project Gemini Operations, Nov. 7, 1963; DOD Manager for Manned Space Flight Support Operations, *Summary Report: DOD Support of Project Gemini, Jan. 1963–Nov. 1966*, Mar. 6, 1967, p. 4.

Delays in the fuel cell development program prompted Gemini Project Office to direct McDonnell to modify the electrical system for spacecraft No. 3 so that either fuel cells or a silver-zinc battery power system could be installed after the spacecraft had been delivered to the Cape. A contract change incorporating this directive was issued January 20, 1964.

Message, Mathews to Burke, Nov. 12, 1963; Weekly Activity Report, Nov. 17–23, 1963, p. 1; Procurement and Contracts Division change notice, Contract NAS 9-170, Contract Change Proposal No. 16, Jan. 20, 1964.

The Gemini Management Panel, after reviewing the status of spacecraft and launch vehicle, decided that Gemini launch schedules needed reexamination, especially the amount of testing at Cape Canaveral necessary to establish

1963
November

confidence in mission success. The panel directed Gemini Project Manager Charles W. Mathews and Colonel Richard C. Dineen, Chief, Gemini Launch Vehicle, Air Force Space Systems Division, to form an ad hoc group to make an intensive 30-day study of work plans and schedules, with the goal of achieving manned flight in 1964. The next day (November 24), NASA, Air Force, and industry program managers met at the Cape to lay out study areas and then met at 10-day intervals to develop ground rules, review progress, and coordinate their efforts. Mathews reported the results of the study at the next panel meeting, December 13, and described the ground rules that might bring Gemini-Titan (GT) 3, the first manned flight, to a 1964 launch. The primary factor affecting the spacecraft would be reducing Cape duplication of tests already accomplished at McDonnell and integrating the entire test effort. Although integration of launch vehicle testing at the Cape and Martin was already fairly good, there was still room for improvement. The master schedule that emerged from this study showed the following launches: GT-1, March 17, 1964; GT-2, August 11; and GT-3, November 6. GT-1A was strictly a backup, to be flown only if GT-1 failed.

Minutes of Project Gemini Management Panel Meetings: held at Patrick AFB, Fla., Nov. 13, pp. 3-4; at MSC, Dec. 13, 1963, p. 2; Weekly Activity Report, Dec. 1-7, 1963, p. 2.

- 14 Manned Spacecraft Center (MSC) began a drop-test program over Galveston Bay using a helicopter-towed paraglider half-scale tow test vehicle to investigate trim conditions and stability characteristics in different deployment configurations. The first drop successfully tested the U-shaped deployment configuration. The second test (November 19) was abortive, but damage was slight. The third test (November 26) was also abortive, and the wing was damaged beyond repair on impact. MSC procured another wing from North American and conducted a fourth test, partially successful, on December 19. No further tests were conducted.

Weekly Activity Reports: Nov. 17-23, p. 2; Nov. 24-30, 1963, p. 2; Consolidated Activity Report, Nov. 17-Dec. 21, 1963, p. 19; Paraglider Landing System Program, Monthly Progress Reports: No. 7, Dec. 13, 1963; No. 8, Jan. 13, 1964.

- 15 The first production version of the inertial guidance system developed for Gemini was delivered to McDonnell. Special tests on the configuration test unit, using spacecraft No. 2 guidance and control equipment, were expected to be completed in January 1964.

Consolidated Activity Report, Nov. 17-Dec. 21, 1963, p. 18; NASA *Tenth Semi-annual Report to Congress, July 1-December 31, 1964*, p. 28.

- 16 Flight Crew Support Division reported an agreement with Flight Operations Division on a flight profile and rendezvous evaluation experiment for the Gemini-Titan 4 mission. Objective of the experiment was to simulate normal Agena/Gemini rendezvous and to repeat part of the maneuver using loss of signal/manual technique. Basically, the mission would use circular phasing and catch-up orbit as proposed by the Flight Crew Support Division. Exact fuel requirements and ground tracking requirements were under study by Flight Operations Division.

Consolidated Activity Report, Oct. 20-Nov. 16, 1963, p. 80.

1963
November
17

Douglas Aircraft Corporation, Tulsa, Oklahoma, began a series of tests to demonstrate the structural integrity of the Gemini target docking adapter (TDA) during shroud separation. The shroud, which protected the TDA during the launch and ascent of the Agena target vehicle, was tested under simulated altitude conditions to show proper operation of pyrotechnic devices and adequate clearance between shroud and TDA during separation. Successfully concluded on November 21, the tests demonstrated the compatibility of the TDA with the shroud system during operational performance, with no indication of damage or failure of the TDA structure.

Weekly Activity Report, Nov. 24-30, 1963, p. 1; Consolidated Activity Report, Nov. 17-Dec. 21, 1963, pp. 21-22; Quarterly Status Report No. 7, p. 69; Lockheed *Agena Monthly Report, November 1963*, p. 3-1.

A series of 24 test drops to develop the ballute stabilization system for the Gemini escape system began with a live jump over El Centro. Five more live jumps and four dummy drops, the last two on January 9, 1964, all used a ballute three feet in diameter. Excessive rates of rotation dictated increasing ballute diameter and substituting two-point for single-point suspension. Between January 14 and February 5, 14 more tests (12 human and two dummy) were conducted at altitudes from 12,500 to 35,000 feet using ballutes 42 and 48 inches in diameter. These tests established a 48-inch diameter as the optimum configuration for the Gemini ballute, and Gemini Project Office directed McDonnell to use this size in the coming qualification drop test program. Qualification of the ballute was also to include a structural test program to be conducted in the wind tunnel at Arnold Engineering Development Center.

22

Weekly Activity Reports: Nov. 17-23, p. 1; Dec. 1-7, 1963, p. 1; Jan. 5-11, 1964, p. 7; Consolidated Activity Reports: Nov. 17-Dec. 21, 1963, p. 19; Dec. 22, 1963-Jan. 18, 1964, p. 18; Jan. 19-Feb. 15, 1964, pp. 16-17, 19; Quarterly Status Reports: No. 7, p. 44; No. 8, p. 30.

Manned Spacecraft Center received proposals for the Gemini extravehicular life support package and expected to complete evaluation by the end of December. Requests for proposals had gone out in October. The system would include a high-pressure gaseous oxygen supply bottle plus suitable regulators and valves for control of oxygen flow, which would be in an open loop. It would provide necessary life support for initial extravehicular operations, using a hardline tether, of 10 to 15 minutes. A contract was awarded to the Garrett Corporation in January 1964.

25

Quarterly Status Reports: No. 7, p. 46; No. 8, p. 33.

Gemini Project Office (GPO) reported the results of a survey of testing being done at Rocketdyne on the orbit attitude and maneuver system (OAMS). The research and development phase of testing OAMS components appeared likely to extend well into 1964, with the development of an adequate thrust chamber assembly (TCA) continuing as the major problem. Hardware availability remained uncertain, no definite method of resolving the TCA life problem had yet been selected, and McDonnell's current revision of mission duty cycles compounded the problem. Lack of hardware was also delaying system testing, which would be completed no sooner than the second quarter of 1964. Persistent delays in the research and development test program were in turn responsible for serious delays in the qualification test program. To meet the manned

30



Figure 65.—Jump test of the 36-inch ballute with dual suspension at the Naval Parachute Facility, El Centro, California. The second figure is a free-falling photographer with a camera mounted in his helmet. A second observer jumped later and took this picture. (NASA Photo 64-Gemini-120, released Dec. 18, 1963.)

Gemini launch scheduled for 1964, GPO was considering the possibility of beginning qualification tests before development testing had been completed.

1963
November

Quarterly Status Report No. 7, p. 14.

Lockheed included a milestone schedule for the Gemini Agena target vehicle (GATV) in its monthly progress report for the first time since January 1963. The new schedule reflected the revised Gemini flight program of April 29 and the corresponding revision of the Agena program which followed. It displayed key events in the progress of the first GATV taking place between five and six months later than the January schedule. Engineering development was now scheduled to be completed by May 15, 1964, rather than by December 11, 1963. Completion of modification and final assembly was now planned for June 12 rather than January 10, 1964; preliminary vehicle systems testing was rescheduled from April 10 to September 11, 1964. Special tests, including a Radio Frequency Interference Test in the later schedule in addition to the hot-firing scheduled earlier, were to end November 20 instead of May 22, 1964. Final Vehicle Systems Tests were to be completed December 18 instead of June 19, 1964, with shipment to follow on January 6, 1965, rather than June 30, 1964. Launch was now expected on April 15, 1965, seven and one-half months later than the September 1, 1964, date that had been planned in January 1963.

During
the
month

Lockheed Agena Monthly Reports: January, p. 23; November 1963, p. 5-9.

The Gemini Program Planning Board issued a memorandum of understanding on the correction of Titan II deficiencies for the Gemini program. This agreement formalized NASA specifications and Air Force plans to clean up problems related to longitudinal oscillations (POGO), combustion instability, and engine improvement. The program to alleviate the POGO effect included ground proof tests of all subsystems modified to control oscillations. Flight tests of the solutions would be flown on Titan II missiles before application to the Gemini launch vehicle. For the combustion stability program, dynamic stability would be demonstrated through the use of artificially produced disturbances, with the engines being flight tested on unmanned vehicles as final proof of man-rating. Engine improvement was a program to correct all design deficiencies that had cropped up during the Titan II development flights.

December
3

Minutes of the Tenth Meeting, Gemini Program Planning Board, Dec. 3, 1963; NASA, Office of Manned Space Flight, "Gemini Launch Vehicle Supplemental Specifications," Nov. 15, 1963; "Memorandum of Understanding on Certain Design Requirements for the Gemini Launch Vehicle," signed by Seamans and McMillan, Dec. 3, 1963.

McDonnell delivered Gemini boilerplate No. 201, an egress trainer, to Houston. Preparations began for egress tests in a water tank at Ellington Air Force Base, Texas, in January 1964.

9

Consolidated Activity Report, Nov. 17-Dec. 21, 1963, p. 36.

Aerojet-General delivered the stage II engine for Gemini launch vehicle (GLV) 2 to Martin-Baltimore. The engine was installed December 31. An interim stage I engine was received December 29 and installed January 9, 1964. This engine was to be used only for tests at the Martin plant, after which it was to be replaced by a flight engine before GLV-2 was shipped to the Cape. Horizontal

10

PROJECT GEMINI: A CHRONOLOGY

1963
December

testing of GLV-2 was completed January 17. Before GLV-2 was erected in the vertical test facility, a longitudinal oscillation (POGO) kit was installed in stage I. The kit comprised an oxidizer standpipe and a fuel surge chamber designed to suppress pressure pulses in the propellant feed lines and thus reduce POGO to a level consistent with manned flight.

Mission Report for GT-2, pp. 12-11, 12-12; Aerospace *Final Report*, p. II.G-3; *Gemini-Titan II Air Force Launch Vehicle*, pp. D-3, D-4.

13

Martin-Baltimore received the propellant tanks for Gemini launch vehicle (GLV) 3 from Martin-Denver, which had begun fabricating them in June. Splicing the oxidizer and fuel tanks for each stage was completed April 17, 1964. Flight engines arrived from Aerojet-General on May 10, and installation was completed June 6. Final horizontal tests of the assembled launch vehicle began June 1 and were concluded on June 17 with an Air Force inspection of GLV-3 before the vehicle was erected in the vertical test facility.

Gemini Program Mission Report for GT-3, Gemini 3, April 1965, p. 12-25; Aerospace *Final Report*, p. II.G-3; *Gemini-Titan II Air Force Launch Vehicle*, p. D-6.

17-18

The G2C training and qualification pressure suit underwent further evaluation in conjunction with a mock-up review of the spacecraft crew station at McDonnell. In general, the suit was found to be acceptable to the crew and compatible with the spacecraft. The helmet design had been corrected satisfactorily and no new design problems were encountered. Eleven G2C suits, including five astronaut suits, would be delivered by the end of February 1964. The remaining 23 suits were scheduled for a March 1964 delivery date, when qualification and reliability testing would begin. The qualification program would be managed by the Crew Systems Division of Manned Spacecraft Center.

Consolidated Activity Report, Dec. 22, 1963-Jan. 18, 1964, p. 33; Quarterly Status Report No. 8, p. 32.

20

McDonnell shipped its portion of Gemini mission simulator No. 1 to Cape Kennedy. The computers for the training device were expected by mid-January 1964.

Consolidated Activity Report, Nov. 17-Dec. 21, 1963, p. 19.

21

Gemini Project Office (GPO) reported that a silver-zinc battery power system would be flown in spacecraft No. 3 instead of a fuel cell system, which could not be qualified in time for the mission. Late in January, 1964, McDonnell reviewed for GPO the status of the fuel cell program and discussed the design of an improved fuel cell. Early in February, GPO directed McDonnell to incorporate the improved fuel cell into spacecraft No. 5 and to delete fuel cells from spacecraft Nos. 3 and 4, substituting the battery power system.

Weekly Activity Report, Feb. 2-8, 1964, p. 11; Consolidated Activity Report, Nov. 17-Dec. 21, 1963, p. 18.

21

Gemini Project Office reported that McDonnell, as a result of a flammability test that it had conducted, would incorporate teflon-insulated wiring throughout the spacecraft. This modification would be initiated as early as possible.

Consolidated Activity Report, Nov. 17-Dec. 21, 1963, p. 18.

Persistent problems in the development of engines for the Gemini orbit attitude and maneuver system prompted a review by the management of Manned Spacecraft Center. After discussion three decisions were reached. The possibility of further reducing the oxidizer to fuel ratio (currently 1.3:1) while still maintaining stable combustion and good starting characteristics was to be investigated. Lowering this ratio would reduce operating temperatures and enhance engine life. Another investigation was to be conducted to determine the feasibility of realigning the lateral-firing thrusters more closely with the spacecraft center of gravity. Such a realignment would reduce the demand placed on the 25-pound thrusters (which had yet to demonstrate a complete mission duty cycle operation without failure) in maintaining spacecraft attitude during lateral maneuvers. The third decision was to build an engine billet with ablation material laminates oriented approximately parallel to the motor housing. A recently developed parallel laminate material in its initial tests promised to resolve the problem of obtaining the thrusters' full operational duty cycle.

1963
December
23

Consolidated Activity Report, Dec. 22, 1963-Jan. 18, 1964, pp. 15-16.

The two stages of Gemini launch vehicle 1, standing side by side on complex 19, completed the Combined Systems Test (CST) in preparation for Sequence Compatibility Firing (SCF). CST had been scheduled for December 13 but was delayed by late completion of the complex support systems for operational compatibility with the launch vehicle. The Wet Mock Simulated Flight for SCF was successfully completed January 7, 1964. The SCF scheduled for January 10 was discontinued at T-20 and rescheduled for January 14, when cold weather forced cancellation of the test. The SCF, a static firing of the stage I and stage II engines, was successfully conducted on January 21. Stage II erection in tandem followed on January 31.

31

Mission Report for GT-1, pp. 12-8, 12-9, 12-23; Aerospace *Final Report*, p. II.F-3; *Gemini-Titan Air Force Launch Vehicle*, p. D-3; Harris, *Gemini Launch Vehicle Chronology*, pp. 31, 32.

NASA Headquarters directed Gemini Project Office to take the radar and rendezvous evaluation pod out of Gemini-Titan (GT) missions 3 and 4. GT-4 would be a battery-powered long-duration flight. The pod would go on GT-5, and thus the first planned Agena flight would probably slip in the schedule.

1964
January
1

Minutes, GPO Staff Meeting, Jan. 2, 1964.

Representatives of Crew Systems Division (CSD) and David Clark Company met to review the design of the G2C training and qualification pressure suit. Several components needed approval before being incorporated into the G3C flight suit configuration; CSD completed a statement of work for procuring the flight suits January 17; G3C suit procurement was expected to begin in March. Qualification and reliability tests of the G2C suit were also expected to begin in March.

9-10

Consolidated Activity Report, Dec. 22, 1963-Jan. 18, 1964, p. 46; Quarterly Status Report No. 8, p. 32.

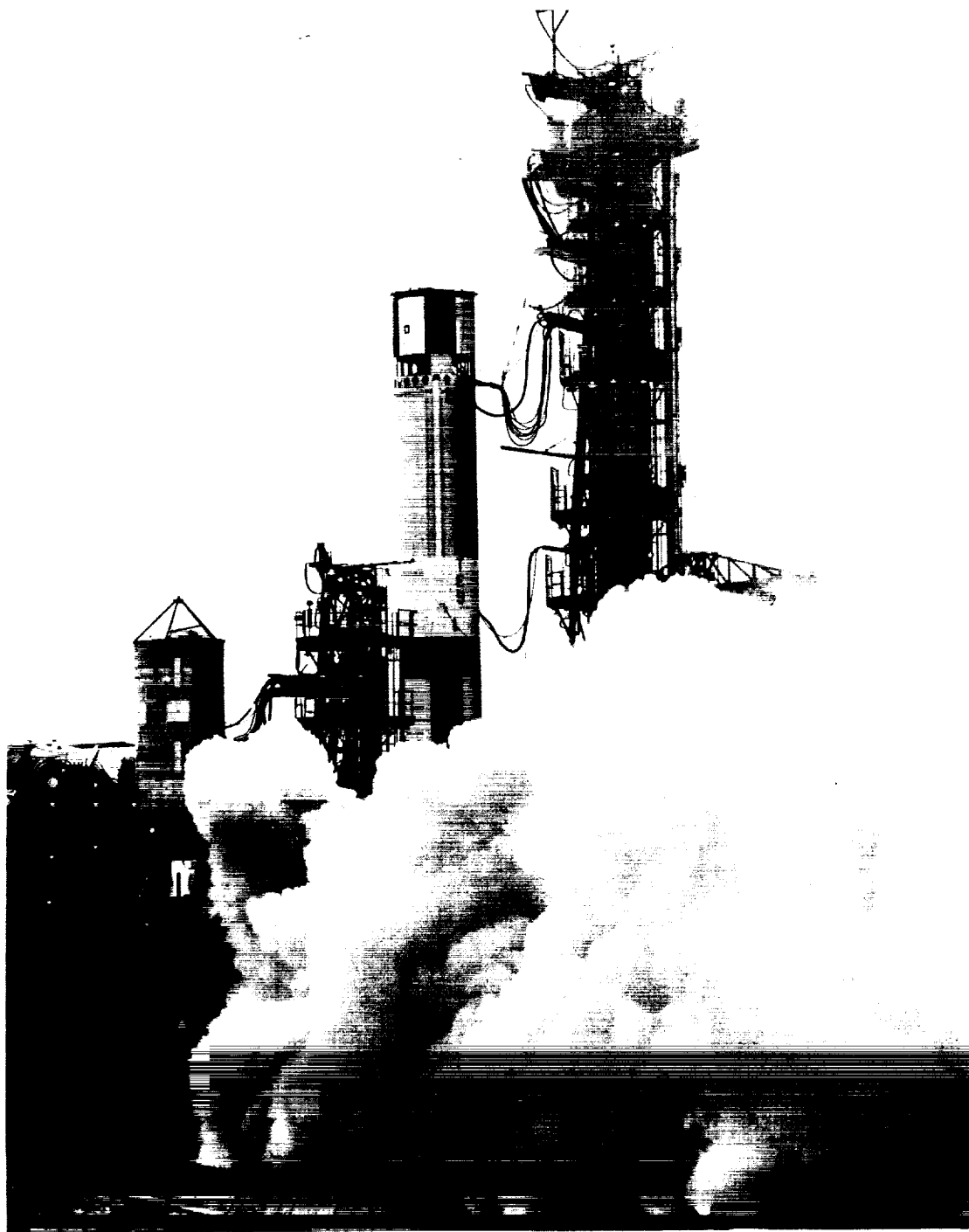

Figure 66.—Sequence Compatibility Firing of the two stages of Gemini launch vehicle 1 at pad 19, Jan. 21, 1964. (KSC Photo 64P-7, Jan. 21, 1964.)

1964
January
13

Gemini spacecraft No. 2 began Spacecraft Systems Tests (SST) at McDonnell. Phase I of SST comprised module tests. Since spacecraft No. 1 had passed through SST, checkout had been radically altered. All test activity, including manufacturing after testing had begun on a module, was performed under the direction of a Launch Preparations Group (LPG) headed by the NASA-MSC Florida Operations Assistant Manager for Gemini. The group, which included both McDonnell and NASA operators and quality control personnel from Cape Kennedy, was temporarily located in St. Louis to review and approve test procedures and to perform the various tests on spacecraft Nos. 2 and 3. The St. Louis crew originally assigned to perform this function worked with the LPG through SST on these two spacecraft, then took over SST operations when spacecraft No. 4 entered SST. Primary purpose of the change was to improve scheduling by eliminating redundant testing. Once module testing was completed, modules would be permanently mated and only mated checks would be performed on the spacecraft through the remainder of SST and throughout its checkout at the Cape. Numerous problems encountered in the modular SST of spacecraft No. 2 required troubleshooting, equipment and structural changes, and retesting, delaying the beginning of Phase II mated SST until July.

Mission Report for GT-2, pp. 12-1 to 12-3, 12-45; Quarterly Status Reports: No. 8, pp. 1, 79-80; No. 9, p. 1.

Phase I of the program to develop a drogue stabilization parachute for the Gemini parachute recovery system began with a successful test drop of boilerplate spacecraft No. 5 at El Centro. Phase I was aimed at determining the effects of deploying the pilot chute by a lanyard attached to the drogue chute. The second drop test, on January 28, was also successful, but in the third test, on February 6, the cables connecting the drogue-and-pilot-chute combination to the rendezvous and recovery (R and R) section of the boilerplate failed during pilot-chute deployment. Although the main chute deployed adequately to achieve a normal boilerplate landing, the R and R section was badly damaged when it hit the ground. Testing was temporarily suspended while McDonnell analyzed the cause of failure. Testing resumed on April 10 with the fourth drop test, and Phase I was successfully concluded on April 21 with the fifth and final drop. Boilerplate No. 5 then returned to McDonnell, where it was converted into static article No. 4A by September 18 for use in Phase III tests.

15

Weekly Activity Report, Apr. 5-11, 1964, p. 4; Consolidated Activity Reports: Dec. 22, 1963-Jan. 18, 1964, p. 18; Jan. 19-Feb. 15, p. 15; Mar. 22-Apr. 18, p. 21; Apr. 19-May 16, 1964, p. 15; Quarterly Status Reports: No. 8, p. 25; No. 9, p. 12; McDonnell *Final Report*, p. 28.

Martin-Baltimore conducted a static test-to-failure of the spacecraft/launch vehicle interface structure. Test results demonstrated a very satisfactory minimum structural margin of 23 percent above ultimate conditions expected to be met in the transonic buffet conditions of launch. Plans were made to hold a structures meeting in Houston on March 17-19, 1964, for final review of all load conditions, stress distribution, and margins, in readiness for the Gemini-Titan 1 mission.

20

Weekly Activity Report, Jan. 19-25, 1964, p. 8; Quarterly Status Report No. 8, p. 5.

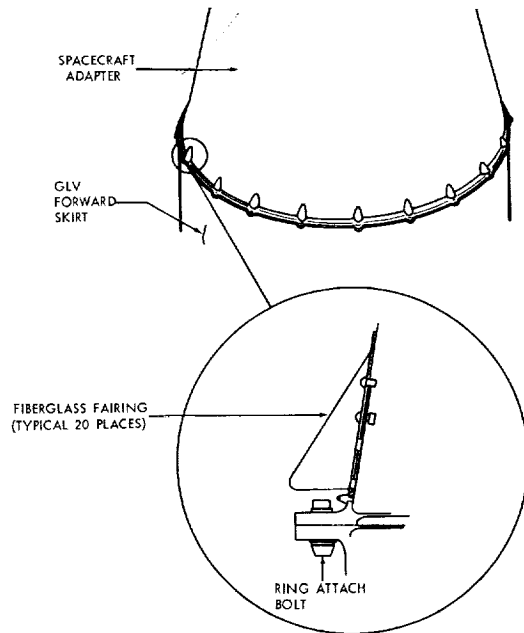

Figure 67.—The interface between Gemini launch vehicle and spacecraft. (NASA Photo S-64-3065, undated.)

1964
January
22

North American began deployment flights of the full-scale test vehicle for the Paraglider Landing System Program. The contract called for 20 tests to demonstrate deployment of the full-scale wing from the rendezvous and recovery can, followed by glide and radio-controlled maneuvering; each test was to be terminated by release of the wing and recovery by the emergency parachute system (which had been qualified on December 3, 1963). Twenty-five deployment flight tests were actually conducted. The first five flights (January 22, February 18, March 6, April 10, and April 22) achieved some success, but flight No. 6 (April 30) was the first to complete the entire sequence successfully. Flight No. 7 (May 28) was also successful. The next four flights (June 12, June 29, July 15, and July 23) again ran into trouble. A successful flight No. 12 (July 29) was followed by a series of problem flights (August 1, August 7, August 13, August 17, August 25, September 1, September 11, September 24, October 12, and October 16); the deployment sequence in these flights was generally satisfactory, but achieving a stable glide remained elusive. The last three flights (October 23, November 6, and December 1), however, successfully demonstrated the complete test sequence with no problems.

Weekly Activity Reports: Jan. 19-25, p. 7; Feb. 16-22, p. 4; Mar. 1-7, p. 1; Apr. 5-11, p. 5; Apr. 19-25, p. 2; Apr. 26-May 2, pp. 2-3; May 23-30, p. 1; June 7-13, p. 1; June 28-July 4, p. 1; July 19-25, p. 1; July 26-Aug. 1, pp. 1-2; Aug. 2-8, pp. 1-2; Aug. 16-22, p. 1; Aug. 23-29, p. 2; Aug. 30-Sept. 5, pp. 1-2; Sept. 6-12, 1964, p. 2; NAA, A Final Fee Settlement Proposal for Contract NAS 9-1484, p. V-113; Paraglider Landing System Program, Monthly Progress Reports: No. 9, Feb. 13; No. 10, Mar. 11; No. 11, Apr. 13; No. 12, May 18; No. 13, June 10; No. 14, July 13; No. 15, Aug. 7; No. 16, Sept. 16; No. 17, Oct. 19; No. 18, Nov. 11; No. 19, Dec. 11, 1964; No. 20, Jan. 15, 1965.

25

Rocketdyne tested an orbit attitude and maneuver system (OAMS) 100-pound thrust chamber assembly (TCA) to the 757-second mission duty cycle without failure. The TCA incorporated a modified injector which sprayed about 25

percent of the fuel down the wall of the chamber before burning, a technique known as boundary-layer cooling. With an oxidizer to fuel ratio of 1.2:1, the ablative material in the chamber was charred to a depth of only 0.5 inch. A second TCA, tested under the same conditions, charred to 0.55 inch. The flight-weight engine contained ablative material 1.03 inches thick, indicating that this engine configuration provided an ample margin for meeting mission requirements. These test results encouraged Gemini Project Office (GPO) to believe that boundary-layer cooling answered the problem of obtaining life requirements for the OAMS 100-pound TCAs. The same technique was also tried with the 25-pound TCA, but boundary-layer cooling was much less successful in the smaller engine; a modified rounded-edge, splash-plate injector yielded better results. This configuration was tested to the 570-second mission duty cycle using a mixture ratio of 0.7:1; at the end of the test, 0.18 inch uncharred material was left. Earlier TCAs using the same mixture ratio had failed after a maximum of 380 seconds. GPO now expected both 25- and 100-pound TCAs to be ready for installation in spacecraft 5 and up.

Weekly Activity Reports: Jan. 26–Feb. 1, p. 12; Feb. 23–29, 1964, pp. 6–7; Quarterly Status Report No. 8, pp. 19–20.

1964
January

Gemini Project Office reported that Ames Research Center had conducted a visual reentry control simulator program to evaluate the feasibility of controlling the spacecraft attitude during reentry by using the horizon as the only visual reference. Simulation confirmed previous analytical studies and showed that the reentry attitude control, using the horizon view alone, was well within astronaut capabilities.

Weekly Activity Report, Jan. 19–25, 1964, p. 8; Quarterly Status Report No. 8, p. 35.

25

The program plan for Gemini extravehicular operations was published. Objectives of the operations were to evaluate man's capabilities to perform useful tasks in a space environment, to employ extravehicular operations to augment the basic capability of the spacecraft, and to provide the capability to evaluate advanced extravehicular equipment in support of manned space flight and other national space programs. Flight Crew Operations Directorate had initiated flight activities planning based on a schedule calling for: on Gemini-Titan (GT) 4, depressurizing the cabin, opening the hatch, and standing up; on GT-5, performing complete egress and ingress maneuvers; on GT-6, egressing and proceeding to the interior of the equipment adapter and retrieving data packages; on GT-7 and GT-8, evaluating maneuvering capabilities along the spacecraft exterior by using tether and handholds; on GT-9, evaluating astronaut maneuvering unit; and on GT-10 through GT-12, evaluating other advanced extravehicular equipment and procedures. Crew Systems Division, responsible for ground test of extravehicular equipment, had initiated egress and ingress exercises in a simulated zero-gravity environment.

Consolidated Activity Report, Dec. 22, 1963–Jan. 18, 1964, p. 47; Quarterly Status Report No. 8, pp. 32–33; interview, William C. Schneider, Washington, Jan. 23, 1967.

During
the
month

McDonnell began spacecraft pyrotechnic hatch firing tests, using boilerplate No. 3A, with a single-hatch firing test. The hatch opened and locked, but open-

February
1

1964
February

ing time was 350 milliseconds, 50 milliseconds over the allowable time. This test was followed, on February 10, by a dual-hatch firing test with satisfactory results. The boilerplate spacecraft was prepared for shipment to Weber Aircraft to be used in the qualification program of the ejection seat system.

Weekly Activity Report, Feb. 2-8, 1964, p. 11; Consolidated Activity Report, Jan. 19-Feb. 15, 1964, p. 19; Quarterly Status Report No. 8, p. 6.

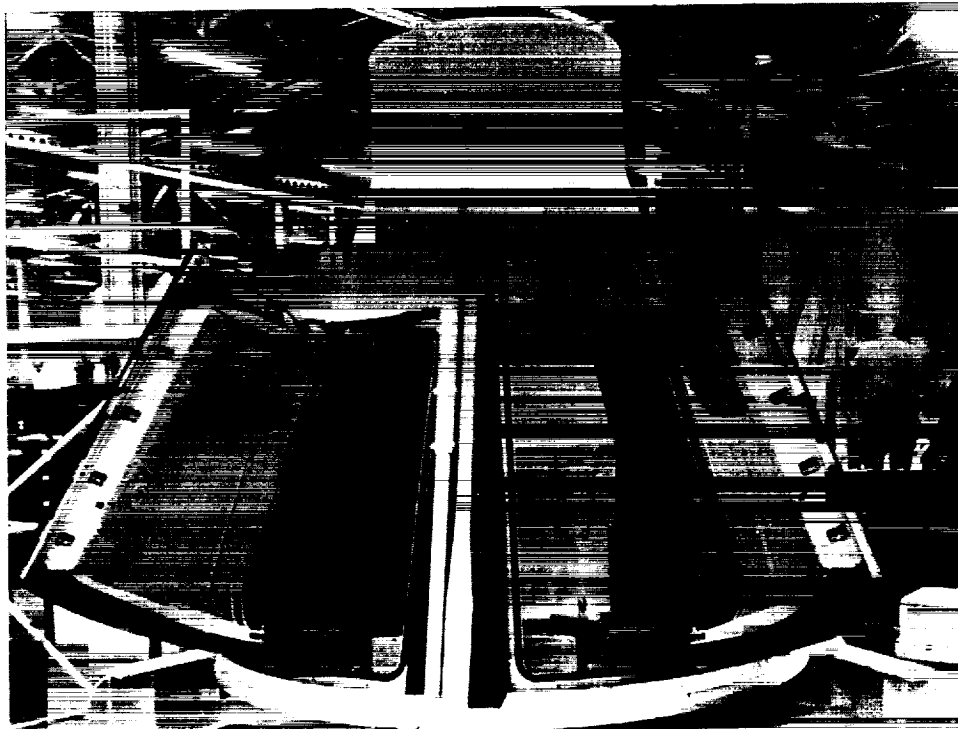

Figure 68.—Gemini boilerplate 3A in the production area at the McDonnell plant before being shipped to Weber Aircraft. (NASA Photo 1053, Feb. 18, 1964.)

- 2 Manufacture of the heatshield for spacecraft No. 3 was completed. This shield was the first production article with the full thickness of 1.0 inch; shields for spacecraft Nos. 1 and 2 were about half as thick.

Weekly Activity Report, Feb. 2-8, 1964, p. 11.

- 3 A cost-plus-incentive-fee contract for \$133,358 was awarded to the Garrett Corporation's AiResearch Manufacturing Division for the extravehicular pressurization and ventilation system. Initial phase of the contract was a study to define detailed systems configuration.

Consolidated Activity Report, Jan. 19-Feb. 15, 1964, p. 39; Quarterly Status Report No. 8, p. 33.

- 5 Gemini launch vehicle 2 stage I and interstage were erected in the vertical test facility at Martin-Baltimore. Stage II was erected February 7. Subsystems Functional Verification Tests began February 21.

Mission Report for GT-2, p. 12-12; *Gemini-Titan II Air Force Launch Vehicle*, p. D-4.

1964
February

Bell Aerosystems began Preliminary Flight Rating Tests (PFRT) of the Agena primary propulsion system (PPS). Tests were expected to be completed April 24 but were not actually concluded until late June. Testing proceeded with only minor problems through the first week of April. But in the following week PPS testing encountered what proved to be a six-week delay when the test unit's fuel and oxidizer start tanks failed. The two start tanks, stainless steel canisters with an internal bellows arrangement, supplied the propellants required to initiate the main engine start sequence. Visible longitudinal cracks in the outer shell allowed the gas which forced the propellants out of the tank to escape. Investigation revealed that the cracks had resulted from intergranular corrosion of the stainless steel tanks. The defective tanks were replaced by start tanks with a new heat-treated shell (delivered April 24), and PFRT resumed early in May.

5

Weekly Activity Reports: Mar. 22-28, pp. 1-2; Mar. 29-Apr. 4, p. 3; Apr. 5-11, p. 3; Apr. 26-May 2, p. 1; June 21-27, 1964, p. 1; Quarterly Status Reports: No. 8, p. 63; No. 9, pp. 42-43; Abstracts of Meetings on Atlas/Agena Coordination: Apr. 16, May 18, June 19, 1964.

Bernhard A. Hohmann of Aerospace expressed concern at a Gemini Management Panel meeting over spacecraft weight growth. His position was supported by Major General Ben I. Funk of Air Force Space Systems Division, who feared that mounting weight would squeeze out the Department of Defense experiments program. Funk wanted a detailed study made of the problem, with possible solutions to be discussed at a subsequent meeting of the panel. The growth of spacecraft weight was a persistent problem. At the management panel meeting of September 29, George M. Low, NASA Deputy Associate Administrator for Manned Space Flight, pointed out that spacecraft No. 8 had increased an average of 35 pounds per month since early 1963.

7

Minutes of Project Gemini Management Panel Meetings: held at SSD, Feb. 7, 1964; at Patrick AFB, Fla., Sept. 29, 1964.

Manned Spacecraft Center (MSC) reported a decision to use MSC facilities to reduce and process data for postlaunch analysis. The center had investigated the possibility of using Lockheed facilities for this purpose, but the use of center facilities would save an estimated \$300,000.

8

Weekly Activity Report, Feb. 2-8, 1964, p. 13.

Gemini Project Office reported that the developmental test program for the Gemini spacecraft retrorockets had been essentially completed at Thiokol. Qualification tests for the retrorockets would begin in March 1964.

15

Consolidated Activity Report, Jan. 19-Feb. 15, 1964, p. 17.

Manned Spacecraft Center's Flight Operations Division reported the completion of a series of simulated Gemini rendezvous missions to assess the adequacy and sequential usage of currently planned trajectory and real-time control displays.

15

Consolidated Activity Report, Jan. 19-Feb. 15, 1964, p. 24.

1964
February
16

Bell Aerosystems delivered the first Gemini Agena Model 8247 main engine to Lockheed. This engine was installed in the propulsion test vehicle assembly (PTVA), a unit to be used for a series of tests on the Agena primary and secondary propulsion systems at Lockheed's Santa Cruz Test Base. Bell delivered the two secondary propulsion system modules for the PTVA on March 6 and 14. Installation was completed and the PTVA delivered to Santa Cruz Test Base on March 26.

Weekly Activity Reports: Mar. 22-28, p. 2; Mar. 29-Apr. 4, 1964, p. 3; Quarterly Status Reports: No. 8, p. 63; No. 9, p. 43; Lockheed *Agena Monthly Reports*: February, p. 3-5; March 1964, p. 3-4.

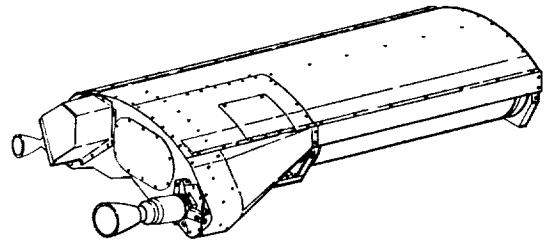
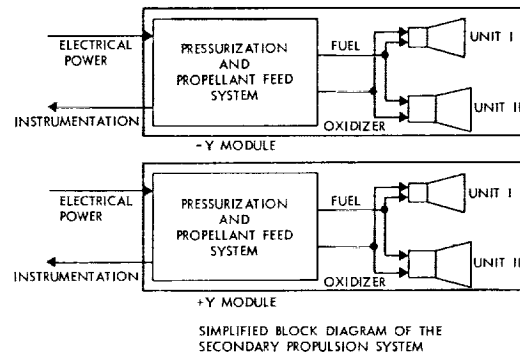

Figure 69.—The Agena secondary propulsion system. (Lockheed, "Gemini Agena Target Vehicle Familiarization Handbook," LMSO A602521, Apr. 1, 1964, pp. 4-1, 4-3.)



17

Bell Aerosystems began Preliminary Flight Rating Tests (PFRT) of the Agena secondary propulsion system (SPS). After proceeding through the acceleration and vibration test phases of PFRT without incident, the SPS began calibration firings early in April. The failure of a propellant valve in Unit I (the 16-pound thrust chamber fired prior to starting the main engine in order to orient propellant) of the SPS imposed a minor delay, but a more serious problem emerged late in April during high-temperature firings. The wall of the Unit II 200-pound thrust chamber burned through near the injector face after an accumulated PFRT firing time of 354 seconds, below the specification limit of 400 seconds although well in excess of the maximum orbital useful time of 200 seconds. The thrust chamber was replaced and testing continued, but PFRT, originally scheduled to end June 19, was first slipped to July 8, and finally completed in mid-August. To resolve the burn-through problem, Bell began a test program in September to determine the cause of failure.

Weekly Activity Reports: Mar. 22-28, pp. 1-2; Mar. 29-Apr. 4, p. 3; Apr. 5-11, p. 3; Apr. 19-25, 1964, p. 1; Quarterly Status Report No. 8, p. 63; Abstracts of Meetings on Atlas/Agena Coordination: Apr. 16, May 18, June 19, Aug. 27, 1964.

Gemini Program Office conducted the preflight readiness review of Gemini spacecraft No. 1 at Cape Kennedy. This review followed the completion of Spacecraft Systems Tests in the industrial area at the Cape on February 12. Each spacecraft system was reviewed for open items, deviations, qualification status. None of the several open items constrained the mating of the spacecraft to its launch vehicle, and none appeared to indicate a delay in launch. The spacecraft was transferred to complex 19 on March 3 and placed in the spacecraft erector support assembly in the erector white room. The premate Spacecraft Systems Test was successfully performed March 4.

1964
February
18-19

Mission Report for GT-1, pp. 12-1, 12-11, 12-22; Quarterly Status Report No. 8, p. 79.

George E. Mueller, NASA Associate Administrator for Manned Space Flight, informed the staff of the Gemini Project Office (GPO) that all 12 Gemini flights would end in water landings, although Project Gemini Quarterly Report No. 8 for the period ending February 29, 1964, still listed the paraglider for the last three Gemini missions. At the GPO staff meeting of April 29, it was decided to reduce the level of activity on the paraglider program and begin to phase it out of the Gemini program. Representatives of NASA and North American met on May 4 and agreed to continue concentrating primarily on the flight test portion of the program. But paraglider was dead as far as Gemini was concerned. On June 12, Gemini Project Manager Charles W. Mathews notified the Gemini Procurement Office that GPO had deleted the requirement for a paraglider recovery system from the Gemini program and requested that the appropriate change in the McDonnell contract be expedited. The public announcement that the paraglider had definitely been canceled from the Gemini program came on August 10, 1964.

20

Memo, Mathews to Stephen D. Armstrong, Subj: Contract NAS 9-170, Paraglider Recovery System, CCP No. 5, June 12, 1964; Quarterly Status Report No. 8, p. 58; Minutes, GPO Staff Meetings: Feb. 20, Apr. 29, May 7, 1964; NAA, A Final Fee Settlement Proposal for Contract NAS 9-1484, Sect. III; *Astronautics and Aeronautics, 1964: Chronology on Science, Technology, and Policy*, NASA SP-4005, p. 280.

Gemini launch vehicle 1 Subsystems Functional Verification Tests (SSFVT) began on complex 19. These repeated the SSFVT performed at Martin-Baltimore in the vertical test facility. Their purpose was to verify the vehicle's readiness to begin systems tests. SSFVT were completed on March 3.

21

Mission Report for GT-1, pp. 12-9, 12-23; *Aerospace Final Report*, p. II.F-2; *Gemini-Titan II Air Force Launch Vehicle*, p. 4-14.

George M. Low, NASA Deputy Associate Administrator for Manned Space Flight, informed Gemini Project Manager Charles W. Mathews of experiments approved for the first five Gemini missions. NASA Associate Administrator Robert C. Seamans, Jr., had approved the recommendations of the Manned Space Flight Experiments Board, subject to completion of Gemini Project Office (GPO) feasibility studies. The approved list of experiments did not include experiments required to secure design information for Gemini and Apollo, which GPO was authorized to add as first priority items. All experiments were

26

1964
February

classified as Category B, which meant that experiments would not be included if inclusion would delay a scheduled launch.

Memo, Low to Mathews, Subj: Experiments for Gemini missions GT-1, GT-2, GT-3, GT-4 and GT-5, Feb. 26, 1964.

28

Gemini Project Manager Charles W. Mathews informed Manned Spacecraft Center senior staff of efforts to control Gemini spacecraft weight and configuration more tightly. Mathews had assigned Lewis R. Fisher of his office to head a Systems Integration Office within Gemini Project Office to oversee these efforts by keeping very precise accounts of spacecraft weight, interface actions between the spacecraft and launch vehicle, and interface actions between the spacecraft and the Agena target vehicle.

MSC Minutes of Senior Staff Meeting, Feb. 28, 1964, p. 6; interview, Fisher, Houston, Mar. 24, 1966.

29

Gemini Project Office reported the initiation of backup engine programs should current efforts to solve development problems with the orbit attitude and maneuver system thrusters be unsuccessful or additional requirements be imposed on the spacecraft. Marshall Space Flight Center was to develop a 100-pound engine, with possible application to the Saturn S-IVB launch vehicle as well as the Gemini spacecraft. Manned Spacecraft Center was developing a 25-pound radiation-cooled engine.

Quarterly Status Report No. 8, p. 20.

29

Gemini Project Office (GPO) reported the results of a test program to determine the possible effects of cracked throats or liners on the orbit attitude and maneuver system thrusters. Because of the manufacturing process, almost all thrust chamber assemblies (TCA) had such cracks and consequently could not be delivered. The tests showed no apparent degradation of engine life caused by cracks, and Rocketdyne claimed that no TCA in any of their five space engine programs had failed because of a cracked throat. With certain restrictions, cracked throats were to be accepted. GPO expected this problem to be reduced or eliminated in the new boundary-layer cooled TCAs, the throats of which had appeared in good condition after testing.

Quarterly Status Report No. 8, p. 20.

March
5

Gemini launch vehicle (GLV) 1 and spacecraft No. 1 were mechanically mated at complex 19. Before GLV and spacecraft were electrically mated, the launch vehicle's status was reverified with a Combined Systems Test (CST) performed on March 10. A special series of Electronic-Electrical Interference (EEI) Tests began March 12 and ended March 25. Evaluation of test results confirmed that the intent of EEI testing had been accomplished, despite some persistent anomalies. A successful post-EEI systems reverification CST was performed March 27.

Mission Report for GT-1, pp. 12-9, 12-23; Aerospace *Final Report*, p. II.F-3; *Gemini-Titan II Air Force Launch Vehicle*, p. 4-14; Harris, *Gemini Launch Vehicle Chronology*, pp. 34-35.

6

Martin-Baltimore received the propellant tanks for Gemini launch vehicle 4 from Martin-Denver, which had begun fabricating them in November 1963.

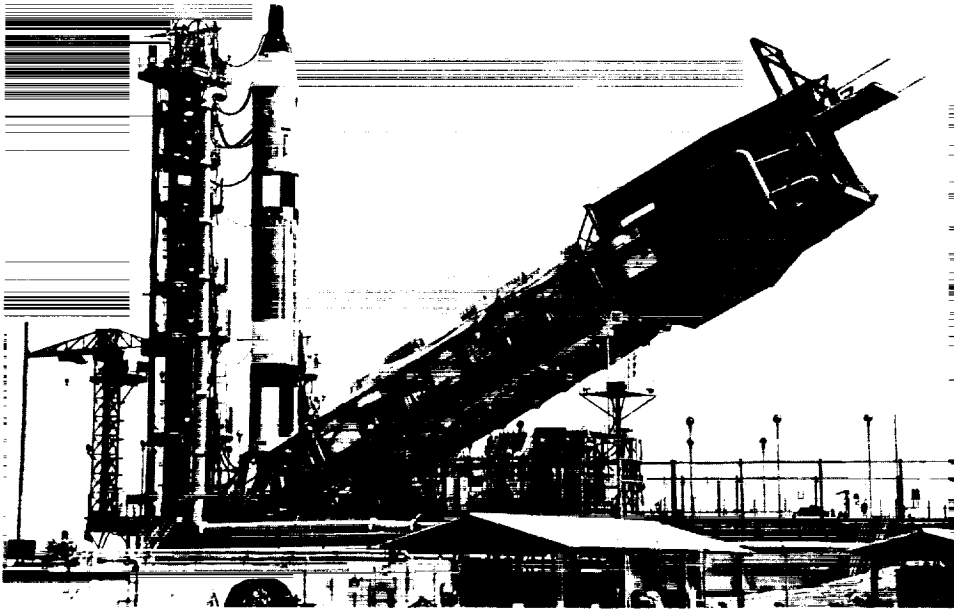

Figure 70.—Gemini-Titan 1 during Electronic-Electrical Interference Tests with the launch-vehicle erector lowered. (NASA Photo No. 64-Gemini 1-44.)

Tank splicing was completed July 21. Aerojet-General delivered the stage II flight engine June 26, the stage I engine July 28. Engine installation was completed September 4. Final horizontal tests were completed and reviewed October 26, with Martin authorized to erect the vehicle in the vertical test facility.

1964
March

Gemini Program Mission Report, Gemini IV, July 1965, p. 12-26; Aerospace Final Report, p. II.G-5; Gemini-Titan II Air Force Launch Vehicle, p. D-8.

The structures panel met to review and clear up all open items concerning the structural integrity of the interface between the spacecraft adapter section and the launch vehicle upper skirt. An unexpected snag developed when an analysis by Aerospace indicated load factors about 10 times greater than McDonnell had predicted. Further analysis by McDonnell confirmed its original estimate.

17-19

MSC Minutes of Senior Staff Meeting, Mar. 20, 1964, p. 6; Consolidated Activity Report, Feb. 16-Mar. 21, 1964, p. 21; Yardley interview.

The Air Force Systems Command weekly report (inaugurated in September 1963) summarizing actions taken to resolve Titan II development problems would no longer be issued. George E. Mueller, NASA Associate Administrator for Manned Space Flight, informed Associate Administrator Robert C. Seamans, Jr., that the launch vehicle "no longer appears to be the pacing item in the Gemini program."

19

Memo, Mueller to Seamans, Subj: Gemini Launch Vehicle Weekly TWX, Mar. 17, 1964, with Seamans' concurrence.

Manned Spacecraft Center (MSC) approved Air Force Space Systems Division's (SSD) recommendations for a test program to increase confidence in 16 critical electronic and electrical components of the Gemini Agena target

20

1964
March

vehicle. The program included complete electromagnetic interference (EMI) testing of all components peculiar to the Gemini mission, as well as elevated stress tests and extended life tests. SSD had also recommended subsystem-level, as well as component-level, EMI testing, but this part of the program MSC disapproved. SSD directed Lockheed to proceed with the program on March 23. EMI tests were scheduled to be completed by July 1, stress and life tests by September 1, 1964.

Minutes of Project Gemini Management Panel Meeting held at Martin-Baltimore, Apr. 15, 1964, Fig. B-3-1; *GATV Progress Report*, December 1964, pp. 2-7, 2-10, 2-12, 2-13.

25

At a meeting of the Gemini Project Office's Trajectories and Orbits Panel, members of Flight Operations Division described two mission plans currently under consideration for the first Agena rendezvous flight. One was based on the concept of tangential Agena and spacecraft orbits, as proposed by Howard W. Tindall, Jr., and James T. Rose when they were members of Space Task Group. The second plan, based on a proposal by Edwin E. Aldrin, Jr., then of Air Force Space Systems Division, involved orbits which were concentric rather than tangential. The most significant advantage of the second plan was that it provided the greatest utilization of onboard backup techniques; that is, it was specifically designed to make optimum use of remaining onboard systems in the event of failures in the inertial guidance system platform, computer, or radar.

Abstract of Meeting on Trajectories and Orbits, Mar. 27, 1964; Aldrin interview.

26

Boilerplate spacecraft No. 4 was subjected to its first drop from a test rig. The boilerplate achieved a horizontal velocity of 60 feet per second and a vertical velocity of about 40 feet per second at the time of impact with the water. The test was conducted to obtain data on landing accelerations for various speeds and attitudes of the spacecraft.

Weekly Activity Report, Mar. 22-28, 1964, p. 3.

26

The propulsion test vehicle assembly (PTVA) arrived at Santa Cruz Test Base. It consisted of a basic Agena structure with propellant pressurization, feed-and-load system, the primary propulsion system (PPS), and two secondary propulsion system (SPS) modules attached to the aft rack. The test program called for loading operations and hot firings of both propulsion systems to establish the adequacy of PPS and SPS propellant loading systems and associated ground equipment, to demonstrate proper overall system operation, and to provide engineering data on systems operation and the resulting environment. Start of testing was delayed by the PPS start tank problems which showed up during Preliminary Flight Rating Tests at Bell Aerosystems during April. Lockheed returned the PTVA main engine start tanks to Bell, where they were inspected and found to be defective. New tanks were ready by mid-May, but additional minor problems delayed the initiation of hot-firing until June 16.

Weekly Activity Reports: Apr. 19-25, p. 1; Apr. 26-May 2, 1964, p. 1; Lockheed *Agena Monthly Reports: March*, p. 3-4; *June 1964*, p. 3-8; *Aerospace Final Report*, p. III. F-2.

28

Gemini Project Office reported the results of the potability tests of water

from the fuel cells to be used on spacecraft No. 2. Although slightly acidic, the water was deemed suitable for drinking.

1964
March

Weekly Activity Report, Mar. 22-28, 1964, p. 3.

Director Robert R. Gilruth announced the reorganization of the Florida unit of Manned Spacecraft Center (MSC). Renamed MSC-Florida Operations, it would be headed by G. Merritt Preston, who had been in charge of MSC activities at the Cape since 1961. Responsibilities of the reorganized MSC-Florida Operations were similar to those performed and conducted during Project Mercury, with one major exception: Florida personnel would participate in spacecraft testing at McDonnell, thus eliminating the need for so much duplicate testing at the Cape by ensuring the delivery of a flight-ready spacecraft to the Cape.

30

MSC *Space News Roundup*, Apr. 15, 1964, p. 8; interviews: Preston and John J. Williams, Kennedy Space Center, Fla., May 24, 1967.

Electrical and mechanical modification of Gemini launch vehicle (GLV) 1 airborne components was completed. GLV-1 had been shipped to the Cape equipped with several items to be used only for ground tests. These were replaced with flight units, beginning January 31. The GLV-1 Wet Mock Simulated Launch, a complete countdown exercise including propellant loading, was successfully completed April 2. Testing concluded on April 5 with a Simulated Flight Test.

31

Mission Report for GT-1, pp. 12-9, 12-10, 12-23; *Aerospace Final Report*, p. II.F-3; *Gemini-Titan II Air Force Launch Vehicle*, pp. 4-18, D-3; Harris, *Gemini Launch Vehicle Chronology*, p. 36.

Astronauts visited St. Louis to conduct an operational evaluation of the translation and docking trainer. They noted minor discrepancies which McDonnell corrected. The company completed engineering evaluation tests on April 6. The trainer was then disassembled for shipment to Manned Spacecraft Center, Houston.

April
1

Consolidated Activity Report, Mar. 22-Apr. 18, 1964, p. 38; Quarterly Status Report No. 9, p. 56.

A 36-hour open-sea qualification test, using static article No. 5, began in Galveston Bay. The test ended after two hours when the test subjects became seasick. Among the technical problems encountered during this two-hour exposure were the failure of one of the suit ventilation fans and structural failure of the high-frequency whip antenna.

2

Weekly Activity Report, Mar. 29-Apr. 4, 1964, pp. 3-4.

The first mission in the Gemini program, designated *Gemini-Titan 1 (GT-1)*, was successfully launched from complex 19 at Cape Kennedy at 11:00 a.m., e.s.t. *GT-1* was an unmanned mission using the first production Gemini spacecraft and launch vehicle (GLV). Its primary purpose was to verify the structural integrity of the GLV and spacecraft, as well as to demonstrate the GLV's ability to place the spacecraft into a prescribed Earth orbit. Mission plans did not include separation of the spacecraft from stage II of the GLV, and both were inserted into orbit as a unit six minutes after launch. The planned mission

8

1964
April

included only the first three orbits and ended about 4 hours and 50 minutes after liftoff with the third orbital pass over Cape Kennedy. No recovery was planned for this mission, but Goddard continued to track the spacecraft until it reentered the atmosphere on the 64th orbital pass over the southern Atlantic Ocean (April 12) and disintegrated. The flight qualified the GLV and its systems and the structure of the spacecraft.

Mission Report for GT-1, pp. 2-1, 2-2; MSC Fact Sheet 291, *Gemini Program*, February 1965, p. 4; Aerospace *Final Report*, p. II.G-3.

- 9 The 33rd and last Titan II research and development flight was launched from Cape Kennedy. This Air Force-conducted test program contributed significantly to the development of the Gemini launch vehicle; the Gemini malfunction detection system was tested on five flights, Gemini guidance components on three, and the longitudinal oscillation fix on four. In addition to flight testing these (and other) critical components, these flights also enhanced confidence in the use of the Titan II as a launch vehicle. Thirty-two Titan II test flights were analyzed to determine whether any characteristic of the flight would have demanded a Gemini abort; 22 were adjudged successful from the standpoint of a Gemini mission, nine would have required Gemini to abort, and one resulted in a prelaunch shutdown.

Quarterly Status Report No. 9, p. 33; memo, Rosen to Boone, Subj: Gemini Launch Vehicle Man-rating, Oct. 8, 1965.

- 9 Phase II of the program to incorporate a drogue stabilization chute in the parachute recovery system began at El Centro. The purpose of Phase II was to develop the stabilization chute and determine its reefing parameters. The first



Figure 71.—Parachute test vehicle after drop test on July 16, 1964. (NASA Photo No. 64-H 2451, July 16, 1964.)

test in the series, which used a weighted, instrumented, bomb-shaped parachute test vehicle (PTV), experienced several malfunctions culminating in the loss of all parachutes and the destruction of the PTV when it hit the

1964
April

ground. Subsequent analysis failed to isolate the precise cause of the malfunctions. No useful data were obtained from the second drop, on May 5, when an emergency drag chute inadvertently deployed and prevented the PTV from achieving proper test conditions. Subsequent tests, however, were largely successful, and Phase II ended on November 19 with the 15th drop in the PTV series. This completed developmental testing of the parachute recovery system drogue configuration; qualification tests began December 17.

Weekly Activity Reports: May 17-23, p. 1; June 28-July 4, 1964, p. 1; Consolidated Activity Reports: Mar. 22-Apr. 18, p. 21; Apr. 19-May 16, p. 17; May 17-June 20, pp. 18-19; June 21-July 18, p. 17; July 19-Aug. 22, p. 17; Aug. 23-Sept. 19, p. 18; Sept. 20-Oct. 17, pp. 18-19; Oct. 18-Nov. 30, 1964, p. 17; Quarterly Status Reports: No. 9, p. 12; No. 10 for Period Ending Aug. 31, 1964, p. 21; No. 11 for Period Ending Nov. 30, 1964, pp. 17-18.

Structural qualification testing of the ballute stabilization system was completed in the wind tunnel at Arnold Engineering Development Center. Two subsonic and four supersonic runs at design conditions and two ultimate runs at 150 percent of design maximum dynamic pressure showed the four-foot ballute to be fully satisfactory as a stabilization device. Final qualification of the ballute was completed as part of a personnel parachute, high-altitude, drop test program which began in January 1965.

9

Weekly Activity Report, Apr. 5-11, 1964, p. 4; Quarterly Status Report No. 9, pp. 14-15.

Members of the Flight Crew Support Division (FCSD) visited McDonnell to review and discuss Gemini cockpit stowage problems. To aid in determining stowage requirements, they carried with them a mock-up of the 16-millimeter camera window mount, the flight medical kit, defecation gloves, and the star chart and holder. FCSD felt that stowage might become critical during the fourth Gemini mission, mainly because of the large volume of camera equipment.

9

Consolidated Activity Report, Mar. 22-Apr. 18, 1964, p. 39.

Arnold Engineering Development Center conducted a test program to determine the heat level on the base of the Gemini spacecraft during firing of the retrorockets under abort conditions from altitudes of 150,000 feet and up. Preliminary evaluation indicated that no base heating problem existed.

9

Weekly Activity Report, Apr. 5-11, 1964, p. 4.

Crew Systems Division held a design review of Gemini food, water, and waste management systems. Production prototypes of the urine transport system, water dispenser, feeder bag, first day urine collection bag, and sampling device were reviewed. The urine transport system and water dispenser designs were approved. Remaining items were approved in concept but required further work.

9-10

Consolidated Activity Report, Mar. 22-Apr. 18, 1964, p. 66.

Director Robert R. Gilruth, Manned Spacecraft Center, announced Astronauts Virgil I. Grissom and John W. Young as the prime crew for the first manned

13

1964
April

Gemini flight. Astronauts Walter M. Schirra, Jr., and Thomas P. Stafford would be the backup crew.

Astronautics and Aeronautics, 1964, p. 134.

- 13 Air Force Space Systems Division (SSD) recommended a Gemini Agena launch on a nonrendezvous mission to improve confidence in target vehicle performance before undertaking a rendezvous mission. Gemini Project Office (GPO) rejected this plan, regarding it as impractical within current schedule, launch sequence, and cost restraints. GPO accepted, however, SSD's alternate recommendation that one target vehicle be designated a development test vehicle (DTV) to permit more extensive subsystems and systems testing, malfunction studies, and modifications at the Lockheed plant. Gemini Agena target vehicle (GATV) 5001 was designated the DTV, but GPO insisted that it be maintained in flight status until the program office authorized its removal. All previously planned tests were still necessary to demonstrate satisfactory performance of GATV 5001 as a flight vehicle. GATV 5001 was the first Agena for the Gemini program.

Minutes of Project Gemini Management Panel Meeting held at Martin-Baltimore, Apr. 15, 1964, Fig. B-3-4; Quarterly Status Report No. 9, p. 41; Abstract of Meeting on Atlas/Agena Coordination, July 16, 1964.

- 14 Electrical-Electronic Interference Tests began on Gemini launch vehicle (GLV) 2 in the vertical test facility at Martin-Baltimore. Oscillograph recorders monitored 20 GLV and aerospace ground equipment (AGE) circuits, five of which displayed anomalies. Two hydraulic switchover circuits showed voltage transients exceeding failure criteria, but a special test fixed this anomaly in the AGE rather than the GLV.

Mission Report for GT-2, pp. 12-12, 12-13; *Gemini-Titan II Air Force Launch Vehicle*, p. D-4.

- 15 After reviewing the results of *Gemini-Titan (GT) 1*, the Gemini Management Panel remained optimistic that manned flight could be accomplished in 1964. According to the work schedule, GT-2 could fly on August 24 and GT-3 on November 16, with comfortable allowances for four-week slips for each mission. Some special attention was devoted to GT-2, where the spacecraft had become the pacing item, a position held by the launch vehicle on *GT-1*. Spacecraft No. 2 systems tests had started one month late but were proceeding well. In addition, the schedule looked tight for starting spacecraft No. 3 systems tests on June 1.

Minutes of Project Gemini Management Panel Meeting held at Martin-Baltimore, Apr. 15, 1964.

- 22 The formal Combined Systems Acceptance Test (CSAT) of Gemini launch vehicle (GLV) 2 was satisfactorily completed in the vertical test facility at Martin-Baltimore. Three preliminary CSATs (April 17-20) had been completed and all anomalies resolved. Three additional nonscheduled tests were conducted on GLV-2 before it was removed from the test facility. A Radio Frequency Susceptibility Test was required to demonstrate the ability of GLV-2 ordnance to withstand an electromagnetic field strength up to 100 watts per square meter with live ordnance items connected in flight con-

figuration (April 26). An Electrical-Electronic Interference Test was conducted across the interface between the GLV and a spacecraft simulator (May 1). The rate switch package, damaged in the CSAT of April 17, was replaced after formal CSAT and had to be retested.

April
1964

Mission Report for GT-2, p. 12-13; Aerospace *Final Report*, p. II.G-3; *Gemini-Titan II Air Force Launch Vehicle*, p. D-4; Harris, *Gemini Launch Vehicle Chronology*, p. 37.

The vehicle acceptance team (VAT) for Gemini launch vehicle (GLV) 2 convened at Martin-Baltimore. The VAT inspection was completed May 1 with GLV-2 found acceptable. GLV-2 was decreeted the next day (May 2) and transferred to the assembly area where the interim stage I engine was removed and the new flight engine installed (May 11-June 13). Representatives of Air Force Space Systems Division (SSD), Aerospace, and NASA conducted the official roll-out inspection of GLV-2 June 17-18, and SSD formally accepted the vehicle June 22. GLV-2 delivery to Eastern Test Range (ETR), formerly Atlantic Missile Range, was rescheduled from June 22 to July 10. The time was used to complete modifications that had been scheduled at ETR. GLV-2 was airlifted to ETR on July 11.

27

Mission Report for GT-2, pp. 12-14, 12-15; Aerospace *Final Report*, p. II.G-3; *Gemini-Titan II Air Force Launch Vehicle*, p. D-4; Harris, *Gemini Launch Vehicle Chronology*, p. 37.

AiResearch completed tests of the G2C suit to determine carbon dioxide wash-out efficiency, suit pressure drop, and outlet dew point of various metabolism rates. Crew Systems Division began qualification and reliability testing of the suit during April.

30

Consolidated Activity Report, Apr. 19-May 16, 1964, p. 57; Quarterly Status Report No. 9, pp. 16-17.

Air Force Space Systems Division (SSD) accepted the first Agena D (AD-71) for the Gemini program. The Agena D was a production-line vehicle procured from Lockheed by SSD for NASA through routine procedures. Following minor retrofit operations, the vehicle, now designated Gemini Agena target vehicle 5001, entered the manufacturing final assembly area at the Lockheed plant on May 14. There began the conversion of the Agena D into a target vehicle for Gemini rendezvous missions. Major modifications were installation of a target docking adapter (supplied by McDonnell), an auxiliary equipment rack, external status displays, a secondary propulsion system, and an L-band tracking radar.

30
May

Consolidated Activity Report, Apr. 19-May 16, 1964, p. 17; Lockheed *Agena Monthly Report, May, 1964*, p. 3-6; Aerospace *Final Report*, pp. III.F-1, III.G-3.

The spacecraft computer formal qualification unit completed Predelivery Acceptance Tests (PDA) and was delivered to McDonnell. The flight unit for spacecraft No. 2 was delivered during the first week in May. Later in the month, a complete inertial guidance system formal integration PDA was completed on spacecraft No. 2 (May 22). The spacecraft No. 3 flight unit completed PDA on June 6.

1

Quarterly Status Report No. 9, p. 19.

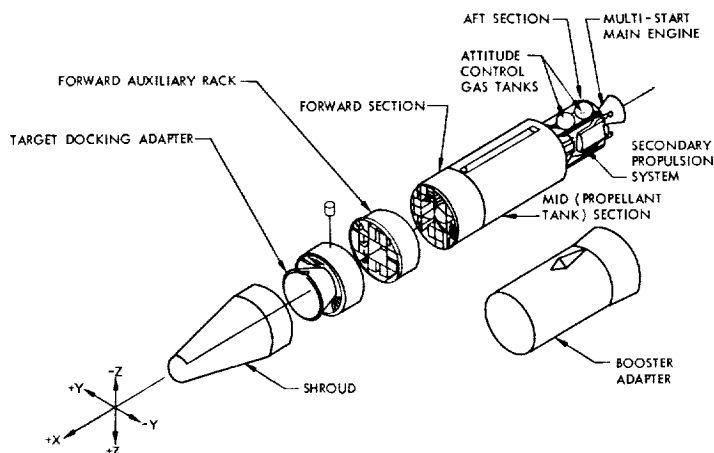

Figure 72.—Configuration of the Gemini Agena target vehicle. (Lockheed, "Gemini Agena Target Vehicle Familiarization Handbook," LMSC A602521, Apr. 1, 1964, p. 1-6.)

1964
May
5

The first of a series of three tests, using static article No. 7, to complete the qualification of the Gemini parachute recovery system for spacecraft No. 2 was conducted at El Centro. This configuration did not include the drogue stabilization chute being developed for spacecraft Nos. 3 and up. Several failures marred the first test drop, requiring McDonnell to redesign and strengthen the brackets that attached the parachute container to the rendezvous and recovery section and to redesign the sequencing circuit. Further work on the brackets was needed after the second test, on May 28, when the brackets buckled, though they did not fail. The third and final test, on June 18, successfully completed the qualification of the parachute system. Static article No. 7 was then modified for use in Phase III testing to qualify the revised parachute system incorporating the drogue chute. Phase III began December 17.

Consolidated Activity Reports: Apr. 19–May 16, p. 16; May 17–June 20, 1964, p. 19; Quarterly Status Reports: No. 9, pp. 12–13; No. 10, p. 21.

5-7

Manned Spacecraft Center's Landing and Recovery Division conducted rough water suitability tests with Gemini boilerplate spacecraft in the Gulf of Mexico. Sea conditions during the tests were 4- to 8-foot waves and 20- to 25-knot surface winds. Tests were conducted with the flotation collar which had been air-dropped. Egress from the spacecraft on the water was carried out and the survival kit recovery beacon was exercised. The tests of the dye marker produced a water pattern that was not completely satisfactory. The flotation collar endured the rough seas quite well.

Weekly Activity Report, May 3–9, 1964, p. 2.

8

Langley Research Center completed tests on a model of the Gemini launch vehicle to determine the static and dynamic loads imposed on the vehicle and the launch vehicle erector by ground winds. Simulated wind velocities of 5 to 52 miles per hour did not produce loads great enough to be of concern. Tests had begun on April 15.

- Weekly Activity Report, Apr. 26–May 2, 1964, pp. 1–2; Quarterly Status Report No. 9, p. 47. 1964
May
- Sea trials of the tracking ship, *Rose Knot*, were begun on Chesapeake Bay to study the effects of shock vibrations on Gemini equipment. A few vibration problems with the pulse-code-modulation system were reported. Gemini-Agena systems were simulated by an instrumented Lockheed Super Constellation aircraft. 11
- Quarterly Status Report No. 9, p. 51; *Astronautics and Aeronautics*, 1964, p. 197.
- Primary and backup crews for Gemini-Titan 3 inspected a spacecraft No. 3 crew station mock-up at McDonnell. They found all major aspects of the crew station acceptable. A few items remained to be corrected but would not affect the launch schedule. 11–12
- Quarterly Status Report No. 9, p. 15.
- Flight Operations Division presented the Gemini Program Office's proposed mission plan No. 3 for the first Agena rendezvous flight to the Trajectories and Orbits Panel. Plan No. 3, as yet incomplete, provided for rendezvous at first apogee on a perfectly nominal mission. 13
- Abstract of Meeting on Trajectories and Orbits, May 19, 1964.
- Manned Spacecraft Center requested that McDonnell submit a proposal to convert the Gemini spacecraft contract to a cost-plus-incentive-fee type. During the week of April 6, 1964, Gemini Program Manager Charles W. Mathews appointed a committee, headed by Deputy Manager Kenneth S. Kleinknecht, to prepare the request for proposal. The Gemini Program Office completed and reviewed the performance and scheduled criteria, upon which the request would be based, during the week of April 19. NASA Headquarters approved the request for proposal during the week of May 3. 19
- Weekly Activity Reports: Apr. 5–11, pp. 4–5; Apr. 19–25, p. 2; May 3–9, p. 3; May 17–23, 1964, p. 1; Consolidated Activity Report, Apr. 19–May 16, 1964, p. 46; Oldeg interview.
- Gemini spacecraft No. 3 began Phase I modular Spacecraft Systems Tests (SST) at McDonnell under the direction of the Launch Preparation Group. The Development Engineering Inspection of the spacecraft was held June 9–10. The new rendezvous and recovery section, incorporating the high-altitude drogue parachute, was installed and checked out during July and August. Modular SST and preparations for Phase II mated SST were completed September 12. 29
- Mission Report for GT-3, pp. 12–21, 12–22; Weekly Activity Report, June 7–13, 1964, p. 1; Quarterly Status Report No. 9, p. 47.
- Manned Spacecraft Center (MSC) reported that several devices to familiarize the flight crews with the scheduled extravehicular tests were being developed. The crews would receive training on a device called a "data simulator," which simulated the mechanical effects of zero-g environment. Gemini boilerplate No. 2 would be used in the vacuum chamber. A KC-135 aircraft flying zero-g parabolas would be used for ingress and egress training, and the Gemini 31

1964
May

mission simulator would be used for procedures and pressurized-suit, vehicle-control practice. Further training would be accomplished on the crew procedures development trainer and the flight spacecraft. MSC anticipated that the necessary equipment and development of preliminary procedures should allow a training program to begin in August 1964.

Quarterly Status Report No. 9, p. 54.

31

Gemini Program Office (GPO), encouraged by several highly successful tests, reported that all orbit attitude and maneuver system thrust chamber assembly (TCA) designs had been frozen. A 25-pound TCA tested to the 578-second mission duty cycle was still performing within specification requirements after more than 2100 seconds with a maximum skin temperature of 375°F. An 85-pound TCA accumulated 3050 seconds of mission duty cycle operation with skin temperatures no higher than 320°F. Maximum allowable for either TCA was 600°F. Two tests of the 100-pound TCA were equally successful. The first was terminated after 757 seconds of mission duty cycle operation with a maximum skin temperature of 230° to 250°F. The second ended when fuel was exhausted after 1950 seconds of mission duty cycle operation with a maximum skin temperature of 600°F. GPO attributed the success of these tests to proper injector screening techniques and reorienting the ablation material laminates from vertical to the motor housing (90°) to approximately parallel (6°), both GPO suggestions, and to the boundary-layer cooling technique suggested by Rocketdyne. In May, Rocketdyne released to production the design for the long-duration TCAs. Installation of the new long-life TCAs was planned for spacecraft No. 5, to include the 100-pound aft-firing thrusters and all 25-pound thrusters. A full complement of long-life TCAs was planned for spacecraft No. 6.

Weekly Activity Report, Mar. 29-Apr. 4, 1964, p. 4; Consolidated Activity Report, Mar. 22-Apr. 18, 1964, pp. 24-25; Quarterly Status Report No. 9, p. 9; "Gemini Propulsion by Rocketdyne," p. 5.

June
3

In cooperation with Air Force and NASA, Lockheed inaugurated the Gemini Extra Care Program to reduce the incidence of equipment failures and discrepancies resulting from poor or careless workmanship during the modification and assembly of the Agena target vehicle. The program included increased inspection, exhortation, morale boosters, special awards, and other activities aimed at fostering and maintaining a strong team spirit at all levels. Results of the program were evidenced in a drastic decline in the number of FEDRs (Failed Equipment and Discrepancy Reports) recorded in the Gemini final manufacturing area on successive vehicles.

Lockheed Agena Monthly Report, June 1964, p. 3-11; GATV Progress Report, June 1966, pp. 4-2 through 4-10; Aerospace Final Report, p. III.B-6.

4

Dynamic qualification testing of the Gemini ejection seat began with sled test No. 6 at China Lake. This was a preliminary test to prove that hatches and hatch actuators would function properly under abort conditions; no ejection was attempted. The test was successful, and qualification testing proper began on July 1 with test No. 7. The test simulated conditions of maximum dynamic pressure following an abort from the powered phase of Gemini flight, the vehicle being positioned heatshield forward as in reentry. Both seats ejected and

June
1964

all systems functioned as designed. Further sled testing was delayed by slow delivery of pyrotechnics; sled test No. 8 was not run until November 5. This test revealed a structural deficiency in the ejection seat. When the feet of one of the dummies came out of the stirrups, the seat pitched over and yawed to the left, overloading the left side panel. The panel broke off, interrupting the sequencing of the ejection system, and the seat and dummy never separated; both seat and dummy were destroyed when they hit the ground. Representatives of Manned Spacecraft Center and McDonnell met during the week of November 15 to consider revising the test program as a result of this failure. They decided to conduct test No. 9 under conditions approximating the most severe for which the ejection system was designed, in order to demonstrate the adequacy of the reworked seat structure. Test No. 9 was run on December 11, successfully demonstrating the entire ejection sequence and confirming the structural redesign. This brought the qualification sled test program to an end.

Weekly Activity Reports: June 28–July 4, p. 1; Nov. 1–7, p. 2; Nov. 15–21, p. 3; Dec. 13–19, 1964, p. 2; Consolidated Activity Reports: June 21–July 18, p. 16; Oct. 18–Nov. 30, 1964, p. 18; Quarterly Status Reports: No. 10, pp. 24–25; No. 11, p. 18; No. 12 for Period Ending Feb. 28, 1965, p. 9.

The entire complement of astronauts began launch abort training on the Ling-Temco-Vought simulator. Group 1 (selected April 1959) and Group 2 (September 1962) astronauts averaged approximately 100 runs each whereas Group 3 (October 1963) astronauts completed 32 runs apiece. The Gemini-Titan 3 launch profile was simulated in detail, including such cues as noise, vibration, pitch and roll programming, and other motion cues which results from various launch anomalies. The training was completed July 30.

8

Consolidated Activity Report, May 17–June 20, 1964, p. 30; Quarterly Status Report No. 10, p. 56.

Air Force Space Systems Division's cost-plus-fixed-fee contract with Martin for 15 Gemini launch vehicles (GLV) and associated aerospace ground equipment was replaced by a cost-plus-incentive-fee contract. Contract negotiations had been conducted between March 15 and April 30, 1964. The final contract contained cost, performance, and schedule incentives. Target cost was \$111 million and target fee was \$8.88 million. The maximum fee possible under the contract was \$16.65 million as against a minimum of \$3.33 million. The period of performance under the contract was July 1, 1963, through December 31, 1967, and covered the delivery of 14 GLVs (one GLV had already been delivered) and associated equipment and services, including checkout and launch.

10

Harris, *Gemini Launch Vehicle Chronology*, pp. 39, E-2.

Representatives of NASA, McDonnell, Weber Aircraft, and Air Force 6511th Test Group met to define the basic objectives of a program to demonstrate the functional reliability of the Gemini personnel recovery system under simulated operational conditions. Such a program had been suggested at a coordination meeting on the ejection seat system on October 30, 1963. The planned program called for the recovery system to be ejected from an F-106 aircraft, beginning with a static ground test in September, to demonstrate compatibility between the recovery system and the aircraft. Two full system tests, using a

12

1964
June

production configuration recovery system, would complete the program in about a month. The program was delayed by the unavailability of pyrotechnics. The static ground test was successfully conducted October 15, using pyrotechnics from the paraglider tow test vehicle (TTV) seat. The TTV seat pyrotechnics were adequate to demonstrate system/aircraft compatibility but lacked certain items required for full system tests. Full system testing accordingly did not begin until January 28, 1965.

Weekly Activity Report, Sept. 27–Oct. 3, 1964, p. 2; Quarterly Status Reports: No. 10, pp. 25–26; No. 11, p. 19; Abstract of Meeting on Ejection Seat System, Nov. 5, 1963.

12

Christopher C. Kraft, Jr., Assistant Director for Flight Operations, Manned Spacecraft Center, reported that three basic plans were under study for rendezvous missions. Rendezvous at first apogee would probably be rejected because of possible dispersions which might necessitate plane changes. Rendezvous

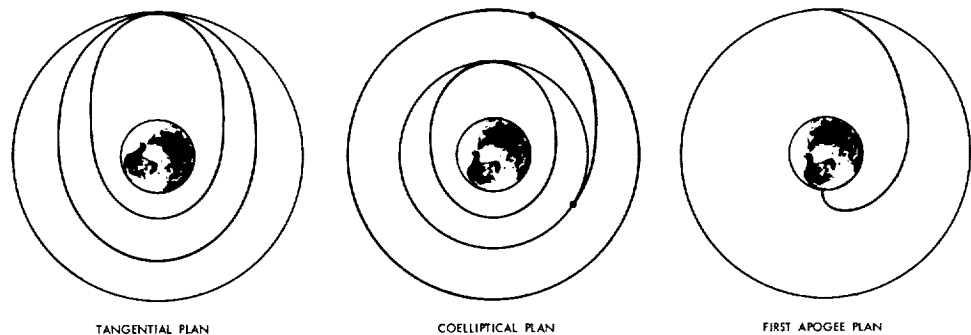

Figure 73.—The three basic rendezvous plans being considered for the first Gemini rendezvous mission. (MSC, Gemini Midprogram Conference, Including Experiment Results, NASA SP-121, 1966, p. 277.)

from concentric orbits seemed to be desirable because of the freedom in selection of the geographic position of rendezvous. Major work thus far, however, had been expended on the tangential rendezvous. Subsequently, the concentric orbit plan was chosen for Gemini-Titan 6, the first rendezvous mission.

MSC Minutes of Senior Staff Meeting, June 12, 1964, p. 3; Quarterly Status Report No. 10, p. 60.

16

Lockheed began test-firing the propulsion test vehicle assembly at its Santa Cruz Test Base, after a delay caused primarily by problems with the Agena main engine start tanks. The program, undertaken because of extensive changes in the propulsion system required to adapt the standard Agena D for use in Gemini missions, comprised three series of static-firing tests. The first series, in addition to providing base line performance for both primary and secondary propulsion systems (PPS and SPS), also subjected one SPS module to the dynamic and acoustic environment created by 55 seconds of PPS firing. The second series, successfully completed July 16, simulated a possible Gemini mission profile, including multiple firings and various coast and burn times on both PPS and SPS units. The third series, which concluded the

test program on August 7, involved a maximum number of starts and minimum-impulse firings on both PPS and SPS. All firings were successful, and review of test data revealed only minor anomalies. The entire test program comprised 27 PPS firings for a run time totaling 545 seconds, 30 SPS Unit I firings totaling 286 seconds, and 11 SPS Unit II firings totaling 268 seconds. Post-test disassembly revealed no physical damage to any equipment.

1964
June

Weekly Activity Reports: June 21-27, p. 1; Aug. 2-8, 1964, p. 1; Consolidated Activity Report, July 19-Aug. 22, 1964, p. 16; Quarterly Status Report No. 10, p. 49; Lockheed *Agna Monthly Reports: June*, p. 3-6; *July 1964*, p. 3-6; *Aerospace Final Report*, p. III.F-2.

Air Force Space Systems Division's cost-plus-fixed-fee contract with Aerojet-General for engines and related aerospace ground equipment for the Gemini launch vehicle was replaced by a cost-plus-incentive-fee contract. Contract negotiations had been conducted between May 25 and June 17, 1964. The final contract covered the procurement of 14 sets of engines (one set had already been delivered) and associated equipment during the period from July 1, 1963, through December 31, 1967. Cost, performance, and schedule incentives made possible a maximum fee of \$5,885,250 versus a minimum fee of \$1,177,050. The initial target cost was \$39,235,000 with a target fee of \$3,138,800.

17

Harris, *Gemini Launch Vehicle Chronology*, pp. 39-40, E-3.

Stage I of Gemini launch vehicle 3 was erected in the vertical test facility at Martin-Baltimore. Stage II was erected June 22. Power was first applied June 29, and subsystems functional verification testing concluded July 31.

19

Mission Report for GT-3, p. 12-25; *Aerospace Final Report*, p. II.G-3; *Gemini-Titan II Air Force Launch Vehicle*, p. D-6.

A Gemini Recovery School began operations at Kindley Air Force Base, Bermuda. Conducted by the Landing and Recovery Division of Flight Operations Directorate, this was the first such training course for Gemini offered to recovery personnel. The group included pararescue crews, Air Force navigators, and maintenance personnel.

22

MSC Space News Roundup, June 24, 1964, p. 8.

Construction of Gemini-Agena facilities at complex 14 was completed. General Dynamics finished the installation and checkout of equipment in the Launch Operations Building on July 20. Lockheed equipment in the Launch Operations Building was installed and checked out by July 31.

24

Quarterly Status Report No. 10, p. 52.

Martin-Baltimore received the propellant tanks for Gemini launch vehicle (GLV) 5 from Martin-Denver, which had begun fabrication in October 1963. Aerojet-General delivered the flight engines for GLV-5 November 5. Tank splicing was completed December 5; engine installation December 9. Final horizontal tests were completed January 7, 1965.

25

Gemini Program Mission Report, Gemini V, October 1965, p. 12-6; *Aerospace Final Report*, p. II.G-5; *Gemini-Titan II Air Force Launch Vehicle*, p. D-9.

1964
June
30

McDonnell conducted the first of two tests to qualify the spacecraft for water impact landing. Static article No. 4 was dropped from the landing system test rig heatshield forward and incurred no damage. In the second test, on July 13, the unit was dropped conical section forward. A pressure decay test of the cabin after the drop indicated a very small leak. The test unit was left in the water for two weeks and took on a pint of water, meeting qualification requirements.

Weekly Activity Report, June 28-July 4, 1964, p. 1; Quarterly Status Report No. 10, p. 7.

July
3

Following the successful mating of its modules, Gemini spacecraft No. 2 began the second phase of Spacecraft Systems Tests (SST) at McDonnell. SST continued through September. During August and September, test operations alternated with the receipt and installation of a number of flight items in the spacecraft. Vibration testing of the spacecraft and systems was successfully conducted August 20-24. No altitude chamber tests were performed on spacecraft No. 2 because the Gemini-Titan 2 mission was to be unmanned. Phase II

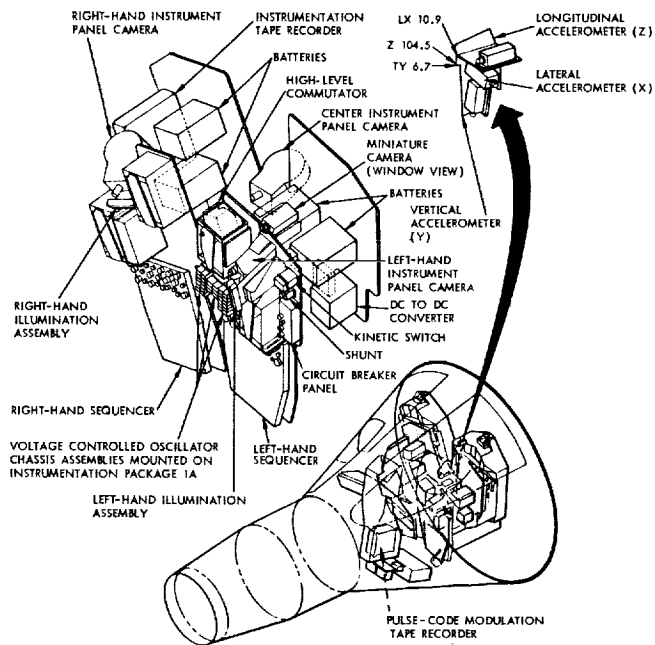

Figure 74.—Special instrumentation pallets to be installed in Gemini spacecraft No. 2 in the same positions that astronauts would occupy in later flights. (NASA Photo S-65-2263, undated.)

mated SST concluded with the Simulated Flight Test September 3-15. The spacecraft acceptance review was held September 17-18, after which it was flown to Cape Kennedy September 21.

Mission Report for GT-2, pp. 12-3, 12-4, 12-45; Consolidated Activity Report, Aug. 23-Sept. 19, 1964, p. 17; Quarterly Status Report No. 10, p. 60.

- The first design review of the extravehicular life support system chest pack was conducted. Manned Spacecraft Center conditionally approved the AiResearch basic design but recommended certain changes. 1964
July
6-12
- Abstract of Meeting on Extravehicular Activity, July 27, 1964.
- McDonnell delivered its proposal for conversion of the Gemini spacecraft contract to a cost-plus-incentive-fee contract. Manned Spacecraft Center began analysis and evaluation of the proposal. 7
- Consolidated Activity Report, June 21-July 18, 1964, p. 38; Quarterly Status Report No. 10, p. 64; Oldeg interview.
- Manager Charles W. Mathews reported that the Gemini Program Office had been reviewing and evaluating plans for Gemini-Titan (GT) missions 4 through 7. GT-4 would be a four-day mission using battery power. GT-5 would include radar and a rendezvous evaluation pod for rendezvous exercises early in the flight. The duration of this mission would be open-ended for a period of seven days, contingent upon the availability of fuel cells. GT-6 would be a standard rendezvous mission of perhaps two days' duration. GT-7 would be a long-duration mission with an open-ended potential of 14 days. George E. Mueller, NASA Associate Administrator, Office of Manned Space Flight, was currently reviewing these plans. 10
- MSC Minutes of Senior Staff Meeting, July 10, 1964, p. 4.
- Gemini launch vehicle 2 arrived at Eastern Test Range. Stage I was erected at complex 19 on July 13, stage II on July 14. Electrical power was applied to the vehicle on July 20 in preparation for Subsystems Functional Verification-Tests, which began July 21. 11
- Mission Report for GT-2, pp. 12-15, 12-48.
- Flight Crew Support Division objected to McDonnell procedures for conducting ejection seat sled tests because they were not adequate to give confidence in manned use of the seats. The dummies were being rigged with extreme restraint-harness tensions and highly torqued joints which could not be achieved with human subjects. McDonnell was requested to review the situation and prepare a report for Gemini Program Office. 16-17
- Abstract of Meeting of the GLV Panels and Coordination Committee, July 24, 1964.
- Gemini Program Office reported that tests had been conducted on section I of the fuel cells planned for the long-duration Gemini-Titan 5 mission. These tests had resulted in a failure characterized by output decay. A complete investigation was in process to determine the cause of the failure. 19-25
- Weekly Activity Report, July 19-25, 1964, p. 1.
- Astronauts James A. McDivitt and Edward H. White II were named as command pilot and pilot, respectively, for the Gemini-Titan (GT) 4 mission scheduled for the first quarter of 1965. The backup crew for the mission would be Frank Borman, command pilot, and James A. Lovell, Jr., pilot. The mission was scheduled for up to four days' duration, with 10 or 11 experiments to be performed. At a press conference on July 29 at Manned Spacecraft Center, Deputy Gemini Program Manager Kenneth S. Kleinknecht said that on 27

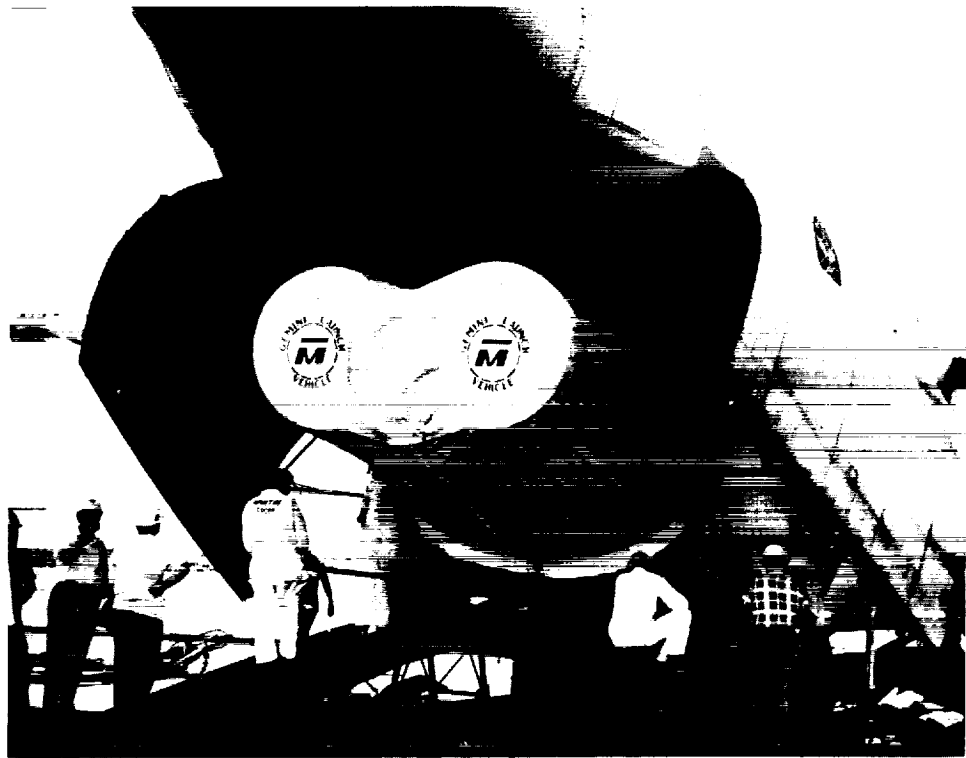

Figure 75.—The first stage of Gemini launch vehicle 2 being unloaded from an Air Force C-133 at Cape Kennedy. (KSC 64-14608, July 11, 1964.)

1964
July

the second manned space flight an astronaut would first be exposed to the hazards of outer space without full spacecraft protection. Although he first said that the experiment would involve “stepping into space,” he later modified this by saying that it might involve nothing more than opening a hatch and standing up. Other scientific experiments assigned to the GT-4 flight would include medical tests, radiation measurements, and measurement of Earth’s magnetic field.

MSC Space News Roundup, Aug. 5, 1964, p. 1; *Astronautics and Aeronautics*, 1964, p. 265.

- 27 The first meeting of the Gemini Configuration Control Board was held, and meetings were scheduled for each Monday thereafter. McDonnell’s proposal for implementation of the spacecraft configuration management system had been received by the program office and was being reviewed. Initial elements of the system were being implemented.

Weekly Activity Report, July 26–Aug. 1, 1964, p. 1.

- 29 Flight Crew Support Division personnel visited Langley Research Center for a simulation of the Gemini optical rendezvous maneuver. The simulation projected a flashing target against a background of stars inside a 40-foot diameter radome, representing the view from the command pilot station and window

port. During the demonstration, a lighted window reticle was found to be useful in the line-of-sight control task.

1964
July

Consolidated Activity Report, July 19–Aug. 22, 1964, p. 31.

North American conducted the first tow test vehicle (TTV) captive-flight test required by the Paraglider Landing System Program. A helicopter towed the TTV to 2600 feet. After about 20 minutes of total flight time, the test pilot brought the TTV to a smooth three-point landing. The tow cable was released immediately after touchdown, the wing about four seconds later. This highly successful flight was followed on August 7 by a free-flight test that was much less successful. After the TTV was towed by helicopter to 15,500 feet and released, it went into a series of uncontrolled turns, and the pilot was forced to bail out. North American then undertook a test program to isolate the malfunction and correct it, including 14 radio-controlled, half-scale TTV test flights between August 24 and December 13. Two highly successful radio-controlled, full-scale TTV free flights on December 15 and 17 justified another attempted pilot-controlled flight on December 19, with excellent results.

29

NAA, A Final Fee Settlement Proposal for Contract NAS 9-1484, p. V-49; NAA, Paraglider Landing System Program, Monthly Progress Reports: No. 15, Aug. 7; No. 16, Sept. 16, 1964; No. 20, Jan. 15, 1965.

In response to a request from NASA Headquarters, Gemini Program Office (GPO) provided a study for Gemini missions beyond the 12 originally planned. "The Advanced Gemini Missions Conceptual Study" described 16 further missions, including a space station experiment, a satellite chaser mission, a lifeboat rescue mission, and both a circumlunar and lunar orbiting mission. On February 28, 1965, GPO reported that a preliminary proposal for Gemini follow-on missions to test the land landing system had not been approved. Spare Gemini launch vehicles 13, 14, and 15 were canceled, and there were no current plans for Gemini missions beyond the approved 12-flight program.

30

Memo, Manager, Gemini Program, to NASA Hq., Attn: W. C. Schneider, Subj: Advanced Gemini Missions, with enc., Sept. 18, 1964; Quarterly Status Report No. 12, p. 40.

Manned Spacecraft Center Propulsion and Power Division conducted a test of the Gemini fuel cell. The system was inadvertently operated for 15 minutes during a short circuit prior to the scheduled test. System performance was poor, and two of the cells would not carry loads of six amperes. The test was terminated. The product water sample obtained from the test was extremely acidic, indicating a potential membrane failure.

August
4-6

Consolidated Activity Report, July 19–Aug. 22, 1964, p. 77.

The formal Combined Systems Acceptance Test (CSAT) of Gemini launch vehicle (GLV) 3 was successfully performed. The vehicle acceptance team (VAT) met August 17 to review CSAT and other test and manufacturing data. Because GLV-3 was not yet needed at the Cape, Manned Spacecraft Center, in line with Aerospace recommendations, decided to have all engineering changes installed at Baltimore instead of at the Cape. After reviewing these modifications, the VAT directed Martin to conduct a second CSAT when

7

1964
August

they were completed. Modifications were completed September 15; subsystems retest was finished September 28, and the second CSAT was completed September 30.

Mission Report for GT-3, p. 12-25; Weekly Activity Reports: Aug. 23-29, p. 1; Sept. 27-Oct. 3, 1964, p. 1; Consolidated Activity Report, July 19-Aug. 22, 1964, p. 16; Quarterly Status Report No. 10, p. 43; letter, Bernhard A. Hohmann to Grimwood, Aug. 16, 1967; Aerospace *Final Report*, p. II.G-3; *Gemini-Titan II Air Force Launch Vehicle*, p. D-7; Harris, *Gemini Launch Vehicle Chronology*, p. 41.

- 14 At a meeting of the NASA-McDonnell Management Panel, the problem of the extravehicular activity (EVA) chest pack size was discussed. If stowed on spacecraft No. 6, it would take up space that would otherwise be available for experiments on that mission, and the same would be true on subsequent missions. A study was requested from McDonnell, as well as suggestions for alternative plans. One such alternative proposed was the storing of some experiments in the adapter section—but this, of course, meant that EVA would be a prerequisite for those experiments.

Minutes, NASA-MAC Management Panel, at McDonnell, Aug. 14, 1964.

- 16 Martin-Baltimore received the propellant tanks for Gemini launch vehicle 6 from Martin-Denver, which had begun fabricating them in April. After being inspected, the tanks were placed in storage where they remained until December 18.

Gemini Program Mission Report, Gemini VI-A, January 1966, p. 12-7; Aerospace *Final Report*, p. II.G-5; *Gemini-Titan II Air Force Launch Vehicle*, p. D-11.

- 17 A severe electrical storm in the vicinity of complex 19 interrupted testing of Gemini launch vehicle (GLV) 2. Several observers reported a lightning strike at or near complex 19. All testing was halted for a thorough investigation of this so-called electromagnetic incident. The inspection, completed on September 2, revealed no physical markings of any kind but disclosed a number of failed components, mostly in aerospace ground equipment (AGE) with some in GLV-2. This indicated that complex 19 had not been hit directly; damage was attributed to the electromagnetic effects of a nearby lightning strike or to resulting static charges. A recovery plan was prepared to restore confidence in all launch vehicle systems, AGE, ground instrumentation equipment, and facility systems. All components containing semiconductors were replaced, and all tests were to be conducted again as if GLV-2 had just arrived at Eastern Test Range.

Mission Report for GT-2, pp. 12-15, 12-16, 12-48; briefing to Gemini Executive Management Meeting, Sept. 4, 1964; Aerospace *Final Report*, pp. II.E-14, II.E-15; Harris, *Gemini Launch Vehicle Chronology*, p. 41.

- 22 Manned Spacecraft Center (MSC) Procurement and Contracts Division reported that the amendment to the Gemini flight suit contract covering G3C flight suits and related equipment for Gemini-Titan (GT) 3 had been sent to the contractor, David Clark Company. The first four Gemini flight suits, to be used in GT-3, were delivered to MSC late in August. Because of earlier problems in fitting training suits, astronauts had had preliminary fittings of the flight suits before final delivery.

Consolidated Activity Reports: July 19–Aug. 22, p. 42; Aug. 23–Sept. 19, 1964, p. 50; Quarterly Status Report No. 10, p. 27.

1964
August

Crew Systems Division reported that AiResearch had been formally notified to begin immediately integrating displays and associated circuitry for the astronaut Modular Maneuvering Unit (MMU) into the basic design of the extravehicular life support system (ELSS). The MMU was scheduled to be flown in Gemini-Titan 9 as Department of Defense experiment D-12. The first prototype ELSS was scheduled for delivery in January 1965.

22

Consolidated Activity Report, July 19–Aug. 22, 1964, p. 52; Quarterly Status Report No. 10, p. 28.

Flight Crew Support Division reported that egress and recovery training for the first manned Gemini flight crew had been defined and scheduled in three phases: phase I would consist of an egress procedure review in the McDonnell Gemini mock-up, phase II of a review of egress development results and of egress using the trainer and the Ellington flotation tank, and phase III of egress in open water with the essential recovery forces.

22

Consolidated Activity Report, July 19–Aug. 22, 1964, p. 31.

Hurricane Cleo struck the Cape Kennedy area. Stage II of Gemini launch vehicle (GLV) 2 was deerected and stored; the erector was lowered to horizontal, and stage I was lashed in its vertical position. Stage II was reerected September 1. Power was applied to the launch vehicle September 2, and Subsystem Functional Verification Tests (SSFVT) began September 3. When forecasts indicated that Hurricane Dora would strike Cape Kennedy, both stages of GLV-2 were deerected on September 8 and secured in the Missile Assembly Building. Hurricane Ethel subsequently threatened the area, and both stages remained in the hangar until September 14, when they were returned to complex 19 and reerected. SSFVT, begun again on September 18, ended successfully October 5.

27

Mission Report for GT-2, pp. 12-16, 12-48; *Gemini-Titan II Air Force Launch Vehicle*, p. D-5; Harris, *Gemini Launch Vehicle Chronology*, p. 42.

Manned Spacecraft Center reported that efforts were still being made to clarify production problems at Ordnance Associates, Pasadena, California, pyrotechnics contractor for the Gemini program. The problems appeared to be more extensive than had been previously indicated. Problems of poor planning or fabrication and testing were complicated by poor quality control. In many areas it was difficult to trace the routing of parts. These problems were caused by inadequate record-keeping and frequent by-passing of checkpoints by development engineers who were trying to expedite the release of parts for test programs. Efforts to solve these difficulties stopped production for a time and delayed the overall program.

31

Quarterly Status Report No. 10, pp. 19, 20.

Gemini Program Office (GPO) reported the substantial completion of all research and development testing of components, including thrust chamber assemblies, of the reentry control system (RCS) and orbit attitude and maneuver system (OAMS) as configured for spacecraft Nos. 2 through 5. System testing of two RCS units was under way, and GPO expected the test program

31

1964
August

to be finished by the end of 1964. Research and development system testing of the OAMS configuration for spacecraft Nos. 2 through 5 was expected to be completed within three months, but no plans had yet been approved for tests of the spacecraft No. 6 configuration. The long delay in completing research and development testing had resulted in serious delays in the qualification test program. GPO reviewed the qualification test program to see how schedules could be improved without compromising the attainment of test data. Some test requirements were deleted, but the major change was reducing hardware requirements by planning more tests on single units. Since lack of hardware had been a major source of delay, GPO expected this change to produce improved schedules. Reliability testing was to be done on some qualification hardware, which meant that much of the reliability test program could not be initiated until qualification testing was finished.

Quarterly Status Report No. 10, pp. 11-12.

September
4

Air Force Space Systems Division (SSD), supported by launch vehicle contractors, recommended that Gemini launch vehicle (GLV) 2 be flown as scheduled. Manned Spacecraft Center had proposed dropping GLV-2 from the Gemini program because of possible ill effects resulting from the electromagnetic incident of August 17 and from Hurricane Cleo. GLV-3 would then be substituted for the second Gemini mission, and the program would be shortened by one flight. After reviewing the incidents, their effects, corrective action, and retesting, SSD, Martin, Aerospace, and Aerojet-General all felt GLV-2 should fly, and NASA accepted their recommendation.

Briefing to Gemini Executive Management Meeting, Sept. 4, 1964; Harris, *Gemini Launch Vehicle Chronology*, p. 42; interview, Lt. Col. F. M. Hutchison, Los Angeles, Apr. 19, 1966.

- 8 McDonnell began final checkout and control system calibration tests of the Gemini translation and docking simulator. Engineering data runs for the control system evaluation tests of the simulator began September 12 and lasted two weeks. All testing was expected to be completed by late October when crew training would begin.

Consolidated Activity Reports: Aug. 23-Sept. 19, p. 31; Sept. 20-Oct. 17, 1964, pp. 30-31.

- 13 Final mating of Gemini spacecraft No. 3 modules began at McDonnell. Mating operations were completed September 27. In the meantime, the second phase of Spacecraft Systems Tests (SST) began. Vibration testing was accomplished November 7-8, and altitude chamber tests began November 12. During the manned portion of altitude tests, space suits for the Gemini-Titan 3 prime and backup crews were satisfactorily checked out, with no significant problems (November 15-19). The Simulated Flight Test (December 6-21) completed SST. After spacecraft acceptance review on December 22, it was shipped to Cape Kennedy January 3, 1965.

Mission Report for GT-3, pp. 12-21, 12-22; Weekly Activity Reports: Nov. 8-14, p. 1; Nov. 15-21, 1964, p. 1; Quarterly Status Report No. 11, p. 20.

- 21 Spacecraft No. 2 arrived at Cape Kennedy and was installed in the Cryogenic Building of the Merritt Island Launch Area Fluid Test Complex. There it

1964
September

was inspected and connected to aerospace ground equipment (AGE), and hypergolic and cryogenic servicing was performed. Reentry control and orbit attitude and maneuver systems engines were static fired October 4-5. The spacecraft was moved to the Weight and Balance Building on October 10 for pyrotechnic buildup and installation of seats and pallets, completed October 17. The following day it was transferred to complex 19 and prepared for mating with Gemini launch vehicle 2. Premate systems testing was conducted October 21-27. Premate Simulated Flight Test was completed November 4.

Mission Report for GT-2, pp. 12-4 through 12-6, 12-46; Consolidated Activity Report, Sept. 20-Oct. 17, 1964, p. 74.

Manned Spacecraft Center announced at a Trajectories and Orbits Panel meeting that several changes in the ground rules had been made to the Gemini-Titan 6 mission plan. One change concerned a previous assumption of a 20-day Agena lifetime; it was now established that the Agena would not be modified to provide this. As a result, greater emphasis had to be placed on ensuring spacecraft launch on the same day as the Agena, primarily by relieving the constraint of no Agena maneuvers. The restriction on using Agena maneuvers had been removed to increase the probability of achieving rendezvous within the few days that the Agena would remain an acceptable target.

Abstract of Meeting on Trajectories and Orbits, Oct. 20, 1964.

Lockheed completed the modification and final assembly of Gemini Agena target vehicle 5001 and transferred it to systems test complex C-10 at the Lockheed plant. Lockheed began the task of hooking the vehicle up for systems testing the next day, September 25.

Consolidated Activity Report, Sept. 20-Oct. 17, 1964, p. 17; Aerospace *Final Report*, p. III.G-3; *GATV Progress Report*, September 1964, pp. 2-3, 2-4.

Representatives from the Instrumentation and Electronics Division conducted preliminary rendezvous radar flight tests at White Sands Missile Range. Testing was interrupted while the T-33 aircraft being used was down for major maintenance and was then resumed on October 19. Flight testing of the rendezvous radar concluded December 8.

Weekly Activity Report, Dec. 6-12, 1964, p. 4; Consolidated Activity Report, Sept. 20-Oct. 17, 1964, pp. 57-58.

Gemini Program Manager Charles W. Mathews presented the Gemini Management Panel with the new flight schedule resulting from the lightning strike and hurricane conditions. The schedule was as follows: Gemini-Titan (GT) 2, November 17; GT-3, January 30, 1965; and GT-4, April 12. For GT-4 through GT-7, three-month launch intervals were planned; for the remainder of the program, these intervals would be reduced to two and one half months.

Minutes of Project Gemini Management Panel Meeting held at Patrick AFB, Fla., Sept. 29, 1964.

Fuel cells and batteries were discussed as power sources for the Gemini-Titan (GT) 5 mission (long-duration) at a meeting of the Gemini Management Panel. A study was reviewed that proposed a combination to be used in the following manner: batteries would be used during peak load requirements; the fuel cell

1964
September

would supply the remaining mission power source requirements. The panel accepted the proposal, and McDonnell was directed to proceed with the plan. In addition, the group decided to remove the fuel cell from GT-4 and substitute batteries, pending the concurrence of NASA Headquarters. It also decided to fly older versions of the fuel cell in GT-2 (the redesigned version would be flown in the later manned flights) to gain flight experience with the component.

Minutes of Project Gemini Management Panel Meeting, Sept. 29, 1964.

30

Manned at-sea tests of the Gemini spacecraft, using static article No. 5, began. During the two days of tests, spacecraft postlanding systems functioned satisfactorily, but the two crew members were uncomfortable while wearing their pressure suits. The comfort level was improved by removing the suits, but cabin heat and humidity levels were high. The test was stopped after 17 hours by the approach of Hurricane Hilda. A test to determine if opening the hatch would

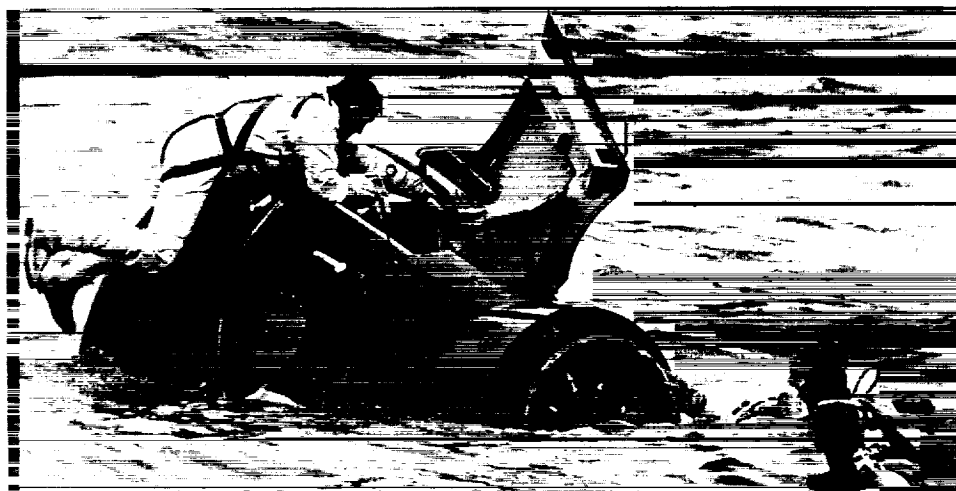

Figure 76.—At-sea egress training in Galveston Bay. (NASA Photo No. 65-H-641, released Apr. 14, 1965.)

alleviate the heat and humidity problem was conducted November 13; temperature did fall, enhancing comfort of the test subjects. Three days later an at-sea test demonstrated water egress procedure. The astronauts left the spacecraft and were able to close and latch the hatch behind them, indicating that the reentry vehicle could be recovered even if the astronauts had to leave it.

Weekly Activity Report, Nov. 15-21, 1964, p. 3; Quarterly Status Report No. 11, pp. 16-17.

During
the
month

Early in the month, Bell Aerosystems began a test program to identify the cause of the failure of the secondary propulsion system (SPS) Unit II thrust chamber during Preliminary Flight Rating Tests. The wall of the thrust chamber had burned through near the injector face before attaining the specification accumulated firing time of 400 seconds. Six series of tests, each comprising three 50-second firings separated by 30-minute coast periods, were planned, with the temperature range of fuel and oxidizer varied for each series. Originally

planned for completion in two weeks, the test program was delayed by test cell problems and did not end until mid-November. Only four test series were actually run, but they were enough to establish that the chamber wall burned through when both fuel and oxidizer were at elevated temperatures (above 100°F) and only when burn time approached 50 seconds. Gemini Project Office concluded that no mission problem existed because Lockheed's analysis of SPS operation indicated that the maximum propellant temperature range in orbit was 0° to 85°F, including a 30°F margin. (Nominal temperature range was 30° to 55°F.)

1964
September

Weekly Activity Reports: Sept. 6-12, p. 1; Nov. 8-14, 1964, p. 2; Consolidated Activity Report, Aug. 23-Sept. 19, 1964, p. 16; Quarterly Status Report No. 11, p. 39; Abstracts of Meetings on Atlas/Agena Coordination, Aug. 27, Sept. 15, 1964; *GATV Progress Reports*: September, pp. 2-1, 2-2; October, p. 2-2; November 1964, pp. 2-2, 2-3.

The Prespacecraft Mate Combined Systems Test (CST) of Gemini launch vehicle 2 was completed at complex 19. This test, similar to CST performed at the Martin plant, comprised an abbreviated countdown and simulation of flight events, with a simulator representing electrical characteristics of the spacecraft; its purpose was to establish confidence in the launch vehicle. Electrical-Electronic Interference Tests were completed October 12. Hurricane Isbell threatened the area on October 14-15, but its path was far enough south of the Cape to make deerection unnecessary, though testing was curtailed.

October
6

Mission Report for GT-2, pp. 12-16, 12-48; Aerospace *Final Report*, p. II.F-3; *Gemini-Titan II Air Force Launch Vehicle*, p. 4-14; interview, Edward F. Mitros, Houston, Oct. 2, 1967.

The vehicle acceptance team for Gemini launch vehicle (GLV) 3 met for the second time to review test and manufacturing data at Martin-Baltimore. The

7

Figure 77.—Gemini launch vehicle 3 undergoing final checks before roll-out inspection. (Martin Photo No. B-70503, undated.)

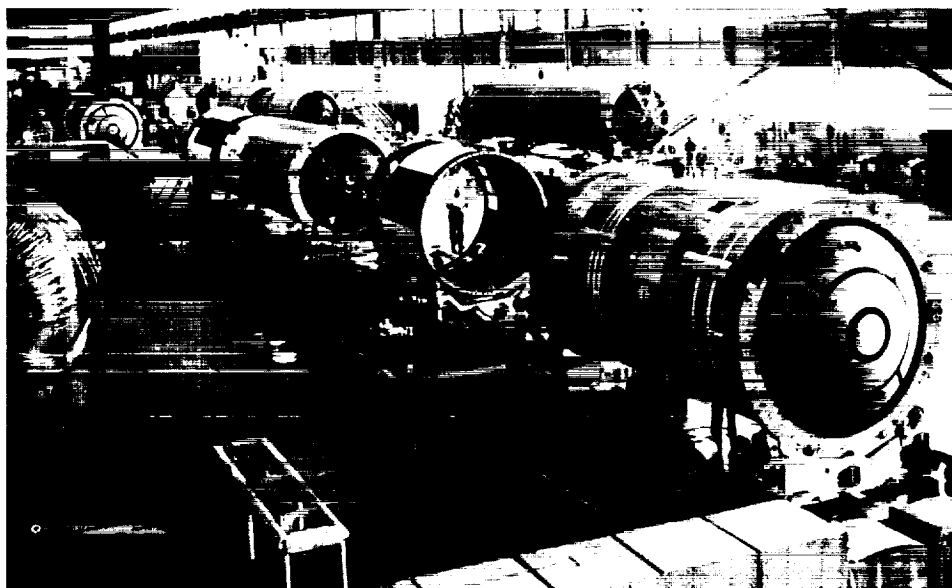

1964
October

meeting concluded on October 9 with the vehicle found acceptable and Martin was authorized to remove it from the vertical test cell. After final checks, weighing, and balancing, GLV-3 passed roll-out inspection on October 27 and was turned over to the Air Force. Air Force Space Systems Division formally accepted GLV-3, following a review of launch vehicle status and correction of discrepancy items.

Mission Report for GT-3, p. 12-25; *Aerospace Final Report*, p. II.G-3; *Gemini-Titan II Air Force Launch Vehicle*, p. D-7; Harris, *Gemini Launch Vehicle Chronology*, p. 43.



Figure 78.—Backup and prime crews for Gemini-Titan 3 mission at Gemini launch vehicle 3 roll-out inspection. Left to right: Thomas P. Stafford, Walter M. Schirra, Jr., John W. Young, and Virgil I. Grissom. (NASA Photo No. 64-H-2598 [Gemini], Oct. 28, 1964.)

9-17

First major tests of the NASA worldwide tracking network were conducted in preparation for manned orbital flights in the Gemini program. Simulated flight missions were carried out over nine days and involved Goddard Space Flight Center, Mission Control Center at the Cape, and eight remote sites in the worldwide network to test tracking and communications equipment, as well as flight control procedures and equipment. This completed the updating of the Manned Space Flight Tracking Network to support the Gemini flights. Converting the Mercury network for Gemini had taken two years and cost \$50 million.

Material compiled by Alfred Rosenthal, Deputy Chief, Office of Public Affairs, Goddard Space Flight Center.

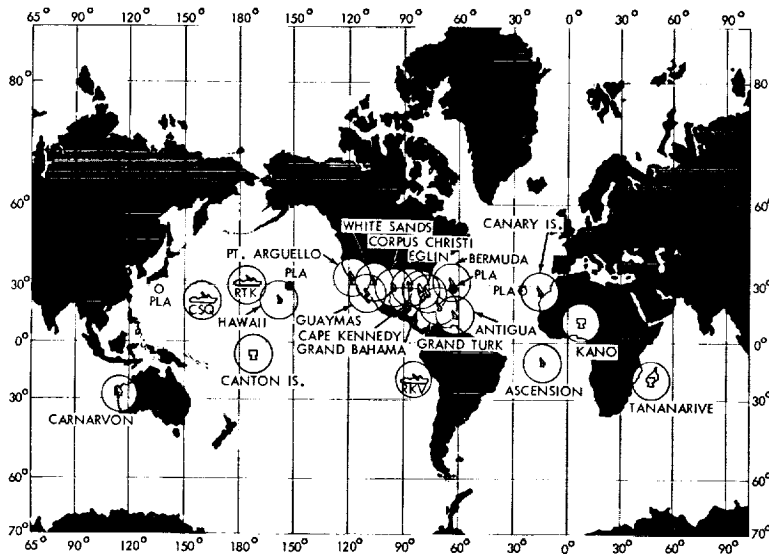

Figure 79.—The Gemini Network. See Appendix 4 tabulation of equipment at each site. (NASA Photo S-65-4007, undated.)

Gemini Program Office reported that the first production rendezvous radar, intended for spacecraft No. 5, had completed its predelivery acceptance tests.

Weekly Activity Report, Oct. 4-10, 1964, p. 1.

1964
October
10

McDonnell completed final assembly and systems tests of Gemini spacecraft No. 3A and delivered it to the laboratory for thermal balance testing. Spacecraft No. 3A had been designated a thermal qualification test unit. All of its systems and subsystems were flightworthy, with the exception of certain easily replaceable pieces of equipment such as the heatshield and ejection seats for which non-flight articles were substituted with NASA approval. Qualification testing comprised mission simulations in the altitude chamber, with all systems being operated to their duty cycles. During the next two months, the spacecraft was installed in the altitude chamber, completed a dry run test, and was accepted after a readiness review meeting. Thermal qualification testing began December 19.

15

Quarterly Status Report No. 11, pp. 2, 50; McDonnell *Final Report*, pp. 32-33.

Flight Crew Support Division reported that the Gemini-Titan (GT) 3 primary crew had completed egress practice in boilerplate No. 201 in the Ellington Air Force Base flotation tank. The backup GT-4 crew was scheduled for such training on October 23. Full-scale egress and recovery training for both the GT-3 and the GT-4 crews was scheduled to begin about January 15, when parachute refresher courses would also be scheduled.

17

Consolidated Activity Report, Sept. 20-Oct. 17, 1964, p. 32.

Crew Systems Division reported that the first Gemini extravehicular prototype suit had been received from the contractor and assigned to Astronaut James A.

17

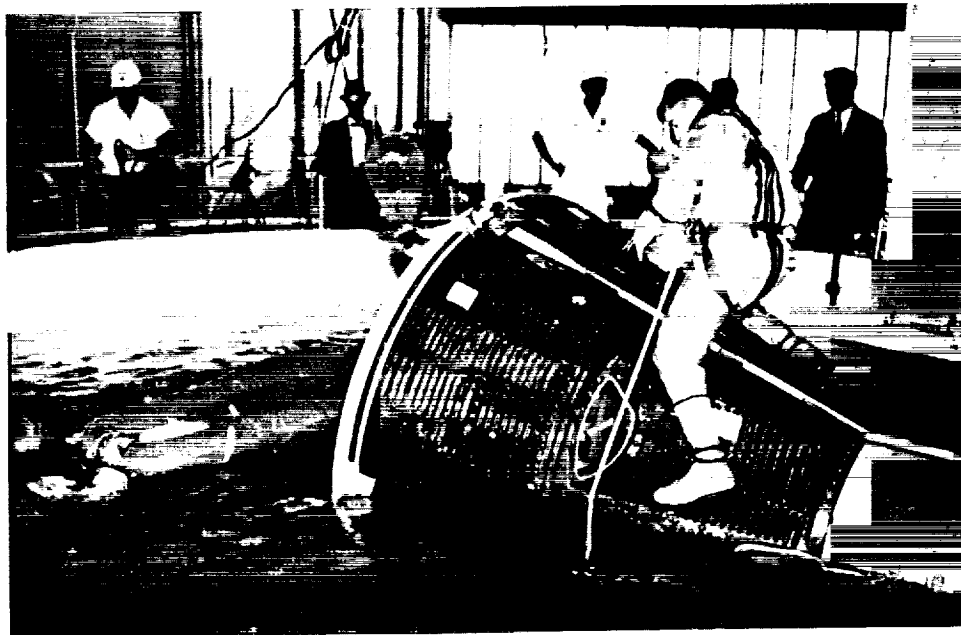

Figure 80.—Water egress training in the flotation tank at Ellington Air Force Base, Texas. (NASA Photo S-65-2503, Feb. 5, 1965.)

1964
October

McDivitt for evaluation in the Gemini mission simulator. During the test, McDivitt complained of some bulkiness and immobility while the suit was in the unpressurized condition, but the bulk did not appear to hinder mobility when the suit was pressurized. The thermal/micrometeoroid cover layer had been installed on a test suit sent to Ling-Temco-Vought for thermal testing in the space simulator chamber.

Consolidated Activity Report, Sept. 20–Oct. 17, 1964, p. 47.

- 17 Crew Systems Division reported that zero-g tests had been conducted at Wright-Patterson Air Force Base to evaluate extravehicular life support system ingress techniques. Results showed that, after practice at zero g, subjects wearing the chest pack had successfully entered the spacecraft and secured the hatch in approximately 50 seconds.

Consolidated Activity Report, Sept. 20–Oct. 17, 1964, p. 47.

- 26 Russell L. Schweickart spent eight days in a Gemini space suit to evaluate Gemini biomedical recording instruments. While in the suit, the astronaut flew several zero-g flight profiles, went through a simulated four-day Gemini mission, and experienced several centrifuge runs.

Weekly Activity Report, Oct. 18–24, 1964, p. 1; MSC *Space News Roundup*, Oct. 28, 1964, p. 8.

- 28 Gemini launch vehicle 4 was erected in the vertical test facility at Martin-Baltimore. Power was applied to the vehicle for the first time on November 4. Subsystems Functional Verification Tests were completed November 19.

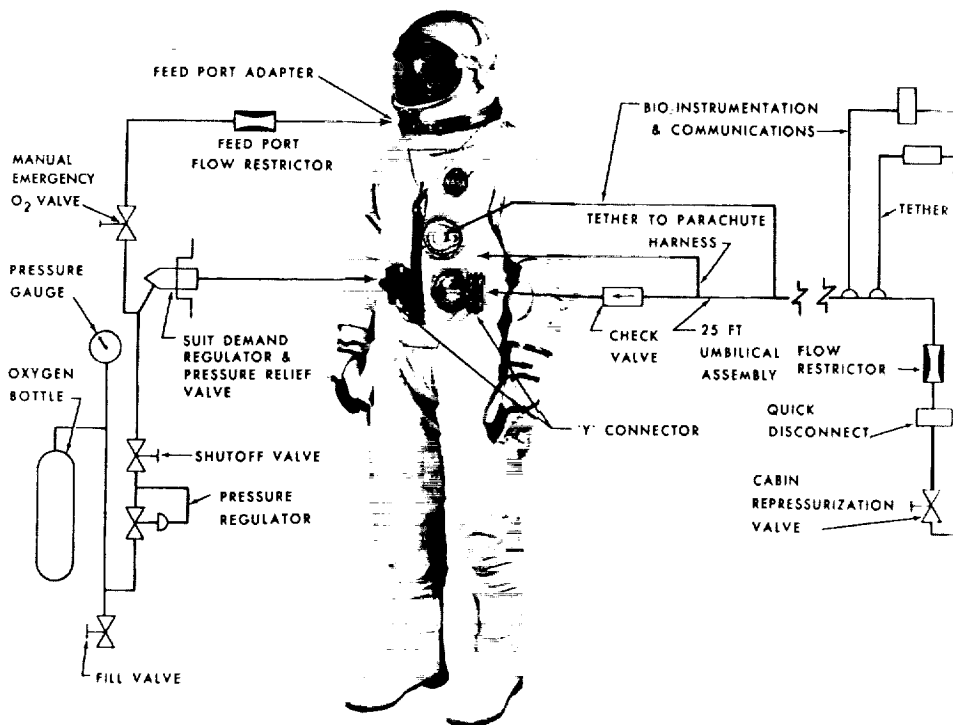

Figure 81.—Diagram of the Gemini G4C extravehicular suit. (NASA Photo S-65-4858, May 1965.)

Mission Report for GT-IV, p. 12-26; Aerospace Final Report, p. II.G-5; Gemini-Titan II Air Force Launch Vehicle, p. D-8.

1964
October

Bell Aerosystems successfully fired the Agena secondary propulsion system (SPS) in a test of the system's ability to survive a launch hold. The SPS had first gone through a 20-day dry (unloaded) period, followed by a 20-day wet (loaded) period. The system reverted to hold condition and was successfully refired November 2.

28

GATV Progress Reports: October, p. 2-2; November 1964, p. 2-2.

Gemini launch vehicle 2 and spacecraft No. 2 were mechanically mated at complex 19. The Electrical Interface Integrated Validation, confirming compatibility between launch vehicle and spacecraft and checking out redundant circuits connecting the interface, was completed November 9. This was followed by the Joint Guidance and Control Test, completed November 12, which established proper functioning of the secondary guidance system, comprising the spacecraft inertial guidance system and the launch vehicle's secondary flight control system.

November
5

Mission Report for GT-2, pp. 12-17, 12-49; Aerospace Final Report, p. II.F-3.

The Gemini mission simulator at the Cape, configured in the spacecraft No. 3 version, became operational; during the next three weeks, some 40 hours of

9



Figure 82.—Norman Shyken, McDonnell engineer-pilot, in zero-g tests in an Air Force KC-135 jet transport. (NASA Photo S-64-23051, May 25, 1964.)

1964
November

flight crew usage and three hours of other Manned Spacecraft Center personnel usage were logged.

Consolidated Activity Report, Oct. 18–Nov. 30, 1964, p. 29.

- 10 Gemini Agena target vehicle (GATV) 5001 completed a simulated flight (ascent and orbit) at Lockheed test complex C-10. Minor anomalies required portions of the test to be rerun. This concluded GATV 5001 systems tests in preparation for captive-firing tests to be conducted at Lockheed's Santa Cruz Test Base. The vehicle was shipped November 30.

Quarterly Status Report No. 11, pp. 4, 37; *GATV Progress Report*, November 1964, pp. 2-3, 2-5, 7-8.

- 17 Gemini launch vehicle 2 and spacecraft No. 2 were electrically mated at complex 19. The Joint Combined Systems Test was run the following day. This was the first test of launch vehicle and spacecraft combined systems. It consisted of an abbreviated countdown and two plus-time flight simulations, one to exercise the primary guidance system, the second to exercise the secondary system. A second combined systems test, the Flight Configuration Mode Test (FCMT), was completed November 21 in preparation for the Wet Mock Simulated Launch. FCMT was essentially similar to other combined systems tests except that all umbilicals were dropped.

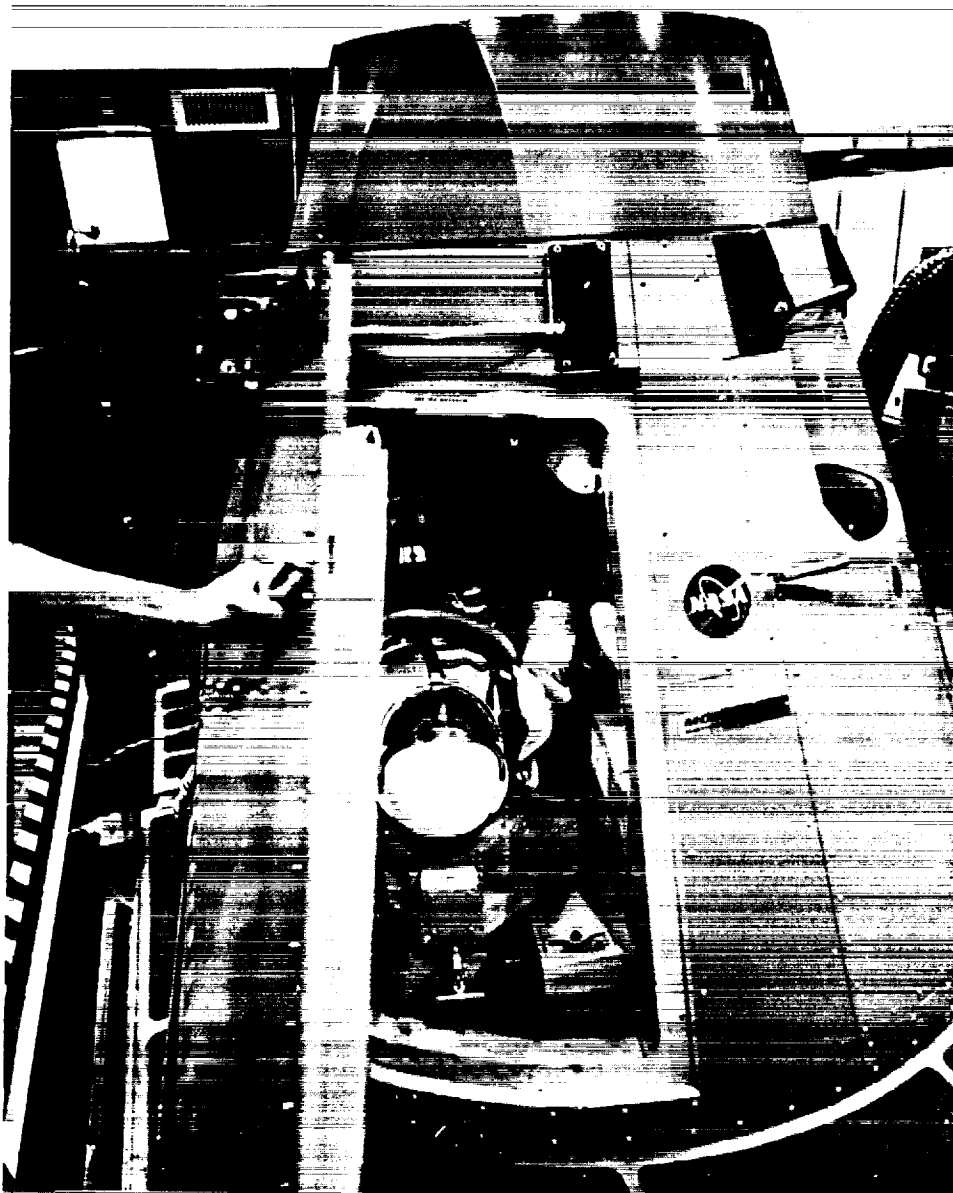

(A)

Figure 83(A).—Astronauts Grissom and Young in the Gemini mission simulator at Cape Kennedy prior to the Gemini-Titan 3 mission. (NASA Photo No. 65-H-415, released Mar. 19, 1965.)

Mission Report for GT-2, pp. 12-17, 12-49; Aerospace *Final Report*, p. II.F-3; *Gemini-Titan II Air Force Launch Vehicle*, pp. 4-14, 4-16.

1964
November

Gemini-Titan (GT) 2 successfully completed the Wet Mock Simulated Launch, a full-scale countdown exercise which included propellant loading. Procedures for flight crew suiting and spacecraft ingress were practiced during simulated

24



(B)

Figure 83(B).—Technicians at the mission simulator console. (NASA Photo No. 65-H-416, released Mar. 19, 1965.)

1964
November

launch. The primary Gemini-Titan 3 flight crew donned the training suits and full biomedical instrumentation, assisted by the space suit bioinstrumentation and aeromedical personnel who would participate in the GT-3 launch operation. As a result of this practice operation, it was established that all physical examinations, bioinstrumentation sensor attachment, and suit donning would be done in the pilot ready room at complex 16. The final readi-

1964
November

ness of the vehicle for flight was established by the Simulated Flight Test on December 3. For the launch vehicle, this test was a repeat of the Joint Combined Systems Test, but for the spacecraft it was a detailed mission simulation.

Mission Report for GT-2, p. 12-17; Quarterly Status Report No. 11, p. 20; Aerospace *Final Report*, pp. IIF-3, IIF-4; *Gemini-Titan II Air Force Launch Vehicle*, p. 4-18.

Gemini launch vehicle (GLV) 3 was scheduled to be shipped from Martin-Baltimore to Cape Kennedy. Shipment was delayed, however, because GLV-2 had not yet been launched; and several modifications, scheduled for the Cape, were made at Baltimore instead. All work was completed by January 14, 1965; the vehicle was reinspected and was again available for delivery. Preparations for shipment were completed January 20, and stage II was airlifted to Cape Kennedy January 21, followed by stage I January 23.

24

Mission Report for GT-3, p. 12-25; Aerospace *Final Report*, p. IIG-3; *Gemini-Titan II Air Force Launch Vehicle*, p. D-7.

The Combined Systems Acceptance Test of Gemini launch vehicle (GLV) 4 was conducted. The vehicle acceptance team inspected the vehicle and reviewed all test and manufacturing data December 11-13 and authorized Martin to remove GLV-4 from the vertical test cell. During the next three months, while awaiting shipment to Cape Kennedy, GLV-4 had 27 engineering changes installed. Final integrity checks, weighing, and balancing were completed March 8, 1965.

25

Mission Report for GT-IV, p. 12-26; Aerospace *Final Report*, p. IIG-5; *Gemini-Titan II Air Force Launch Vehicle*, pp. D-8, D-9.

Lockheed shipped Gemini Agena target vehicle (GATV) 5001 to its Santa Cruz Test Base for captive-firing tests. Primary test objective was verifying the operational capabilities of the GATV during actual firing of the primary and secondary propulsion systems. Other objectives included developing operational procedures and techniques for vehicle handling, launch preparation, servicing, countdown, and postfire servicing, as well as verifying ground equipment peculiar to the Gemini program, including the pulse-code-modulated telemetry ground station. The target docking adapter (TDA), manufactured by McDonnell, was also to be installed and tested as an integral system. When the TDA was hoisted into the test stand on December 17 to be physically mated with the GATV, the interface between the two vehicles emerged as a major problem. After some preliminary difficulties, the physical mate was accomplished, but discrepancies were discovered in wiring continuity. The captive flight test was delayed until January 20, 1965.

30

Consolidated Activity Report, December 1964, p. 14; Aerospace *Final Report*, p. IIIF-2; *GATV Progress Report*, December 1964, pp. 2-1, 2-3, 2-5.

Astronauts James McDivitt and Edward White, command pilot and pilot for the Gemini-Titan 4 mission, began crew training on Gemini mission simulator No. 2 in Houston. The initial week of training was devoted to familiarizing the crew with the interior of the spacecraft.

30

Weekly Activity Report, Dec. 6-12, 1964, p. 3.

PROJECT GEMINI: A CHRONOLOGY

1964
December
1

Roll-out inspection and delivery of the first Atlas standard launch vehicle (SLV-3) for the Gemini program was completed at the General Dynamics/Convair plant in San Diego. Originally scheduled for November 23, inspection had been delayed by the discovery of scored fuel and oxidizer lines. After being accepted by the Air Force, the vehicle was shipped by truck to Eastern Test Range, where it arrived on December 7.

Weekly Activity Reports: Nov. 29-Dec. 5, p. 3; Dec. 6-12, 1964, p. 4; Consolidated Activity Report, Oct. 18-Nov. 30, 1964, p. 17.

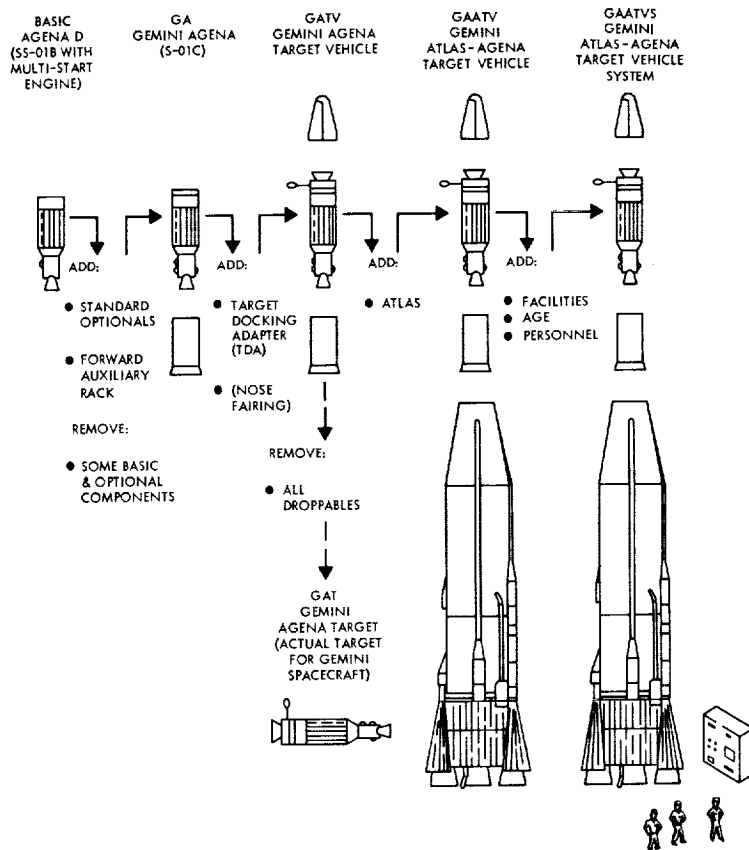

Figure 84.—Terminology for the Gemini Agena target vehicle program. (Lockheed, Gemini Agena Target Press Handbook, LMSC A766871, Feb. 15, 1966, p. 1-1.)

3

NASA advised North American that no funds were available for further flight testing in the Paraglider Landing System Program, following completion of full-scale test vehicle flight test No. 25. NASA did authorize North American to use the test vehicles and equipment it had for a contractor-supported flight test program. North American conducted a two-week test program which culminated in a highly successful manned tow-test vehicle flight on December 19.

NAA, A Final Fee Settlement Proposal for Contract NAS 9-1484, Section III; Paraglider Landing System, Monthly Progress Reports: No. 20, Jan. 15; No. 21, Feb. 11, 1965.

A four-day comfort test of the Gemini space suit was started as part of the suit qualification test program. The test utilized a human volunteer and ended successfully on December 11. The suited subject used Gemini food and bio-instrumentation and the Gemini waste management systems hardware.

1964
December
7

Consolidated Activity Report, December 1964, p. 45.

Gemini-Titan (GT) 2 launch countdown began at 4:00 a.m., e.s.t., and proceeded normally, with minor holds, until about one second after engine ignition. At that point a shutdown signal from the master operations control set (MOCS) terminated the launch attempt. Loss of hydraulic pressure in the primary guidance and control system of stage I of the launch vehicle caused an automatic switchover to the secondary guidance and control system. During the 3.2-second holddown following ignition command, switchover was

9

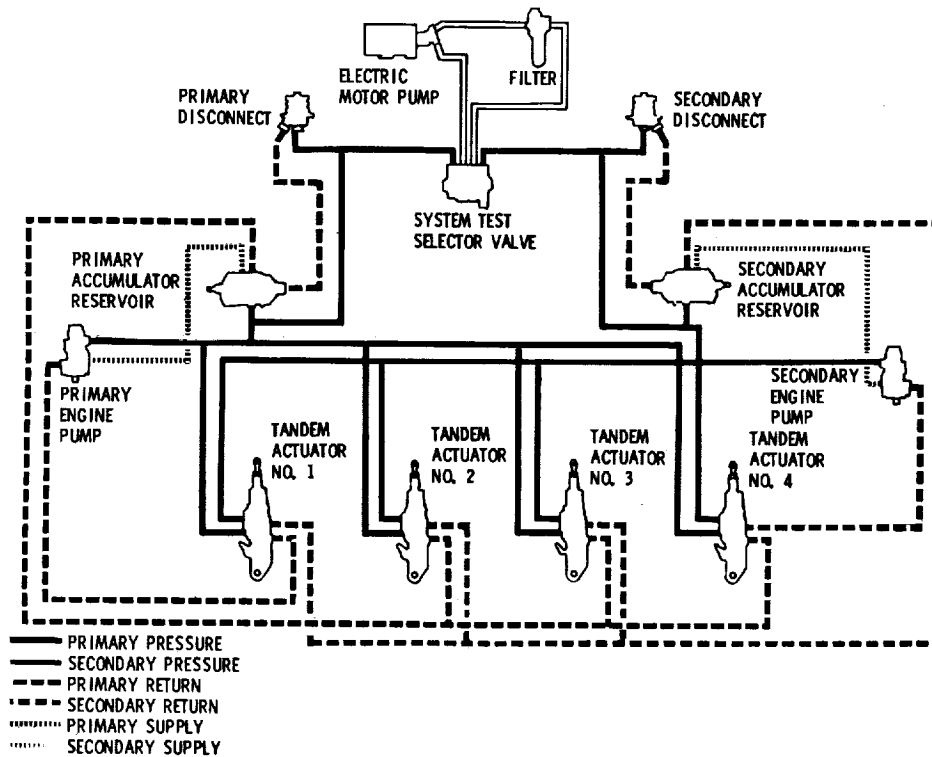

Figure 85.—Gemini launch vehicle stage I hydraulic system. (Martin Photo 8B65778, undated.)

instrumented as a shutdown command. Accordingly, the MOCS killed the launch attempt. Subsequent investigation disclosed that loss of hydraulic pressure had been caused by failure of the primary servo-valve in one of the four tandem actuators which control movement of the stage I thrust chambers. All four stage I tandem actuators were replaced with redesigned actuators.

Mission Report for GT-2, pp. 12-17, 13-1; *Gemini Launch Vehicle Familiarization Manual*, p. 6-1; *Aerospace Final Report*, p. II.E-23; Harris, *Gemini Launch Vehicle Chronology*, p. 47.

1964
December
9

The Mission Control Center at Houston was used passively and in parallel with the Mission Control Center at the Cape in the Gemini-Titan 2 launch attempt, primarily to validate the computer launch programs. In addition, considerable use was made of the telemetry processing program and related television display formats. The Houston control center received, processed, and displayed live and simulated Gemini launch vehicle and spacecraft data. Test results were considered very successful.

Consolidated Activity Report, December 1964, p. 20.

- 12 Gemini Program Office (GPO) reported that it had initiated contractual action to delete the eighth Agena from the Gemini Agena target vehicle program. On March 6, 1965, GPO reported its decision to eliminate the seventh Agena as well.

Weekly Activity Reports: Dec. 6-12, 1964, p. 3; Feb. 28-Mar. 6, 1965, p. 1.

- 15 The Gemini Phase II centrifuge training program was completed. Phase II provided refresher training for Gemini-Titan 3 and 4 flight crews, who made their runs clad in pressure suits. For astronauts not yet officially assigned to a mission the program provided familiarization training under shirt-sleeve conditions. Phase II had begun early in November.

Consolidated Activity Reports: Oct. 18-Nov. 30, pp. 28-29; December 1964, p. 25;
Quarterly Status Reports: No. 11, p. 48; No. 12, p. 43.

- 16 Atlas standard launch vehicle (SLV-3) 5301 was erected on complex 14 at Eastern Test Range. This was not only the Gemini program's first Atlas, but also the first SLV-3 on a new complex. Tests began to validate the pad and its associated aerospace ground equipment (AGE). AGE validation was completed December 30, propellant loading tests in mid-January 1965. Testing ended on February 11 with a flight readiness demonstration.

Weekly Activity Report, Jan. 17-23, 1965, p. 1; Consolidated Activity Report, December 1964, p. 14; Quarterly Status Report No. 12, p. 32; Abstracts of Meetings on Atlas/Agena Coordination, Jan. 20, Mar. 1, 1965.

- 17 Phase III tests to qualify the Gemini parachute recovery system began with a successful drop of static article No. 7. In addition to No. 7, static article No. 4A was also used in the series of 10 tests. All tests were successful, with neither parachute nor sequencing failures. Phase III ended on February 11, 1965, with the 10th drop test. This completed the qualification of the Gemini parachute system.

Weekly Activity Reports: Dec. 13-19, 1964, p. 3; Jan. 10-16, p. 2; Feb. 14-20, 1965, p. 1; Quarterly Status Report No. 12, p. 8.

- 17 Air Force Space Systems Division officially accepted Agena D (AD-82) for the Gemini program. Lockheed then transferred it to the vehicle final assembly area for modification to Gemini Agena target vehicle 5002. Work was scheduled to begin in mid-January 1965.

Weekly Activity Report, Dec. 13-19, 1964, p. 2; *GATV Progress Report*, December 1964, p. 2-7.

- 18 Martin-Baltimore removed the propellant tanks for Gemini launch vehicle

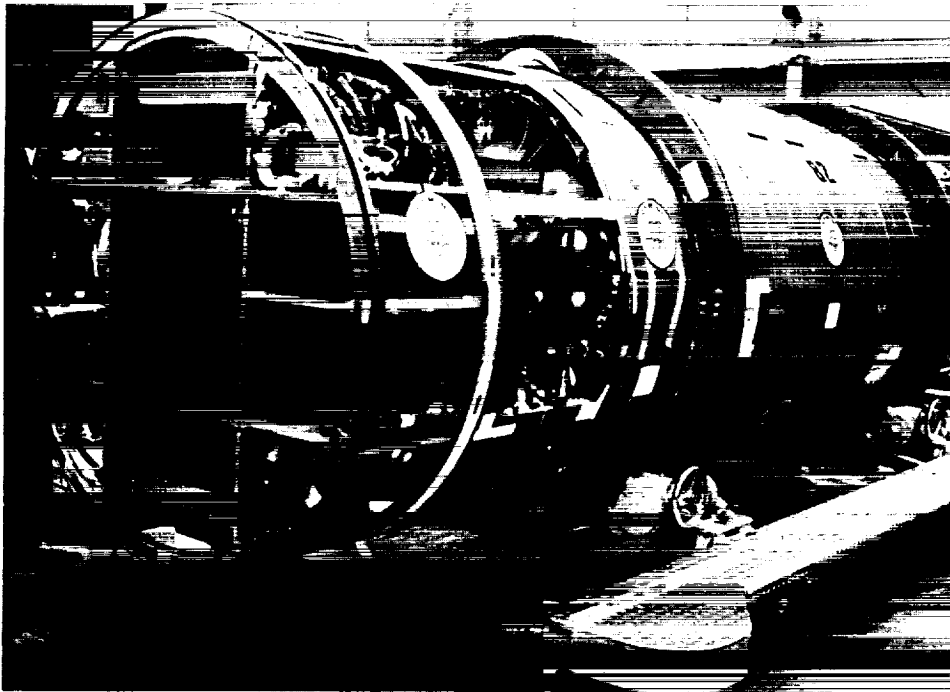

Figure 86.—Agena D 82 undergoing modification to Gemini Agena target vehicle 5002. (Lockheed Photo SA63603-C, Feb. 25, 1965.)

(GLV) 6 from storage. Cleaning the tanks and purging them with nitrogen was completed February 5, 1965. Aerojet-General delivered the flight engines for GLV-6 February 1. Tank splicing was completed February 23, engine installation, February 25. GLV-6 horizontal testing was completed April 3.

Mission Report for GT-VIA, p. 12-7; Aerospace Final Report, p. II.G-5; Gemini-Titan II Air Force Launch Vehicle, p. D-11.

1964
December

Gemini spacecraft No. 3A began thermal qualification tests in the altitude chamber at McDonnell. During test No. 1 (December 19-21), the spacecraft coolant system froze. Over the next three weeks, the coolant system was retested and redesigned. The modified coolant system was subsequently installed in other spacecraft. Test No. 2 was run January 6-13, and the test program ended February 19 with the third test run. The three test runs in total simulated over 220 orbits.

19

Mission Report for GT-IV, p. 12-23; Quarterly Status Report No. 12, p. 45; McDonnell Report No. B427, "Gemini Spacecraft 3A Thermal Test No. 1 Test Results Report, Test Date: 19-21 December 1964," Jan. 12, 1965; McDonnell Report No. B427-1, "... Thermal Test No. 2 . . . , Test Date: 6-13 January 1965," Feb. 15, 1965.

Crew Systems Division received a prototype G4C extravehicular Gemini space suit for testing. This suit contained a thermal/micrometeoroid cover layer, a redundant closure, and the open visor assembly for visual, thermal, and structural protection. Zero-gravity tests in January 1965 showed the suit to be generally

28

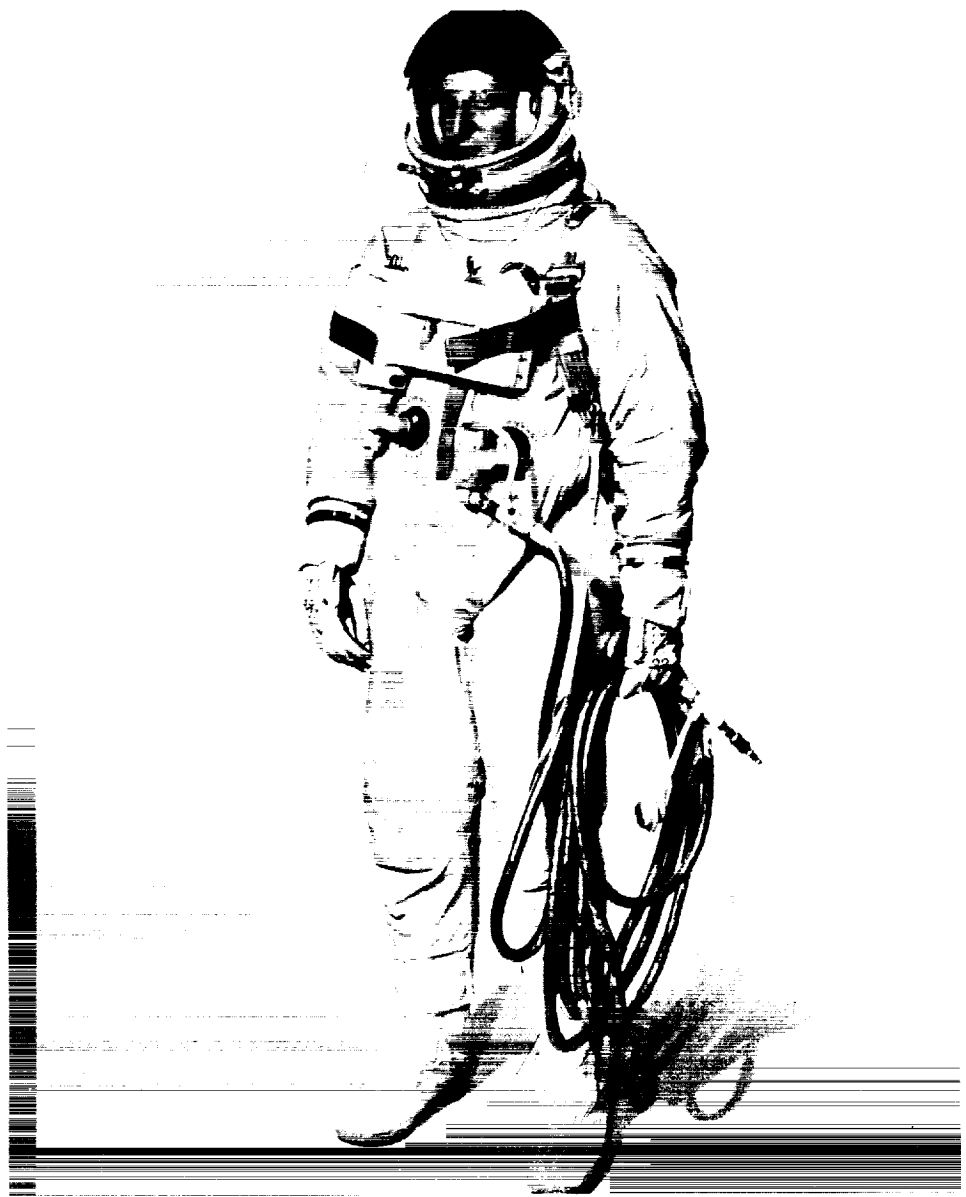

Figure 87.—The Gemini G4C extravehicular suit with chestpack ventilation control module and gold-coated umbilical line. (NASA Photo S-65-27424, May 28, 1965.)

1964
December

satisfactory, but the heavy cover layer made moving around in it awkward. The cover layer was redesigned to remove excess bulk. The new cover layer proved satisfactory when it was tested in February.

Consolidated Activity Report, December 1964, p. 45; Quarterly Status Report No. 12, p. 12.

PART III

Flight Tests



PART III

Flight Tests

McDonnell delivered Gemini spacecraft No. 3 to Cape Kennedy. After its receiving inspection had been completed (January 6), the spacecraft was moved to the Merritt Island Launch Area Radar Range for a communications radiation test. This test, performed only on spacecraft No. 3 because it was scheduled for the first manned mission, exercised spacecraft communi-

1965
January
4

Figure 88.—Gemini spacecraft No. 3 being unloaded at Cape Kennedy. (NASA Photo 104-KSC-65-00003, Jan. 4, 1965.)

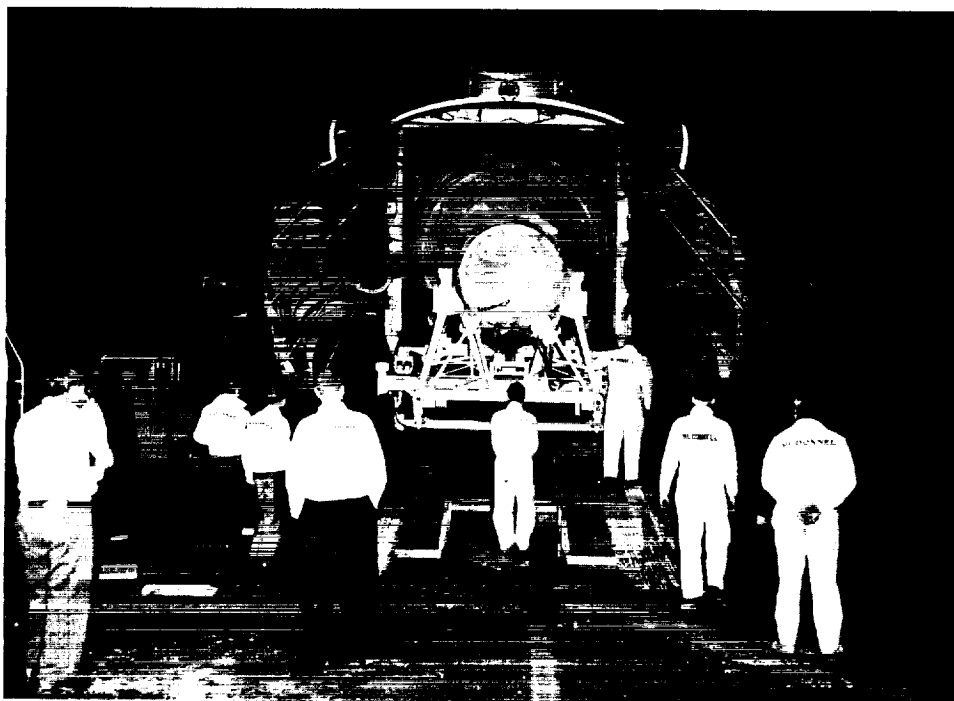

1965
January

cations in a radio-frequency environment closely simulating the actual flight environment. The test was run January 7, and the spacecraft then began preparations for static firing.

Mission Report for GT-3, p. 12-23; *Gemini Midprogram Conference, Including Experiment Results*, NASA SP-121, Feb. 23-25, 1966, p. 214.

- 5 NASA Headquarters provided Flight Operations Division with preliminary data for revising the Gemini-Titan (GT) 3 flight plan to cover the possibility of retrorocket failure. The problem was to ensure the safe reentry of the astronauts even should it become impossible to fire the retrorockets effectively. The Headquarters proposal incorporated three orbit attitude and maneuver system maneuvers to establish a fail-safe orbit from which the spacecraft would re-enter the atmosphere whether the retrorockets fired or not. This proposal, as refined by Mission Planning and Analysis Division, became part of the flight plans for GT-3 and GT-4.

Memo, Asst. Chief, MPAD, to Chief, MPAD, Subj: Complete Revision of the GT-3 Flight Plan, Jan. 7, 1965; Mission Reports: for GT-3, p. 4-1; GT-IV, p. 2-1; letter, John A. Edwards to Kraft, Jan. 5, 1965.

- 6 Manned Spacecraft Center issued the Gemini Program Mission Planning Report, prepared by Gemini Program Office. This report formally defined the objectives of the Gemini program and presented guidelines for individual Gemini missions. These guidelines stated the configuration of space vehicles to be used, specified primary mission objectives, and described the planned missions. The report included guidelines for phasing extravehicular operations into Gemini missions as a primary program objective: a summary of the special equipment required, a statement of the objectives of extravehicular operations, and a description of the kind of operations proposed for each mission beginning with the fifth. Finally, the report described all experiments planned for Gemini missions and named the mission to which each was currently assigned. The report was to be periodically revised, and a detailed mission directive issued for each mission about six months before its scheduled launch.

NASA Program Gemini Working Paper No. 5019, "Gemini Program Mission Planning Report," Jan. 6, 1965.

- 6 Redesigned stage I tandem actuators were received and installed in Gemini launch vehicle (GLV) 2. Although some retesting began shortly after the Gemini-Titan 2 mission was scrubbed on December 9, 1964, most activity in preparing GLV-2 for another launch attempt was curtailed until the new actuators arrived. Subsystems retesting then began. The final combined systems test—the Simulated Flight Test—was completed January 14, with launch scheduled for January 19.

Mission Report for GT-2, pp. 12-18, 12-40.

- 11 The test program to qualify the Gemini escape-system personnel parachute began with two low-altitude dummy drops. The backboard and egress kit failed to separate cleanly; the interference causing the trouble was corrected, and the parachute was successfully tested in two more drops on January 15. Four high-altitude dummy drops followed during the week of January 18. System sequencing was satisfactory, but in two of the four drops the ballute

1965
January

deployed too slowly. The problem was corrected and checked out in two more dummy drops on February 12 and 16. In the meantime, low-altitude live jump tests had begun on January 28. The 12th and final test in this series was completed February 10. Aside from difficulties in test procedures, this series proceeded without incident. High-altitude live jump tests began February 17.

Weekly Activity Reports: Jan. 10-16, p. 2; Jan. 31-Feb. 6, 1965, p. 1; Quarterly Status Report No. 12, p. 10.

Flight tests of the zero-gravity mock-up of the Gemini spacecraft began. The mock-up was installed in a KC-135 aircraft to provide astronauts with the opportunity to practice extravehicular activities under weightless conditions. The Gemini-Titan (GT) 3 flight crew participated in the opening exercises, which were duplicated the next day by the GT-4 flight crew.

Weekly Activity Report, Jan. 10-16, 1965, p. 1; Consolidated Activity Report, January 1965, pp. 12, 16.

A task force in the Office of Manned Space Flight finished a two-month study to determine the requirements for reducing the interval between Gemini flights from three to two months. The findings and recommendations were presented to George E. Mueller, NASA Associate Administrator for Manned Space Flight, on January 19. The task force concluded that an accelerated launch schedule could be fully achieved by Gemini-Titan 6. This required flight-ready vehicles delivered from the factory, with most testing done at the factory rather than at the Cape. Among the major changes caused by implementation of this plan were: spacecraft altitude testing only at McDonnell, activation of the second cell in the vertical test facility at Martin-Baltimore, simplification of subsystems testing at the Cape, and elimination of electronic interference testing and the Flight Configuration Mode Test.

OMSF, "Two Month Launch Interval Study," Jan. 14, 1965; Lt. Col. Alexander C. Kuras and Col. John G. Albert, "Gemini-Titan Technical Summary," Gemini Launch Vehicle Division, 6655th Aerospace Test Wing, Jan. 24, 1967, p. 138; Aerospace *Final Report*, pp. II.F-5, II.F-7; interviews, Leroy E. Day, Washington, Jan. 25, 1967; Scott H. Simpkinson, Houston, Jan. 18, 1967.

Gemini spacecraft No. 3 thrusters were static fired as part of a complete, end-to-end propulsion system verification test program carried out on spacecraft Nos. 2 and 3 to provide an early thorough checkout of servicing procedures and equipment before their required use at the launch complex. The tests also completed development and systems testing of Gemini spacecraft hypergolic systems to enhance confidence in them before they were committed to flight. Deservicing of the propulsion system lasted until January 21.

Mission Report for GT-3, p. 12-23; *Gemini Midprogram Conference*, p. 214.

Engineering and Development Directorate reported that its Crew Systems Division had qualified the Gemini spacecraft bioinstrumentation equipment.

MSC Minutes of Senior Staff Meeting, Jan. 15, 1965, p. 1.

After a long delay because pyrotechnics were not available, simulated off-the-pad ejection (SOPE) qualification testing resumed with SOPE No. 12. Per-

1965
January

formance of the left seat was completely satisfactory, but the right seat rocket catapult fired prematurely because the right hatch actuator malfunctioned. The seat collided with the hatch and failed to leave the test vehicle. All hatch actuators were modified to preclude repetition of this failure. After being tested, the redesigned hatch actuators were used in SOPE No. 13 on February 12. The test was successful, and all systems functioned properly. This portion of the qualification test program came to a successful conclusion with SOPE No. 14 on March 6. The complete ejection system functioned as designed, and all equipment was recovered in excellent condition.

Weekly Activity Report, Jan. 17-23, 1965, p. 2; Quarterly Status Reports: No. 12, p. 9; No. 13 for Period Ending May 31, 1965, p. 8.



Figure 89.—Simulated off-the-pad ejection test No. 13 at U.S. Naval Ordnance Test Station, China Lake, California. (NASA Photo No. 65-H-197, released Feb. 12, 1965.)

- 19 Following a report prepared by Space Technology Laboratories, Mission Planning and Analysis Division recommended the inclusion of "properly located built-in holds in the [Gemini launch vehicle] GLV/Gemini countdown." The study of 325 missile countdowns, 205 missile launches, as well as all Titan scrubs and holds, indicated that GLV launching would be considerably improved and a great many scrubs precluded by the addition of such holds.

Memo, Asst. Chief, MPAD, for Distribution, Subj: Can we launch the GLV on time? (Part II), Jan. 19, 1965.

- 19 During the countdown for Gemini-Titan (GT) 2, the fuel cell hydrogen inlet valve failed to open. Efforts to correct the problem continued until it was determined that freeing the valve would delay the countdown. Work on the fuel cell ceased, and it was not activated for the flight. The fuel cell installed in spacecraft No. 2 was not a current flight design. When fuel cell design was changed in January 1964, several cells of earlier design were available. Although these cells were known to have some defects, flight testing with the reactant supply system was felt to be extremely desirable. Accordingly, it was decided to fly

the entire system on GT-2, but only on a "non-interference with flight" basis. When it became clear that correcting the problem that emerged during the GT-2 countdown would cause delay, fuel cell activation for the flight was called off.

1965
January

Mission Report for GT-2, pp. 6-2, 13-9; note, Day to Seamans, Subj: Gemini Spacecraft #2 Fuel Cell, Jan. 25, 1965.

The second Gemini mission, an unmanned suborbital flight designated *Gemini-Titan 2* (GT-2), was successfully launched from complex 19 at Cape Kennedy at 9:04 a.m., e.s.t. Major objectives of this mission were to demonstrate the adequacy of the spacecraft reentry module's heat protection during a maximum-heating-rate reentry, the structural integrity of the spacecraft from liftoff through reentry, and the satisfactory performance of spacecraft systems. Secondary objectives included obtaining test results on communications, cryogenics, fuel cell and reactant supply system, and further qualification of the launch vehicle. All objectives were achieved, with one exception: no fuel cell test results were obtained because the system malfunctioned before liftoff and was deactivated. GT-2 was a suborbital ballistic flight which reached a maximum altitude of 92.4 nautical miles. Retrorockets fired 6 minutes 54 seconds after launch, and the spacecraft landed in the Atlantic Ocean 11 minutes 22 seconds later—1848 nautical miles southeast of the launch site. Full duration of the mission was 18 minutes 16 seconds. The primary recovery ship, the aircraft carrier *Lake Champlain*, picked up the spacecraft at 10:52 a.m., e.s.t.

19

Mission Report for GT-2, pp. 1-1, 2-1, 2-2, 6-31; MSC Test Evaluation Office, Gemini Program Flight Summary Report, Gemini Missions I through XII, Revision A, January 1967, pp. 6-8; MSC Fact Sheet 291, pp. 5-7; Aerospace *Final Report*, p. II.G-3; Harris, *Gemini Launch Vehicle Chronology*, p. 48.

Gemini Agena target vehicle 5001 underwent a successful hot-firing test at Lockheed's Santa Cruz Test Base. The test simulated a full 20,000-second mission, including multiple firings of both the primary and secondary propulsion systems and transmission of operational data in real time to two PCM (pulse-code-modulated) telemetry ground stations, one at the test site and one in Sunnyvale. Major test anomaly was a series of command programmer time-accumulator jumps, seven of which totaled 77,899 seconds. The vehicle was removed from the test stand on February 1 and returned to Sunnyvale.

20

Weekly Activity Report, Jan. 17-23, 1965, p. 1; Quarterly Status Report No. 12, pp. 32, 34; *GATV Progress Reports*: January, pp. 2-1, 2-2, 2-3; February 1965, p. 1-1.

Installation of pyrotechnics in Gemini spacecraft No. 3 began. Preparation of the spacecraft in the industrial area at Cape Kennedy, which began with the receiving inspection and ended when the spacecraft was transferred to complex 19, was generally limited to non-test activity with certain exceptions. These were the special requirements of the communications test of spacecraft No. 3 and the propulsion verification tests of spacecraft Nos. 2 and 3. Industrial area activity included cleaning up miscellaneous manufacturing shortages, updating spacecraft configuration, installing pyrotechnics and flight seats, building up the rendezvous and recovery section, and preparing the spacecraft for move-

22

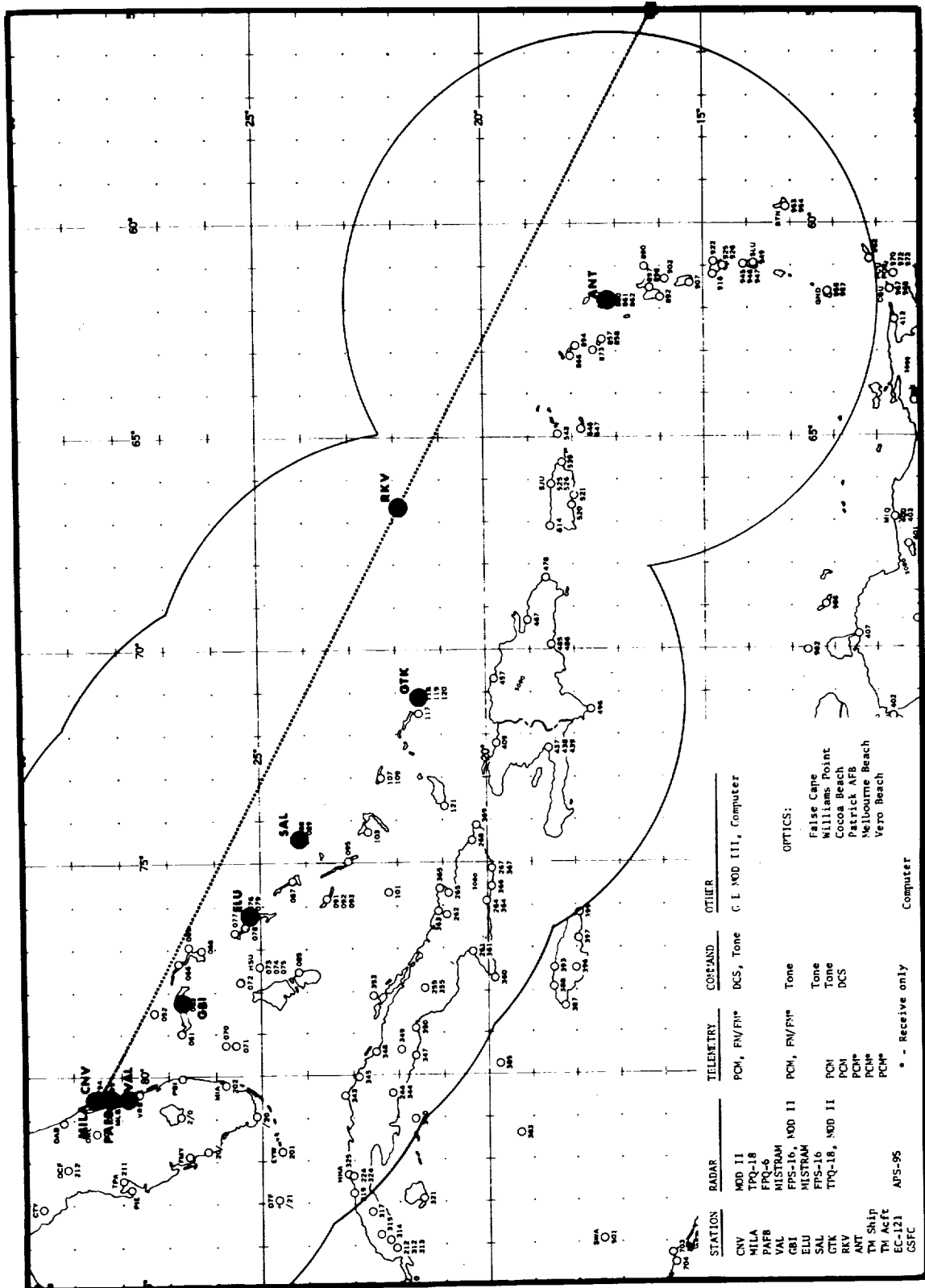

Figure 90.—The tracking network for the second Gemini mission. (Air Force Photo ETR64-287-007/9820-276, Oct. 12, 1964.)

ment to the launch complex. These preparations for spacecraft No. 3 were completed February 4.

1965
January

Mission Report for GT-3, p. 12-23; *Gemini Midprogram Conference*, p. 214.

Gemini launch vehicle 3 was erected at complex 19. Power was applied January 29 and Subsystems Functional Verification Tests (SSFVT) commenced. SSFVT were finished February 12. The Combined Systems Test before spacecraft mating was conducted February 15-16.

25

Mission Report for GT-3, p. 12-26; *Gemini-Titan II Air Force Launch Vehicle*, pp. D-7, D-8.

The NASA-McDonnell incentive contract for the Gemini spacecraft was approved by NASA Headquarters Procurement Office and the Office of Manned Space Flight. The preliminary negotiations between Manned Spacecraft Center (MSC) and McDonnell had been completed on December 22, 1964. The contract was then sent to NASA Headquarters for approval of MSC's position in preliminary negotiations. This position was approved on January 5, 1965, at which time final negotiations began. The negotiations were completed on January 15. The contract was signed by MSC and McDonnell and submitted to NASA Headquarters on January 21 for final approval.

28

Consolidated Activity Report, January 1965, p. 28; Quarterly Status Report No. 12, pp. 47-48.

The High-Altitude Ejection Test (HAET) program resumed with HAET No. 2. This was the first ejection in flight to demonstrate the functional reliability of the Gemini personnel recovery system. The recovery system was ejected from an F-106 at an altitude of 15,000 feet and a speed of mach 0.72. Original plans had called for an ejection at 20,000 feet, but the altitude was lowered because of a change in the Gemini mission ground rules for mode 1 abort. Both seat and dummy were recovered without incident. The program ended on February 12 with HAET No. 3, although the dummy's parachute did not deploy. An aneroid device responsible for initiating chute deployment failed, as did an identical device on February 17 during qualification tests of the personnel parachute. These failures led to redesign of the aneroid, but since the failure could not be attributed to HAET conditions, Gemini Program Office did not consider repeating HAET necessary. All other systems functioned properly in the test, which was conducted from an altitude of 40,000 feet and at a speed of mach 1.7.

28

Weekly Activity Report, Jan. 3-9, 1965, p. 3; Quarterly Status Report No. 12, pp. 9-10.

Qualification testing of the food, water, and waste management systems for the Gemini-Titan 3 mission was completed.

29

Letter, John J. Symons, Whirlpool Corp., Systems Division, to NASA-MSC, Subj: Weekly Progress Report, NASA Houston Contract NAS 9-557, Jan. 29, 1965; Quarterly Status Report No. 12, p. 13.

McDonnell completed major manufacturing activity, module tests, and equipment installation for Gemini spacecraft No. 4. Phase I modular testing had

31

1965
January

begun November 30, 1964. Mating of the spacecraft reentry and adapter assemblies was completed February 23. Systems Assurance Tests began February 24.

Mission Report for GT-IV, p. 12-22; Quarterly Status Reports: No. 11, p. 3; No. 12, p. 45.

February
1

Manned Spacecraft Center (MSC) received on schedule the first qualification configuration extravehicular life-support system (ELSS) chest pack. Tests of this unit and the ELSS umbilical assembly were being conducted at MSC. Meanwhile, AiResearch was preparing for systems qualifications tests. Zero-gravity flight tests of the ELSS had shown that egress and ingress while wearing a chest pack could readily be done by properly trained astronauts.

Quarterly Status Report No. 12, p. 12.

1

Gemini Agena target vehicle (GATV) 5001 was removed from the test stand at Santa Cruz Test Base and returned to Sunnyvale. After a brief stopover in systems test complex C-10, the vehicle was transferred to the anechoic chamber for electromagnetic interference and radio-frequency-interference tests. Test preparations began February 23. At this point, GATV 5001 was 37 calendar days behind schedule, 20 days of which were caused by the time-accumulator anomaly that had developed during hot-firing tests. A temporary fix for the time-accumulator jumps was installed, while Lockheed continued its efforts to diagnose the problem and find a permanent remedy.

Aerospace *Final Report*, pp. III.F-2, III.F-4; *GATV Progress Report*, February 1965, pp. 1-1, 2-1, 2-4, 2-5, 2-6, 2-8.

4

Because of interest expressed by George M. Low, Deputy Director of Manned Spacecraft Center, in spacecraft weight-control vigilance at the previous Gemini Management Panel meeting, Gemini Program Manager Charles W. Mathews reported that weight had increased only 12 pounds in the past month, and a "leveling-off trend" had been discernible over the last two months. Low, however, was still concerned about the dangers of unforeseen growth as the program progressed from flight to flight. Walter F. Burke of McDonnell suggested that redundant systems be eliminated once the primary systems had been proved. Ernst R. Letsch of Aerospace warned that spacecraft weight was growing to over 8000 pounds, which should require some checking of the structural loads. Both Air Force Space Systems Division and the Gemini Program Office were charged by Low to pay close attention to the weight factor.

Minutes of Project Gemini Management Panel Meeting held at SSD, Feb. 4, 1965.

5

Gemini spacecraft No. 3 was moved to complex 19 and hoisted into position atop Gemini launch vehicle 3. Test operations began February 9 with premate systems tests, which lasted until February 13. These were followed by a premate Simulated Flight Test, February 14-16. Data from this testing were compared with data from Spacecraft Systems Tests at McDonnell and predelivery acceptance tests at vendors' plants. The purpose of these tests was to integrate the spacecraft with the launch complex and take a last detailed look at the functioning of all spacecraft systems (especially those in the adapter) before the spacecraft was mechanically mated to the launch vehicle.

Mission Report for GT-3, p. 12-23; *Gemini Midprogram Conference*, p. 215.

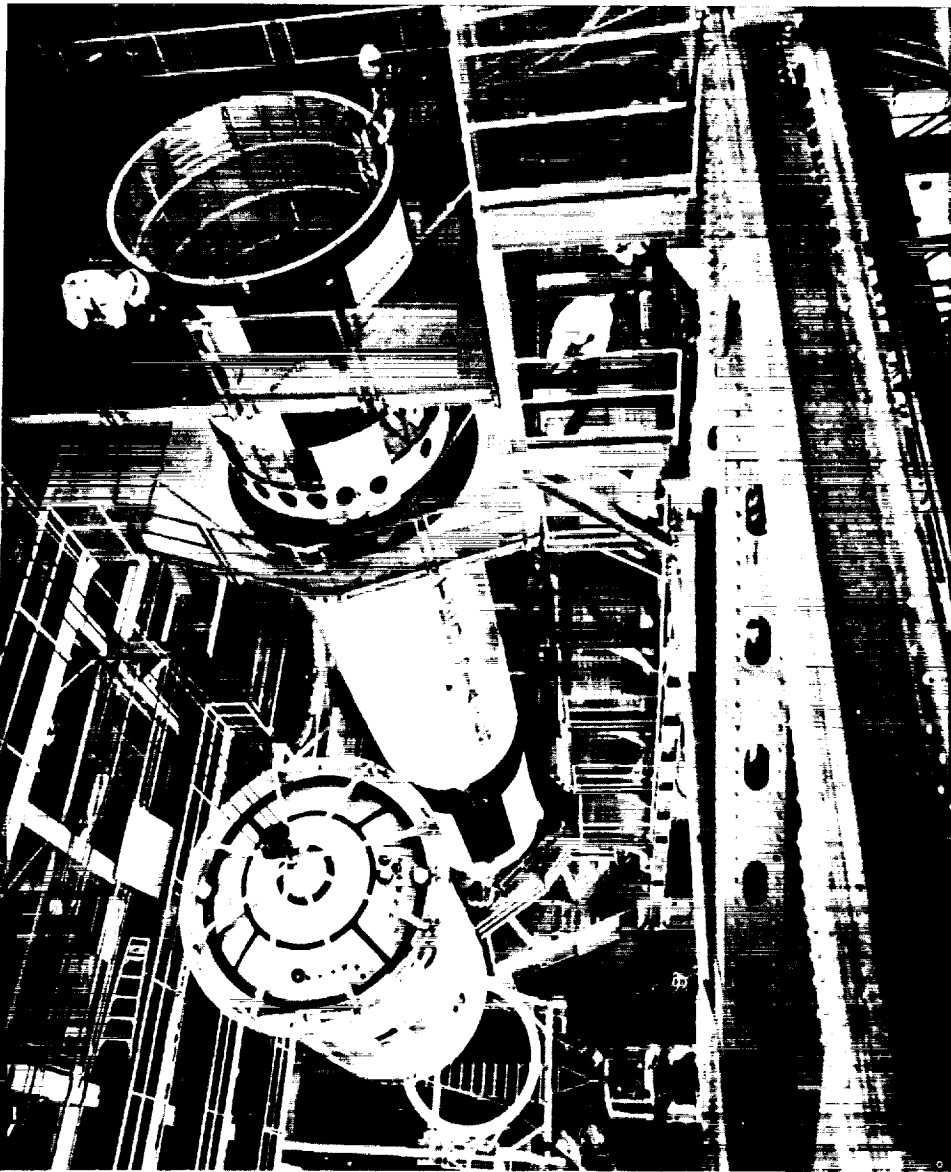

Figure 91.—Second stage of Gemini launch vehicle 5 being hoisted to the top of the vertical test facility at Martin-Baltimore. (NASA Photo S-65-2867, Feb. 8, 1965.)

Modifications to Gemini launch vehicle 5 were completed and stage I was erected in the vertical test facility at Martin-Baltimore. Stage II was erected February 8. Power was applied to the vehicle for the first time on February 15, and Subsystems Functional Verification Tests were completed March 8. Another modification period followed.

Mission Report for GT-V, p. 12-6; *Gemini-Titan II Air Force Launch Vehicle*, pp. D-9, D-10.

Manned Spacecraft Center announced the selection of L. Gordon Cooper, Jr.,

1965
January
5

8

PROJECT GEMINI: A CHRONOLOGY

1965
February

as command pilot and Charles Conrad, Jr., as pilot for the seven-day Gemini-Titan 5 mission. Backup crew would be Neil A. Armstrong and Elliot M. See, Jr.

MSC Space News Roundup, Feb. 17, 1965, p. 1.

- 11 Atlas standard launch vehicle 5301 completed testing on complex 14 with a flight-readiness demonstration. It was then deerected and transferred to Hangar J, where its sustainer engine was to be replaced. Replacement was finished April 19, and the new level sensor and vernier engine was installed on April 21. The vehicle was returned to complex 14 and erected again on June 18.

Weekly Activity Reports: Apr. 18-24, p. 1; June 13-19, 1965, p. 1; *Abstract of Meeting on Atlas/Agena Coordination*, Mar. 1, 1965.

- 12 Director of Flight Operations Christopher C. Kraft, Jr., told the Manned Spacecraft Center senior staff that the Gemini-Titan (GT) 3 mission might be flown between March 22 and 25, although it was officially scheduled for the second quarter of 1965. In addition, the Houston control center was being considered for use in the GT-4 mission.

MSC Minutes of Senior Staff Meeting, Feb. 12, 1965, p. 2.

- 15 Goddard Space Flight Center selected Bendix Field Engineering Corporation, Owings Mills, Maryland, for a contract to operate, maintain, and support the stations of the Manned Space Flight Tracking Network. The cost-plus-award-fee contract was valued at approximately \$36 million over two years.

Material compiled by Alfred Rosenthal.

- 17 Gemini launch vehicle 3 and spacecraft No. 3 were mechanically mated on complex 19. The Electrical Interface Integrated Validation Test was completed February 19, the Joint Guidance and Control Test on February 22. Gemini-Titan 3 combined systems testing included the Joint Combined Systems Test on February 24 and the Flight Configuration Mode Test on March 3.

Mission Report for GT-3, p. 12-26; *Gemini-Titan II Air Force Launch Vehicle*, p. D-8.

- 17 A series of live jumps from high altitude to qualify the Gemini personnel parachute began. The ballute failed to deploy because of a malfunction of the aneroid device responsible for initiating ballute deployment. The identical malfunction had occurred during the high-altitude ejection test on February 12. These two failures prompted a design review of the ballute deployment mechanism. The aneroid was modified, and the qualification test program for the personnel parachute was realigned. In place of the remaining 23 low-altitude live jump tests, 10 high-altitude dummy drops using the complete personnel parachute system (including the ballute), followed by five high-altitude live jumps, would complete the program. The 10 dummy drops were conducted March 2-5 at altitudes from 12,000 to 18,000 feet and at speeds from 130 to 140 knots indicated air speed (KIAS). All sequences functioned normally in all tests but one: in that one, the ballute failed to leave its deployment bag (corrected by eliminating the bag closure pin from the design) and the backboard and egress kit failed to separate (resolved by instituting a special inspection procedure). The five live jumps were conducted March 8-13 at altitudes from

15,000 to 31,000 feet and at a speed of 130 KIAS. Again all tests were successful but one, in which the ballute failed to deploy. After a free fall to 9200 feet, the subject punched the manual override, actuating the personnel parachute. This series completed qualification of the personnel parachute and also of the overall Gemini escape system.

1965
February

Weekly Activity Reports: Feb. 14-20, pp. 1-2; Feb. 21-27, 1965, p. 1; Quarterly Status Reports: No. 12, pp. 10-11; No. 13, pp. 8-9.

During the week, the Gemini-Titan 3 prime crew participated in egress training from static article No. 5 in the Gulf of Mexico. After half an hour of postlanding cockpit checks with the hatches closed, Astronauts Virgil I. Grissom and John W. Young practiced the emergency egress procedures developed by the flight crew training staff for Gemini. Both pilots then egressed through the left (command pilot's) hatch, after first heaving their survival kits into the water. Each astronaut then practiced boarding a Gemini one-man life raft. Swimmers were standing by in a larger raft.

21

MSC Space News Roundup, Mar. 3, 1965, p. 8.

Martin-Denver delivered propellant tanks for Gemini launch vehicle (GLV) 7 to Martin-Baltimore. Tank fabrication had begun in May 1964. Martin-Baltimore recleaned and purged the tanks with nitrogen by April 20, 1965. In the meantime, flight engines for GLV-7 arrived from Aerojet-General on April 17. Tank splicing was completed May 6 and engine installation May 20. All horizontal testing was completed June 14. A modification period followed.

25

Gemini Program Mission Report, Gemini VII, January 1966, p. 12-6; Aerospace Final Report, p. II.G-5; *Gemini-Titan II Air Force Launch Vehicle*, pp. D-12, D-13.

A full-scale rehearsal of the flight crew countdown for Gemini-Titan 3 was conducted at the launch site. Procedures were carried out for moving the flight crew from their quarters in the Manned Spacecraft Center operations building at Merritt Island to the pilot's ready room at complex 16 at Cape Kennedy. Complete flight crew suiting operation in the ready room, the transfer to complex 19, and crew ingress into the spacecraft were practiced. Practice countdown proceeded smoothly and indicated that equipment and procedures were flight ready.

26

Quarterly Status Report No. 12, p. 13.

Lockheed initiated a "Ten-point Plan for C&C Equipment." The Agena command and communication (C and C) system comprised the electronic systems for tracking the vehicle, for monitoring the performance of its various subsystems, and for verifying operating commands for orbital operations. Because of the unique requirements of the Gemini mission, in particular rendezvous and docking, Lockheed had had to design and develop a new C and C system for the Gemini target vehicle. Numerous failures and problems calling for rework during the initial manufacturing stages of the C and C system suggested the existence of mechanical and electronic design deficiencies. Aerospace, which had assumed technical surveillance functions for the Gemini Agena in the fall of 1964, was instrumental in bringing these problems to the attention of Air Force and Lockheed top management. Among the results of the 10-point plan were

During
the
month

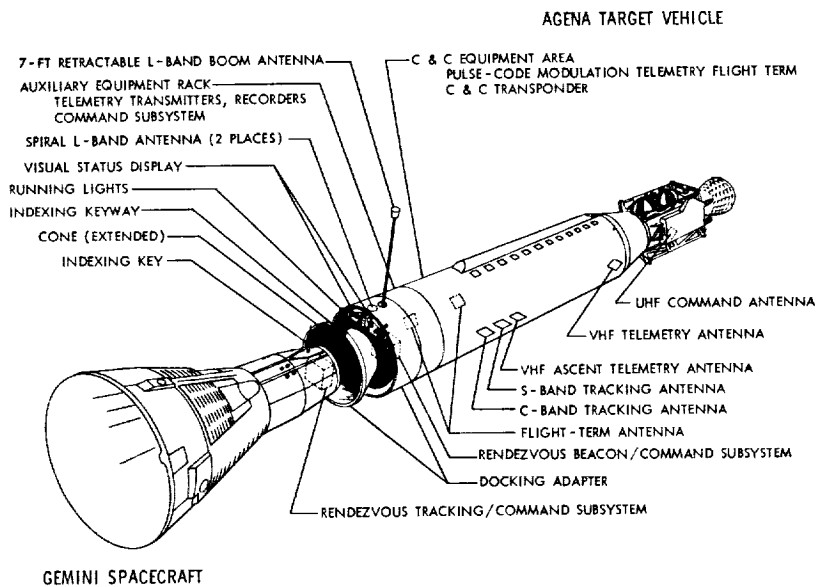

Figure 92.—Location of command and communications system equipment on the Agena target vehicle. (Lockheed Photo NP-2-23, June 1,

1965
February

several redesigned programmer circuits and packaging changes, closer monitoring of vendor work, expedited failure analysis, and improved quality control.

Aerospace Final Report, p. III.E-1; GATV Progress Reports: February, p. 4-1; March, p. 4-1; April 1965, p. 2-13; letter, Hohmann to Grimwood.

March
1-2

Office of Manned Space Flight held the Gemini manned space flight design certification review in Washington. Chief executives of all major Gemini contractors certified the readiness of their products for manned space flight. Gemini-Titan 3 was ready for launch as soon as the planned test and checkout procedures at Cape Kennedy were completed.

Weekly Activity Report, Feb. 28-Mar. 6, 1965, p. 2; interview, MacDougall, Houston, Sept. 20, 1967.

2

McDonnell completed Systems Assurance Tests of Gemini spacecraft No. 4. The Simulated Flight Test was conducted February 27-March 8. Preparations for altitude chamber testing lasted until March 19.

Mission Report for GT-IV, p. 12-22.

6

AiResearch completed dynamic qualification tests of the environmental control system.

Weekly Activity Report, Mar. 7-13, 1965, p. 1.

8

The Wet Mock Simulated Launch of Gemini-Titan 3 was successfully conducted. Countdown exercises were concluded on March 18 with the Simulated Flight Test.

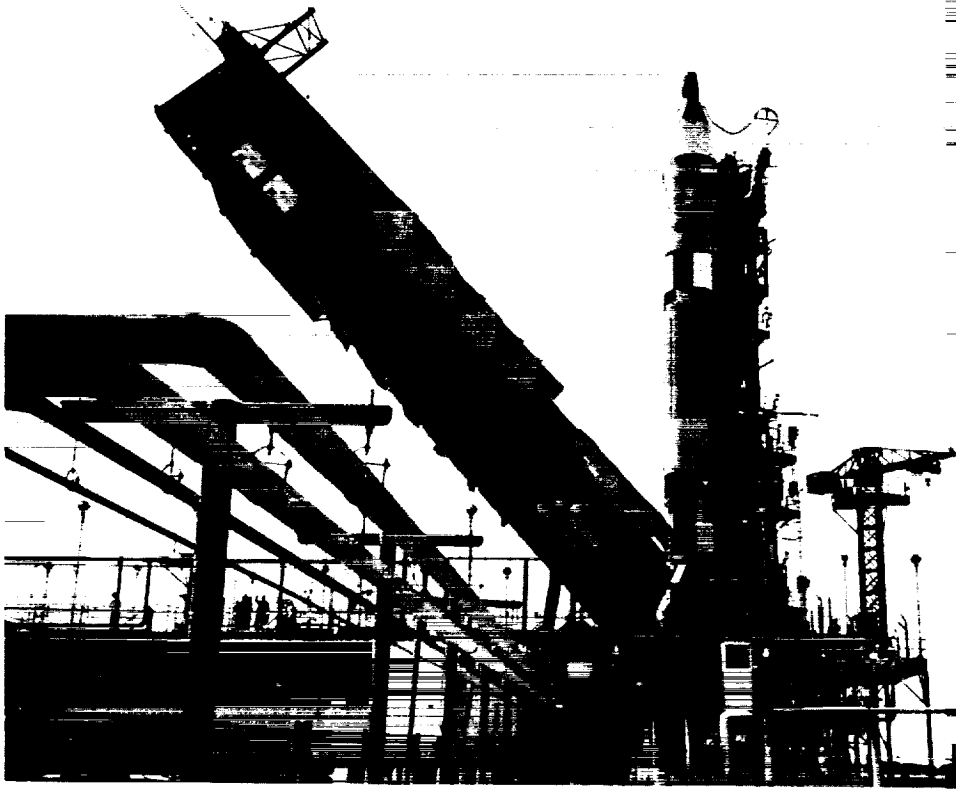

Figure 93.—Gemini-Titan 3 on pad 19 during final countdown exercises. (NASA Photo No. 65-H-406, released Mar. 19, 1965.)

Mission Report for GT-3, p. 12-26; *Gemini-Titan II Air Force Launch Vehicle*, p. D-8.

Gemini Agena target vehicle 5001 completed electromagnetic compatibility tests in the anechoic chamber at Sunnyvale. It remained in the chamber, however, until March 17 while Lockheed verified the corrective action that had been taken to eliminate programmer time-accumulator jumps and telemetry synchronization problems. The vehicle was then transferred to systems test complex C-10 for final Vehicle Systems Tests on March 18.

1965
March
9

GATV Progress Report, March 1965, pp. 2-3 through 2-6.

The official roll-out inspection of Gemini launch vehicle (GLV) 4 was conducted at Martin-Baltimore. Air Force Space Systems Division formally accepted delivery of the vehicle March 21, and preparations to ship it to Cape Kennedy began at once. GLV-4 stage I arrived at the Cape March 22, followed the next day by stage II.

10

Mission Report for GT-IV, pp. 12-26, 12-27; *Aerospace Final Report*, p. II.G-5; *Gemini-Titan II Air Force Launch Vehicle*, p. D-9; Harris, *Gemini Launch Vehicle Chronology*, p. 44.

At a meeting of the Gemini Trajectory and Orbits Panel, Air Force Space Systems Division repeated its position that on Gemini-Titan 6 the nominal

10

1965
March

plan should *not* call for use in orbit of the Agena primary propulsion system, since it would not be qualified in actual flight before this mission. At the same meeting, Gemini Program Office announced that a decision had been made to provide only enough electrical power for 22 orbits on spacecraft No. 6. This spacecraft constraint, combined with reentry and recovery considerations, would restrict the nominal mission plan to approximately 15 orbits.

Abstract of Meeting on Trajectories and Orbits, Mar. 28, 1965.

- 14 McDonnell finished manufacturing, module tests, and equipment installation for Gemini spacecraft No. 5. Spacecraft assembly was completed April 1 with the mating of the reentry and adapter assemblies. Systems Assurance Tests began April 30.

Mission Report for GT-V, p. 12-2.

- 18 Gemini Agena target vehicle (GATV) 5001 was transferred from the anechoic chamber to systems test complex C-10. Six days were scheduled for vehicle modifications before beginning final systems tests. Unexpected difficulties in incorporating filters in the command controller, which required considerable redesign, and alignment problems with the forward auxiliary rack, which required extensive machining, imposed a lengthy delay. These problems added 29 days of slippage to the GATV 5001 schedule, leaving the vehicle 66 calendar days behind schedule by the end of March. Machining of the forward auxiliary rack was completed April 5, and vehicle systems testing finally began April 9.

Weekly Activity Report, Apr. 4-10, 1965, p. 1; Abstract of Meeting on Atlas/Agena Coordination, May 5, 1965; *GATV Progress Reports*: March, pp. 2-3 through 2-6; April 1965, p. 2-1.

Figure 94.—Gemini spacecraft No. 4 entering the 14-foot altitude chamber at McDonnell before simulated high-altitude tests. (NASA Photo S-65-3420, Mar. 16, 1965.)

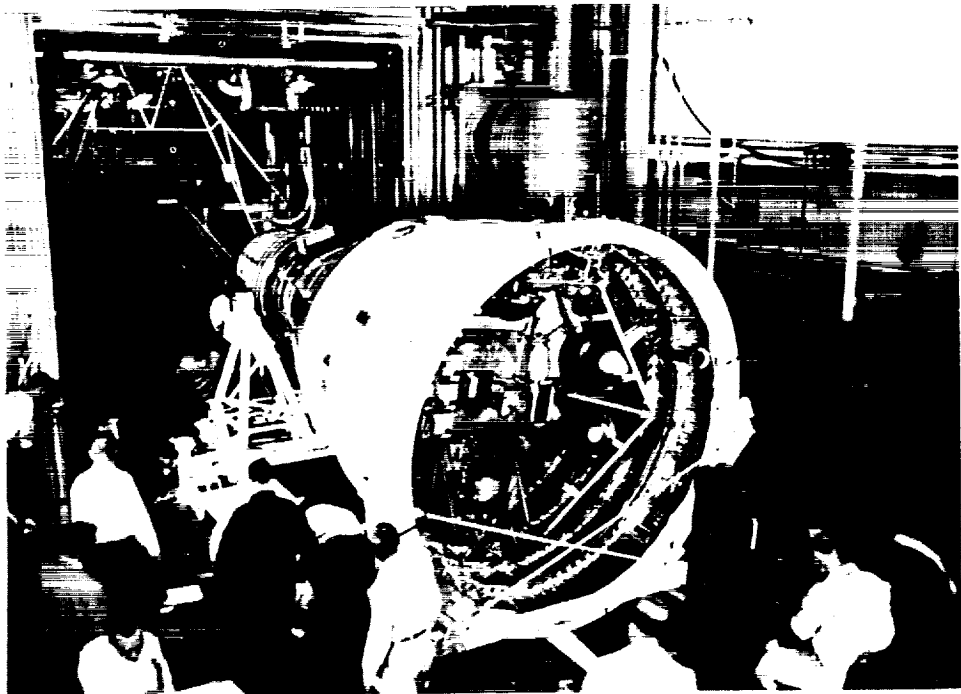

1965
March
20

Altitude Chamber Tests of Gemini spacecraft No. 4, involving five simulated flights, began at McDonnell. The first run was unmanned. In the second run, the prime crew flew a simulated mission, but the chamber was not evacuated. The third run repeated the second, with the backup crew replacing the prime crew. The fourth run put the prime crew through a flight at simulated altitude,

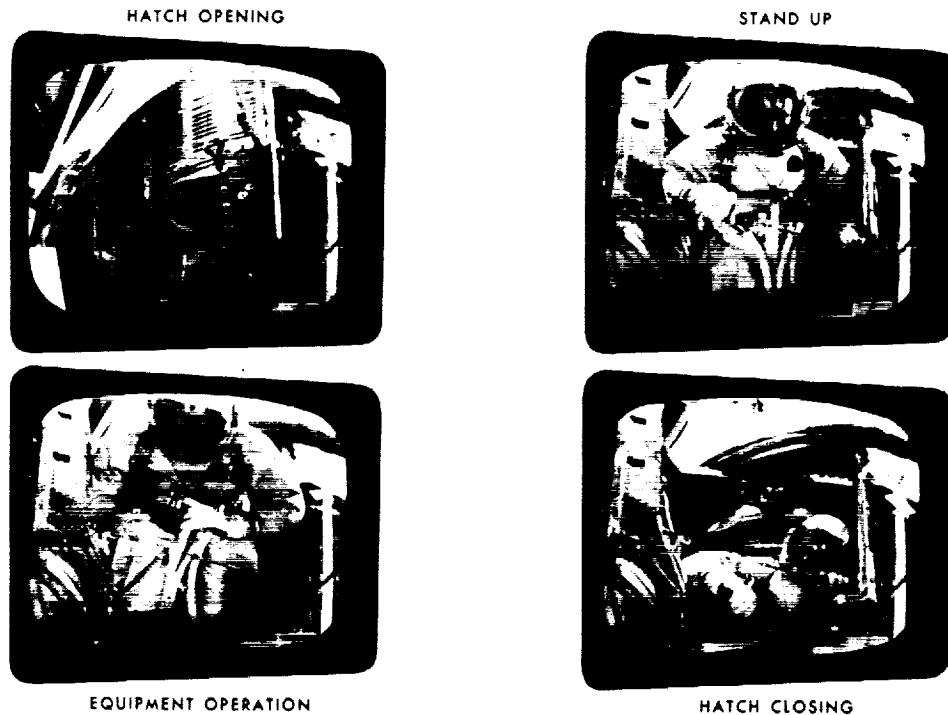

Figure 95.—Astronaut Edward H. White II practices standup extravehicular activity at a simulated altitude of 150,000 feet in the McDonnell altitude chamber. (NASA Photo S-65, 4896, Mar. 24, 1965.)

and the fifth did the same for the backup crew. Altitude chamber testing ended March 25, and the spacecraft was prepared for shipment to Cape Kennedy.

Mission Report for GT-IV, p. 12-22; Weekly Activity Report, Mar. 21-27, 1965, p. 1; *Gemini Midprogram Conference*, p. 86.

Gemini-Titan 3 (GT-3), the first manned mission of the Gemini program, was launched from complex 19 at 9:24 a.m., e.s.t. The crew were command pilot Astronaut Virgil I. Grissom and pilot Astronaut John W. Young. Major objectives of the three-orbit mission were demonstrating manned orbital flight in the Gemini spacecraft, evaluating spacecraft and launch vehicle systems for future long-duration flights, demonstrating orbital maneuvers with the spacecraft orbit attitude and maneuver system (OAMS) and use of the OAMS in backing up retrorockets, and demonstrating controlled reentry flight path and landing point. Landing point accuracy was unexpectedly poor. The spacecraft landed at 2:16 p.m. about 60 nautical miles from its nominal landing point. The flight crew left the spacecraft shortly after 3:00 and was transported by heli-

23

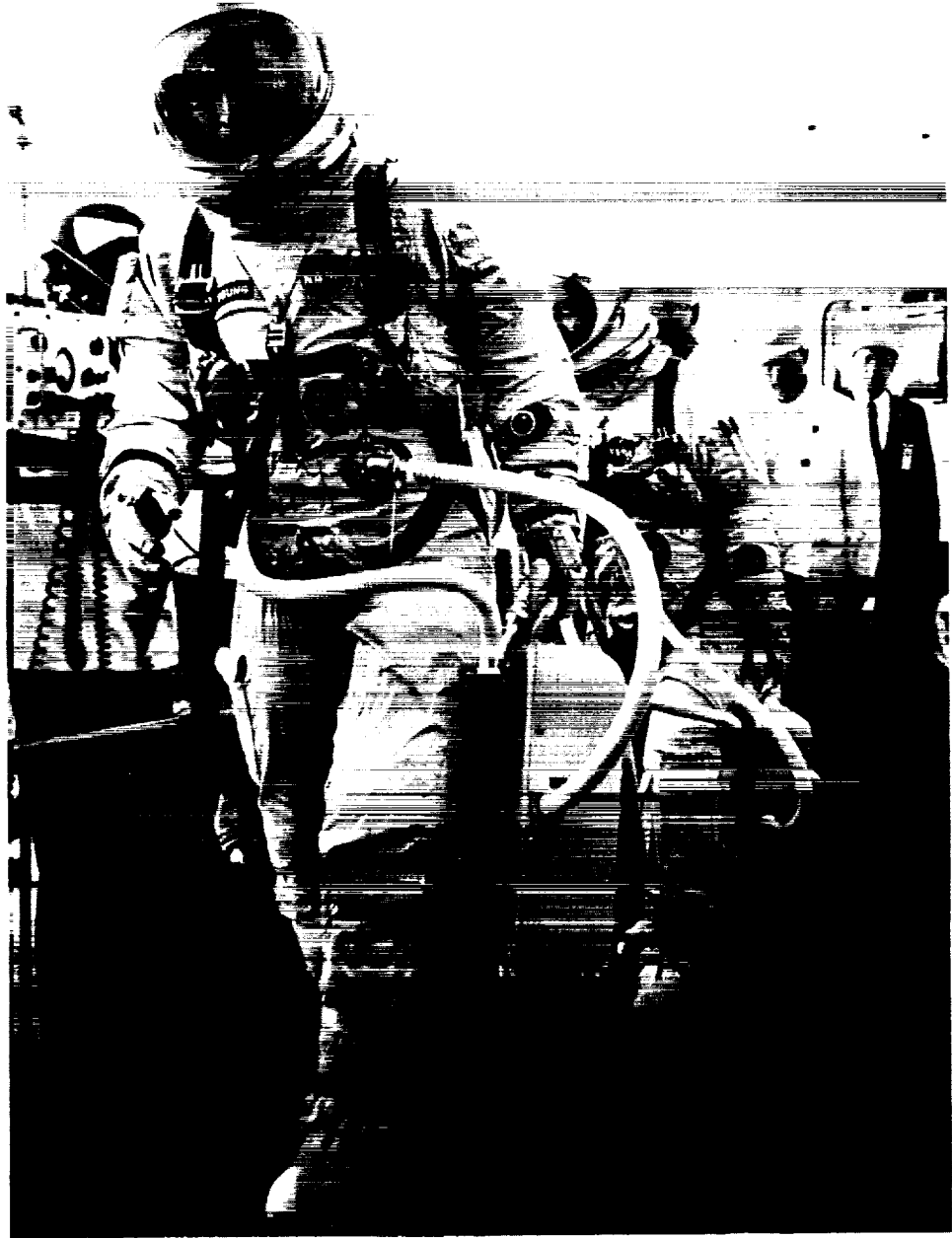

Figure 96.—Astronauts Young and Grissom walk up the ramp leading to the elevator that will carry them to the spacecraft for the first manned Gemini mission. They wear Gemini G3C intravehicular suits. (NASA Photo No. 65-H-438, released Mar. 23, 1965.)

1965
March

copter to the prime recovery ship, the aircraft carrier *Intrepid*. Spacecraft recovery was completed at 5:03. During the flight, Grissom successfully performed three orbital maneuvers. Among the secondary objectives of the mission

were the execution of three experiments. Two were successfully conducted, but the third—the effects of zero gravity on the growth of sea urchin eggs—was not, because of a mechanical failure of the experimental apparatus.

Mission Report for GT-3, pp. 1-1, 2-1, 2-2, 6-21, 7-3, 8-1.

1965
March

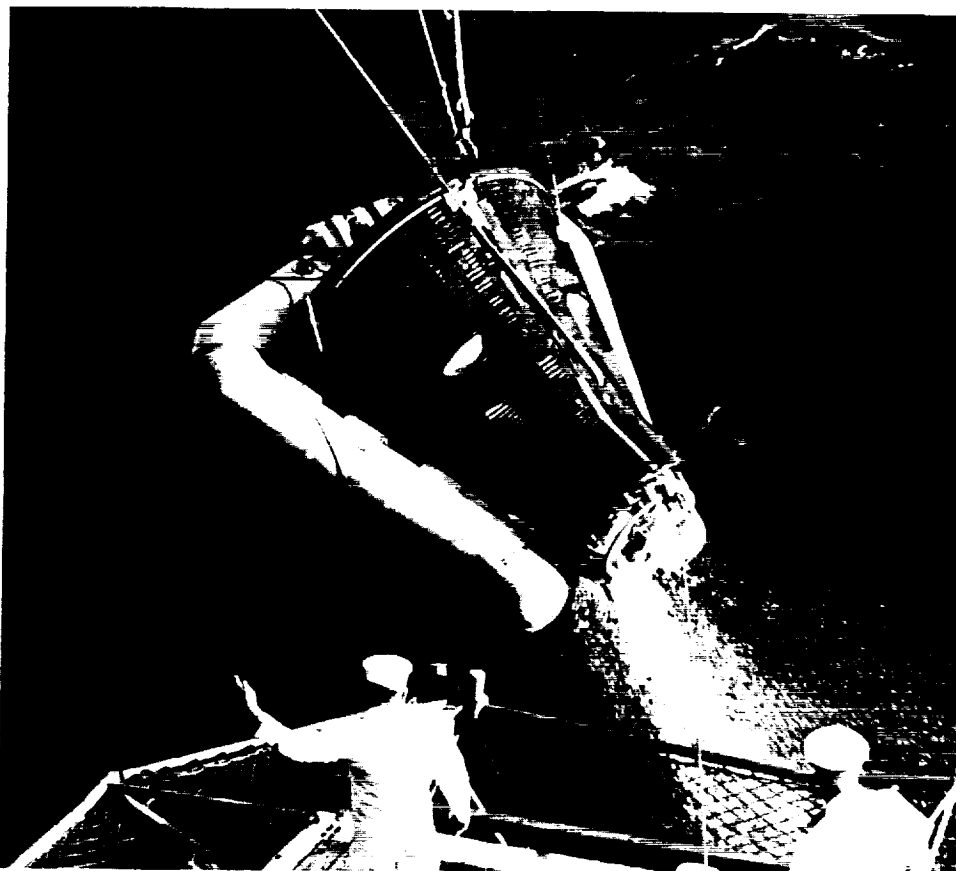

Figure 97.—Gemini spacecraft No. 3, wearing a flotation collar, being hoisted aboard the U.S.S. Intrepid after landing. (NASA Photo No. 65-H-462, released Mar. 23, 1965.)

Representatives of Air Force Space Systems Division (SSD), Aerospace, Lockheed, and Gemini Program Office met at Sunnyvale for the monthly Gemini Agena Target Vehicle (GATV) Management-Technical Review. SSD recommended that the current configuration of the oxidizer gas generator solenoid valve be removed from GATV 5001 because of the recent failure of the valve during 38-day oxidizer star-system storage tests at Bell Aerosystems. Following the meeting, Lockheed formed a team to evaluate the design of the valve. A redesigned valve began qualification tests in July.

GATV Progress Reports: March, pp. 2-13, 7-3; July 1965, p. 2-20.

The orbit attitude and maneuver system (OAMS) 25-pound thrusters installed in spacecraft No. 4 were replaced with new long-life engines. Installation of the new engines had been planned for spacecraft No. 5, but they were ready

23-24

27

1965
March

earlier than had been anticipated. Early in February, Rocketdyne had completed the significant portion of the qualification test program on the OAMS and reentry control systems as configured for spacecraft Nos. 3, 4, and 5; however, some further testing extended final qualification until mid-April. OAMS component qualification for the spacecraft 6 (and up) configuration was achieved early in June. The total ground qualification of all Gemini spacecraft liquid propellant rocket systems was completed in August with the system qualification of the OAMS in the spacecraft 6 configuration.

Weekly Activity Report, Mar. 21-27, 1965, p. 1; "Gemini Propulsion by Rocketdyne," p. 3.

- 29 The possibility of doing more than the previously planned stand-up form of extravehicular activity (EVA) was introduced at an informal meeting in the office of Director Robert R. Gilruth at Manned Spacecraft Center (MSC). Present at the meeting, in addition to Gilruth and Deputy Director George M. Low, were Richard S. Johnston of Crew Systems Division (CSD) and Warren J. North of Flight Crew Operations Division. Johnston presented a mock-up of an EVA chestpack, as well as a prototype hand-held maneuvering unit. North expressed his division's confidence that an umbilical EVA could be successfully achieved on the Gemini-Titan 4 mission. Receiving a go-ahead from Gilruth, CSD briefed George E. Mueller, Associate Administrator for Manned Space Flight, on April 3 in Washington. He, in turn, briefed the Headquarters Directorates. The relevant MSC divisions were given tentative approval to continue the preparation and training required for the operation. Associate Administrator of NASA, Robert C. Seamans, Jr., visited MSC for further briefing on May 14. The enthusiasm he carried back to Washington regarding flight-readiness soon prompted final Headquarters approval.

Interview, Low, Houston, Feb. 7, 1967.

- 29 Gemini launch vehicle 4 was erected at complex 19. After the vehicle had been inspected, umbilicals were connected March 31 and power applied April 2. Subsystems Functional Verification Tests began immediately and were completed April 15. The Prespacecraft Mate Combined Systems Test was conducted the next day (April 16).

Mission Report for GT-IV, p. 12-27; *Gemini-Titan II Air Force Launch Vehicle*, p. D-9.

April
4

McDonnell delivered Gemini spacecraft No. 4 to Cape Kennedy. Receiving inspection was completed April 6. Other industrial area activities, including pyrotechnic buildup, temporary installation of seats, and final preparation for pad testing were completed April 14. The spacecraft was then moved to complex 19.

Mission Report for GT-IV, p. 12-24.

- 5 Manned Spacecraft Center announced that Walter M. Schirra, Jr., and Thomas P. Stafford had been selected as command pilot and pilot for Gemini-Titan 6, the first Gemini rendezvous and docking mission. Virgil I. Grissom and John W. Young would be the backup crew.

Astronautics and Aeronautics, 1965: A Chronology on Science, Technology, and Policy, NASA SP-4006, p. 170.

Manned Spacecraft Center delivered the "Gemini Atlas Agena Target Vehicle Systems Management and Responsibilities Agreement" to Air Force Space Systems Division (SSD) with signatures of Director Robert R. Gilruth and Gemini Program Manager Charles W. Mathews (dated April 9). Major General Ben I. Funk, SSD Commander, and Colonel John B. Hudson, SSD Deputy for Launch Vehicles, had signed for SSD on March 31 and 29 respectively. The agreement, dated March 1965, followed months of negotiation and coordination on management relationships and fundamental responsibilities for the Gemini Agena target vehicle program. It clarified and supplemented the "Operational and Management Plan for the Gemini Program" (December 29, 1961) with respect to the target vehicle program.

1965
April
13

Weekly Activity Report, Apr. 25–May 1, 1965, p. 1; Abstract of Meeting of Atlas/Agena Coordination, May 5, 1965; "Gemini Atlas Agena Target Vehicle System Management and Responsibilities Agreement between the NASA-MSC and USAF, AFSC, SSD," March 1965; Aerospace *Final Report*, p. III.A-1.

Gemini spacecraft No. 4 was hoisted into position atop the launch vehicle. Cabling for test was completed April 19, and pre-mate systems tests began. For the first time, Mission Control Center, Houston, supported Kennedy Space Center pad operations. Systems testing ended April 21. The Prespacecraft Mate Simulated Flight Test was conducted April 22–23.

14

Mission Report for GT-IV, p. 12–24; NASA-MSC Quarterly Activity Report for Office of the Associate Administrator, Manned Space Flight, for period ending April 30, 1965, p. 8 (hereafter cited as Quarterly Activity Report—formerly Consolidated Activity Report).

Gemini launch vehicle (GLV) 6 was erected in the vertical test facility at Martin-Baltimore. GLV-6 was the first vehicle in the new west test cell, which Martin had finished installing and checking out in January. At this time, GLV-5 was still undergoing vertical tests in the other test cell. Because both cells used the same power sources and aerospace ground equipment connections, simultaneous testing was impossible; however, one vehicle could be inspected and prepared for test while the other was being tested. Power was applied to GLV-6 for the first time on May 13. Subsystems Functional Verification Tests continued until June 22.

14–15

Mission Report for GT-VIA, p. 12–7; Aerospace *Final Report*, pp. II.F-2, II.G-5; *Gemini-Titan II Air Force Launch Vehicle*, p. D-11; Harris, *Gemini Launch Vehicle Chronology*, p. 47.

Martin-Denver delivered the propellant tanks for Gemini launch vehicle 8 to Martin-Baltimore. Tank fabrication had begun September 25, 1964. Aerojet-General delivered the stage I engine on June 16 and the stage II on August 20. In the meantime, tank splicing was completed August 3. Engine installation was completed September 23, and all horizontal testing ended September 27.

15

Gemini Program Mission Report, Gemini VIII, Apr. 29, 1966, p. 12–6; Aerospace *Final Report*, p. II.G-5; *Gemini-Titan II Air Force Launch Vehicle*, p. D-14.

McDonnell completed Systems Assurance Tests of Gemini spacecraft No. 5. The environmental control system was validated April 24, and fuel cell reinstallation was completed April 26. The fuel cell had failed during reentry/adapter mating operations on April 16.

20

Mission Report for GT-V, pp. 12–2, 12–3.

PROJECT GEMINI: A CHRONOLOGY

1965
April
21

The Combined Systems Acceptance Test (CSAT) of Gemini launch vehicle (GLV) 5 was conducted in the vertical test facility at Martin-Baltimore. Four earlier CSAT attempts (April 15-20) were marred by numerous minor anomalies. The vehicle acceptance team inspection began April 26 and concluded April 30, with GLV-5 found acceptable. The vehicle was removed from the test cell May 7-8, formally accepted by the Air Force May 15, and shipped to Cape Kennedy. Stage I arrived at the Cape on May 17 and stage II on May 19.

Mission Report for GT-V, pp. 12-6, 12-7; Aerospace *Final Report*, p. II.G-5; *Gemini-Titan II Air Force Launch Vehicle*, p. D-10; Harris, *Gemini Launch Vehicle Chronology*, p. 50.

22

The Abort Panel met to review abort criteria for Gemini-Titan (GT) 4 and decided that GT-3 rules would suffice. Alternate procedures for delayed mode 2 abort would be investigated when the Manned Spacecraft Center abort trainer became available to the GT-5 mission.

Weekly Activity Report, Apr. 25-May 1, 1965, p. 1.

23

Gemini launch vehicle (GLV) 4 and spacecraft No. 4 were mechanically mated at complex 19. The Electrical Interface Integrated Validation and Joint Guidance and Control Test were completed April 26-29. These had been separate tests for earlier vehicles, but from Gemini-Titan 4 on, the tests were combined and performed as one. The spacecraft/GLV Joint Combined Systems Test followed on April 30. The Flight Configuration Mode Test finished systems testing May 7.

Mission Report for GT-IV, p. 12-27; *Gemini Midprogram Conference*, pp. 222-223.

26

The Simulated Flight Test of Gemini spacecraft No. 5 began at McDonnell. During the test (April 28) the environmental control system (ECS) was inadvertently overpressurized. The test was halted while the ECS suit loop was investigated. Reinstallation was completed May 8, and the ECS and guidance and control systems were retested May 9-11. Simulated flight testing was resumed May 11 and completed May 19. Preparations for altitude chamber testing lasted until May 25.

Mission Report for GT-V, pp. 12-2, 12-3; Weekly Activity Reports: Apr. 25-May 1, p. 2; May 2-8, 1965, pp. 1-2.

May
4

McDonnell completed manufacturing, module tests, and equipment installation for Gemini spacecraft No. 6. Mating the reentry and adapter assemblies completed final assembly of the spacecraft on May 12. Cabling and test preparation lasted until June 4, when Systems Assurance Tests began.

Mission Report for GT-VIA, p. 12-2.

5

Discussing the landing point error of *Gemini 3*, Charles W. Mathews told the Gemini Management Panel that the spacecraft had developed a smaller angle of attack than planned and that the lift capability had been less than wind tunnel tests had indicated.

Minutes of Project Gemini Management Panel Meeting held at MSC, May 5, 1965.

Gemini Agena target vehicle (GATV) 5001 completed vehicle systems testing with a final simulated flight. The vehicle was disconnected from the test complex on May 14, and data analysis was completed May 19. Meanwhile, the First Article Configuration Inspection on GATV 5001 began on May 10.

1965
May
6

Weekly Activity Reports: May 2-8, p. 1; May 9-15, 1965, p. 1; *GATV Progress Report*, May 1965, pp. 2-1, 2-2.

A team of representatives from NASA, Air Force Space Systems Division, Aerospace, and Lockheed began the First Article Configuration Inspection (FACI) of Gemini Agena target vehicle (GATV) 5001 at Sunnyvale. A FACI acceptance team reviewed and evaluated all drawings, specifications, test procedures and reports, component and assembly log books, and qualification and certification documentation relating to GATV 5001. The resulting record of discrepancies then served as a basis for corrective action. FACI, a standard Air Force procedure established in June 1962, was essentially an audit performed by the Air Force with contractor support to reconcile engineering design, as originally released and subsequently modified, with the actual hardware produced. Its purpose was to establish the production configuration base line under which remaining contract end items (in this case, GATV 5002 and up) of the same configuration were to be manufactured and delivered to the Air Force. FACI on GATV 5001 was completed May 26.

10

Weekly Activity Report, May 9-15, 1965, p. 1; Quarterly Status Report No. 13, p. 20; *GATV Progress Report*, May 1965, p. 2-12.

Figure 98.—Weight and balance test of Astronaut McDivitt during the Wet Mock Stimulated Launch of Gemini-Titan 4. (NASA Photo No. 65-H-797, released May 21, 1965.)

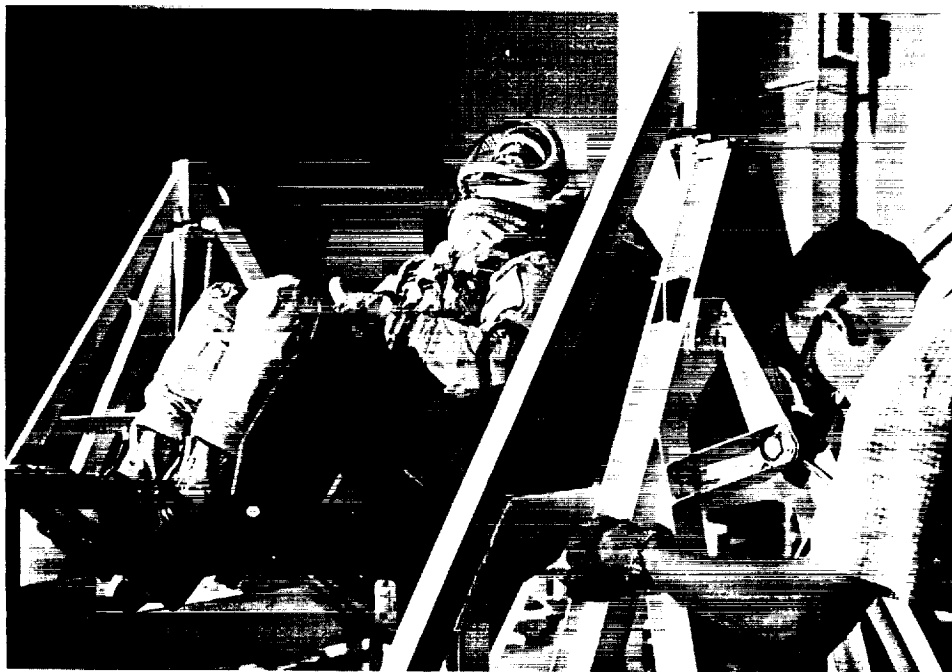

1965
May
13

The Wet Mock Simulated Launch (WMSL) of Gemini-Titan (GT) 4 was completed. The spacecraft was then demated from the launch vehicle in order to replace the batteries in the spacecraft adapter; flight seats were also installed and crew stowage evaluated. While this planned replacement was being carried out, the launch vehicle was the subject of a special tanking test (May 19) to determine the cause of the apparent loading inaccuracies that had turned up during WMSL. The problem was located in the stage II flowmeters, which were replaced (May 21) and checked out in a third tanking test (of stage II only) on May 27. In the meantime, launch vehicle and spacecraft were remated on May 22. The Simulated Flight Test of GT-4 on May 29 concluded prelaunch testing.

Mission Report for GT-IV, pp. 12-24, 12-27; Kuras and Albert, "Gemini Titan Technical Summary," p. 140.

15

Qualification of the G4C extravehicular suit was completed. This suit was basically the same as the G3C suit except for modifications which included a redundant zipper closure, two over-visors for visual and physical protection, automatic locking ventilation settings, and a heavier cover layer incorporating thermal and micrometeoroid protection. Six G4C suits would be at the launch site for the Gemini 4 flight crews by the end of May.

Quarterly Activity Report, Apr. 30, 1965, p. 38; Quarterly Status Report No. 13, p. 9.

Figure 99.—The hand-held maneuvering unit. (NASA Photo S-65-27331, June 2, 1965.)

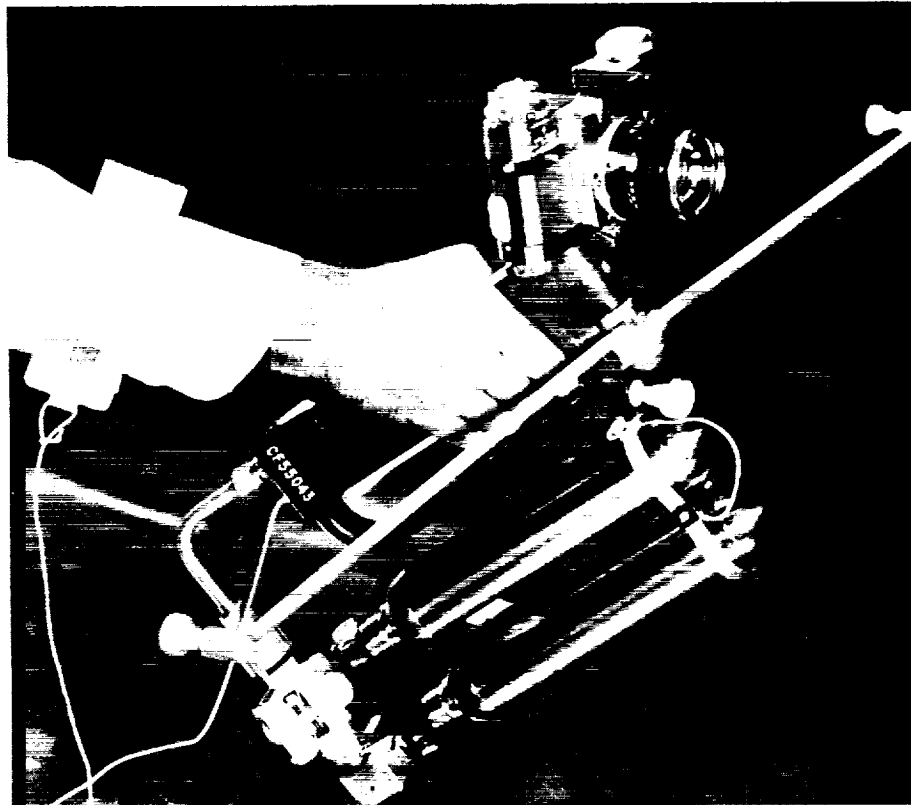

Gemini Agena target vehicle (GATV) 5002 completed final assembly and was transferred to systems test complex C-10 at Sunnyvale to begin Vehicle Systems Tests. The transfer had been scheduled for May 5 but was delayed by parts shortages, engineering problems, and considerable work backlog. The major source of delay was correcting a gap between the forward auxiliary rack and the vehicle; machining and aligning the rack and refinishing the scraped surfaces proved time-consuming. GATV 5002 was still short several items of command equipment. Systems testing began May 21.

1965
May
18

GATV Progress Report, May 1965, pp. 2-6, 2-8.

All extravehicular equipment planned for the Gemini 4 mission, including the ventilation control module, the extravehicular umbilical assembly, and the hand-held maneuvering unit, had been qualified. The flight hardware was at the launch site ready for flight at the end of May.

19

Quarterly Activity Report, July 31, 1965, p. 31; Quarterly Status Report No. 13, p. 10.

Figure 100.—Gemini spacecraft No. 5 undergoing clean-up prior to being shipped to Cape Kennedy. (NASA Photo S-65-5781, June 2, 1965.)

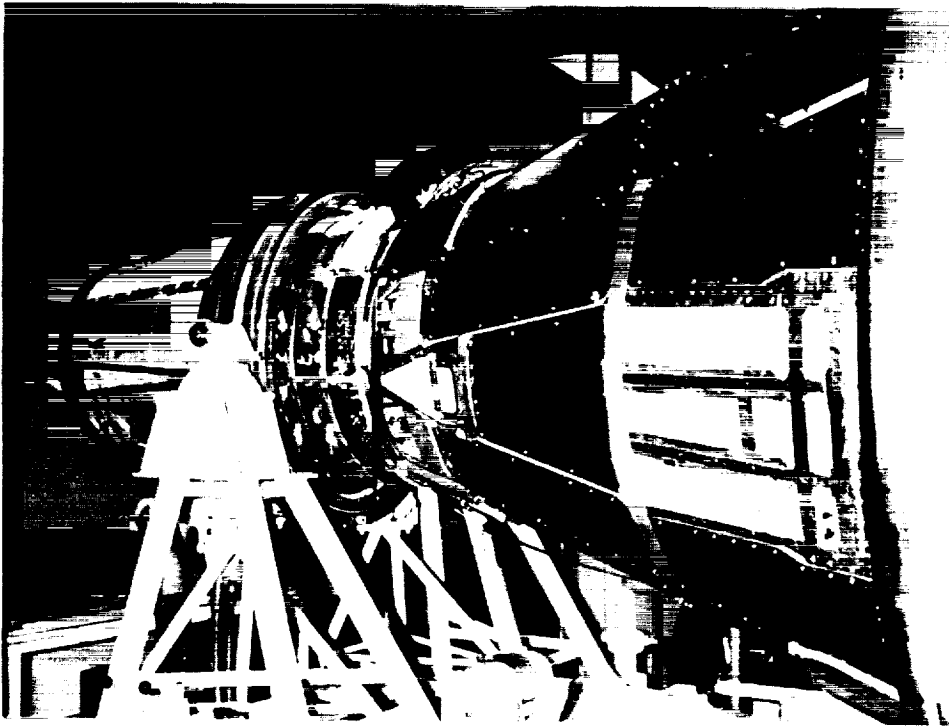

26

McDonnell began altitude chamber tests of Gemini spacecraft No. 5. Testing was interrupted by a fuel cell failure on June 1, and fuel sections were replaced. Modifications and preparations for retest concluded June 12, and an overall systems test with the fuel cell was conducted.

PROJECT GEMINI: A CHRONOLOGY

1965
May

Mission Report for GT-V, pp. 12-2, 12-3; Weekly Activity Reports: May 30-
June 5, p. 1; June 6-12, 1965, p. 1.

27

Air Force Space Systems Division (SSD), following standard Air Force acceptance procedure using DD Form 250, found Gemini Agena target vehicle (GATV) 5001 not acceptable because First Article Configuration Inspection (completed May 26) showed the vehicle not to be flightworthy as required by the contract. SSD nevertheless conditionally accepted delivery of GATV 5001; Lockheed was to correct deficiencies by the dates noted on DD-250 attachments. Besides several items of equipment merely awaiting final documentation, major items yet to be qualified were the shroud, primary and secondary propulsion systems, the command system, and components of the electrical power system. After being conditionally accepted, GATV 5001 was shipped by air to Eastern Test Range on May 28, arriving May 29.

Quarterly Status Report No. 13, p. 20; *GATV Progress Reports*: May, pp. 2-1, 2-2, 2-4, 4-1, 4-2; June 1965, p. 2-1.

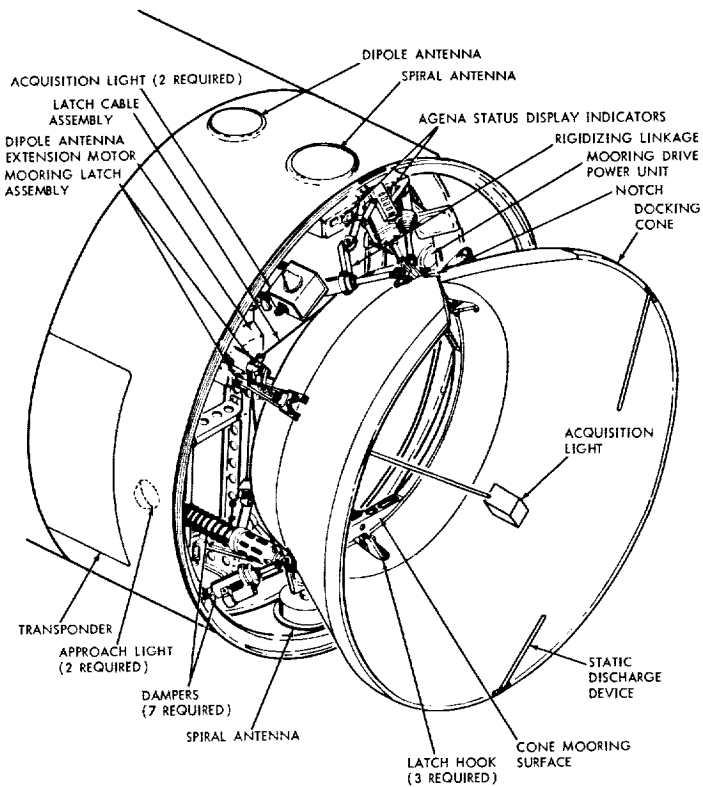

Figure 101.—Target Docking Adapter assembly. (McDonnell Report No. F169, Gemini Final Summary Report, Feb. 20, 1967, p. 548.)

29

Gemini Agena target vehicle 5001 arrived at Cape Kennedy following its conditional acceptance by the Air Force on May 27. It was moved to the Missile Assembly Building (Hangar E) for testing. The target vehicle was mated with target docking adapter No. 1 on June 18, and Combined Inter-

face Tests began June 19. Testing was completed July 8 with secondary propulsion system (SPS) functional and static leak checks, SPS installation and postinstallation checks, and thermal control surface preparation. Target vehicle 5001 was then transferred to complex 14 to be mated to target launch vehicle 5301.

1965
May

Weekly Activity Report, June 13-19, 1965, p. 1; *GATV Progress Reports*: June, pp. 2-2, 2-3; July 1965, p. 2-1; *Gemini-Titan II Air Force Launch Vehicle*, pp. 5-4, 5-5.

Figure 102(A).—Launch vehicle erector tower being lowered just prior to launch of Gemini-Titan 4. Difficulty in lowering the erector delayed the launch from the scheduled time of 9:00 a.m. to 10:16 a.m., e.s.t. (NASA Photo No. 65-H-934, released June 3, 1965.)



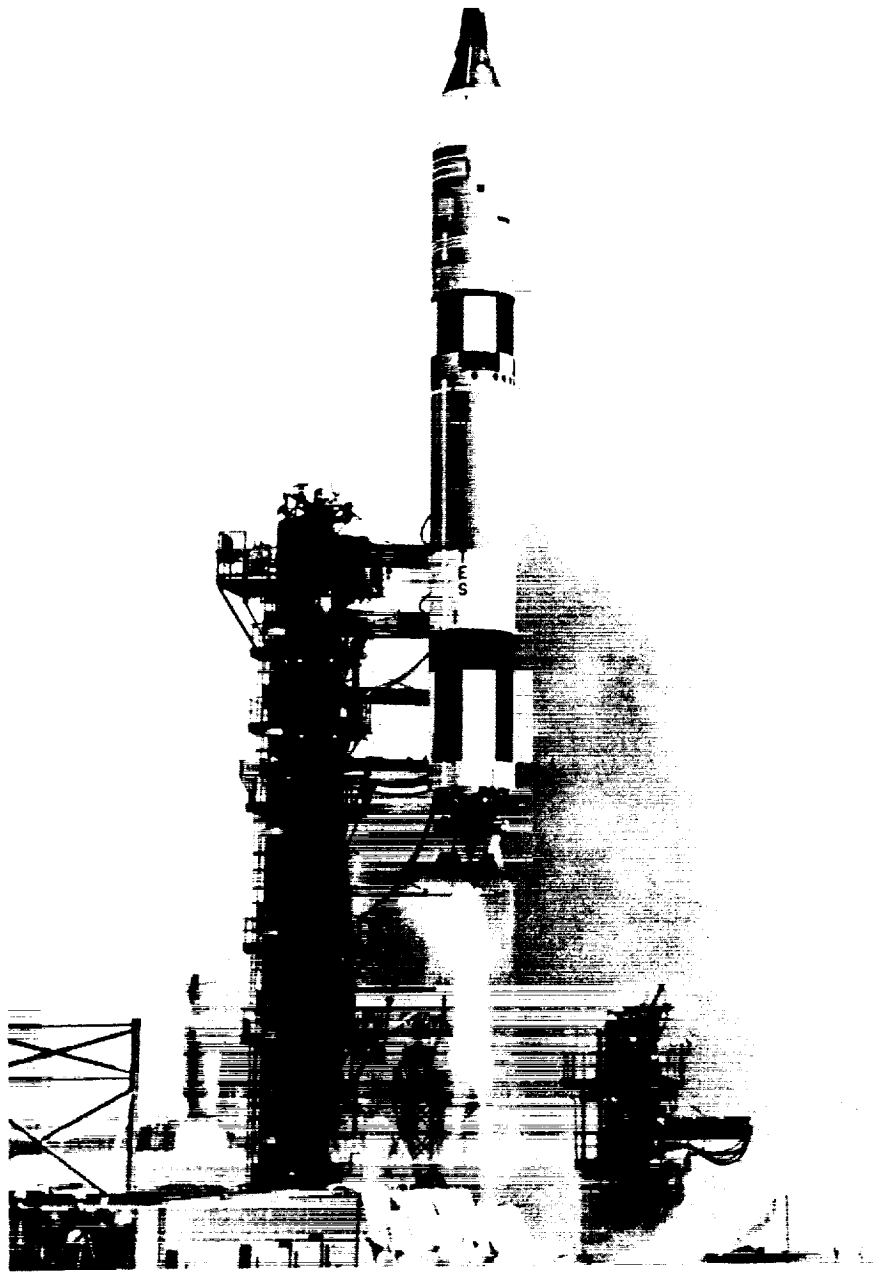

Figure 102 (B).—Gemini-Titan liftoff. (NASA Photo No. 65-H-934, released June 3, 1965.)

1965
June
3

Gemini 4, the second manned and first long-duration mission in the Gemini program, was launched from complex 19 at 10:16 a.m., e.s.t. Command pilot Astronaut James A. McDivitt and pilot Astronaut Edward H. White II were the crew. Major objectives of the four-day mission were demonstrating and evaluating the performance of spacecraft systems in a long-duration flight and evaluating effects on the crew of prolonged exposure to the space environment.

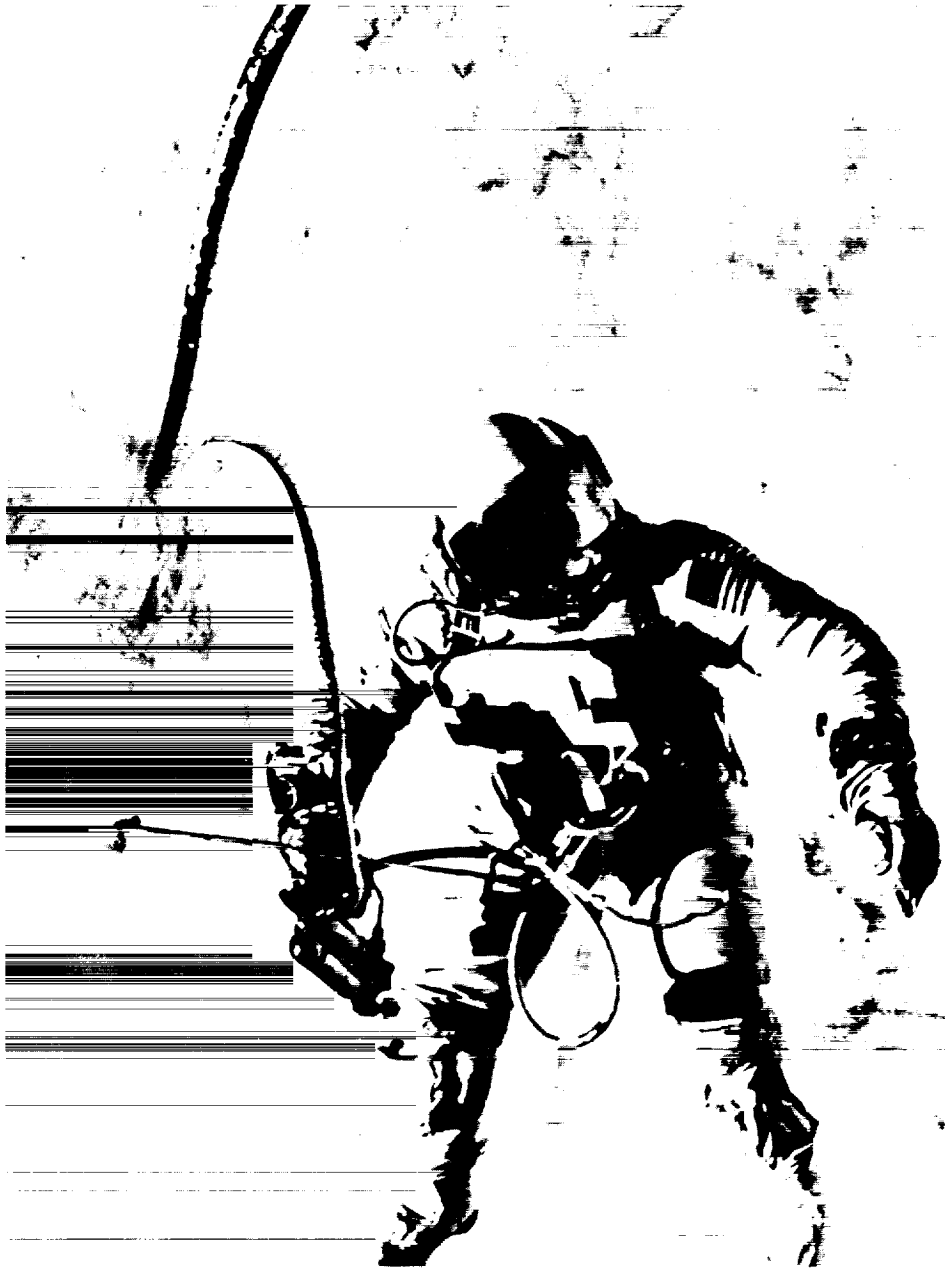

Figure 103.—Astronaut Edward H. White II during extravehicular activity on the Gemini-Titan 4 mission. (NASA Photo No. 65-H-1019, released June 3, 1965.)

Secondary objectives included demonstrating extravehicular activity (EVA) in space, conducting stationkeeping and rendezvous maneuvers with the second stage of the launch vehicle, performing significant in-plane and out-of-plane maneuvers, demonstrating the ability of the orbit attitude and maneuver sys-

*1965
June*

1965
June

tem (OAMS) to back up the retrorockets, and executing 11 experiments. The stationkeeping exercise was terminated at the end of the first revolution because most of the OAMS propellant allocated for the exercise had been used; further efforts would jeopardize primary mission objectives and could mean the cancellation of several secondary objectives. No rendezvous was attempted. The only other major problem to mar the mission was the inadvertent alteration of the computer memory during the 48th revolution in an attempt to correct an apparent malfunction. This made the planned computer-controlled reentry impossible and required an open-loop ballistic reentry. All other mission objectives were met. The flight crew began preparing for EVA immediately after terminating the stationkeeping exercise. Although preparations went smoothly, McDivitt decided to delay EVA for one revolution, both because of the high level of activity required and because deletion of the rendezvous attempt reduced the tightness of the schedule. Ground control approved the decision. The spacecraft hatch was opened at 4 hours 18 minutes into the flight and White exited 12 minutes later, using a hand-held maneuvering gun. White reentered the spacecraft 20 minutes after leaving it. The hatch was closed at 4 hours 54 minutes ground elapsed time. Drifting flight was maintained for the next two and one-half days to conserve propellant. The spacecraft landed in the Atlantic Ocean about 450 miles east of Cape Kennedy—some 40 miles from its nominal landing point—at 12:13 p.m., June 7. The crew boarded a helicopter 34 minutes after landing and was transported to the prime recovery ship, the aircraft carrier *Wasp*. Spacecraft recovery was completed at 2:28 p.m., a little more than 100 hours after *Gemini 4* had been launched. *Gemini 4* was the first mission to be controlled from the mission control center in Houston.

Mission Report for Gemini IV, pp. 1-1, 2-1, 2-2, 4-1, 4-2, 4-19, 6-11, 6-12; Quarterly Activity Report, July 31, 1965, p. 10.

- 7 Gemini launch vehicle (GLV) 5 was erected at complex 19. The vehicle was inspected and umbilicals connected June 9. Power was applied June 10. Subsystems Reverification Tests (SSRT) began June 14. SSRT was a simplified test program which replaced Subsystems Functional Verification Test (SSFVT). SSFVT, performed on the first four GLVs, repeated tests that had already been performed at Martin-Baltimore. SSRT simplified subsystems checkout by requiring only that the factory findings be reverified, rather than duplicated, for GLV-5 and all later launch vehicles. SSRT was completed June 28. The launch vehicle Combined Systems Test to verify its readiness for mating was run June 29.

Mission Report for GT-V, p. 12-7; Aerospace *Final Report*, p. II.F-2.

- 15 Systems assurance testing of Gemini spacecraft No. 6 was completed at McDonnell. Following validation of the environmental control system June 16-19, the spacecraft was prepared for Simulated Flight Test which began June 22

Mission Report for GT-VIA, p. 12-2.

- 18 Atlas standard launch vehicle 5301 was returned from Hangar J to complex 14 and once again erected. Booster Facility Acceptance Composite Test was completed July 9.

Weekly Activity Reports: June 13-19, p. 1; July 4-10, 1965, p. 1.

McDonnell delivered Gemini spacecraft No. 5 to Cape Kennedy. Industrial area activities were completed June 25. The spacecraft was moved to complex 19 and hoisted into position atop the launch vehicle June 26. Beginning with this spacecraft, the Premate Systems Tests and Premate Simulated Flight Test were combined to form the Premate Verification Test, which was performed on all subsequent spacecraft. The Premate Verification Test of spacecraft No. 5 was conducted June 30–July 2.

1965
June
19

Mission Report for GT-V, p. 12-4; Weekly Activity Reports: June 13-19, p. 1; June 20-26, 1965, p. 1; *Gemini Midprogram Conference*, pp. 222-223.

The Simulated Flight Test of Gemini spacecraft No. 6 was completed at McDonnell. The spacecraft was cleaned up and moved to the altitude chamber, where it underwent phasing checks and was prepared for chamber testing. These activities were completed July 15, and altitude chamber tests were conducted July 16-21. The spacecraft was deserviced, realigned, and prepared for shipment to Cape Kennedy.

25

Mission Report for GT-VIA, p. 12-2; Weekly Activity Reports: June 20-26, p. 1; July 18-24, 1965, p. 1.

The Combined Systems Acceptance Test of Gemini launch vehicle (GLV) 6 was completed at Martin-Baltimore. The vehicle acceptance team convened July 6 to review GLV-6 and accepted it July 10. The vehicle was demated on July 19 and formally accepted by the Air Force July 31. Stage II was delivered to Cape Kennedy the same day, and stage I on August 2. Both stages were then placed in storage pending the launch of Gemini-Titan 5.

25

Mission Report for GT-VIA, pp. 12-7, 12-8; Weekly Activity Report, Aug. 1-7, 1965, p. 1; *Aerospace Final Report*, p. II.G-5; *Gemini-Titan II Air Force Launch Vehicle*, p. D-11.

Stage I of Gemini launch vehicle (GLV) 7 was erected in the east cell of the vertical test facility at Martin-Baltimore. Stage II was erected June 28. GLV-7 was inspected and prepared for testing while GLV-6 was undergoing vertical tests in the west cell. Power was applied to GLV-7 for the first time July 26. Subsystems Functional Verification Tests were completed August 25. Systems modification and retesting followed.

25

Mission Report for GT-VII, p. 12-6; *Aerospace Final Report*, p. II.G-5; *Gemini-Titan II Air Force Launch Vehicle*, p. D-13.

McDonnell concluded manufacturing, module tests, and equipment installation for Gemini spacecraft No. 7. The reentry and adapter assemblies were mated July 26 to complete final assembly of the spacecraft. Preparing the spacecraft for test lasted until August 4, when systems assurance testing began.

29

Mission Report for GT-VII, p. 12-2.

Gemini Agena target vehicle 5002 completed Vehicle Systems Tests at Sunnyvale, and the final acceptance test was conducted. The vehicle was disconnected from the test complex on July 13, after NASA, Air Force Space Systems Division, Aerospace, and Lockheed representatives agreed that all data discrepancies from the final systems tests had been resolved.

30

GATV Progress Reports: June, pp. 2-4, 2-6, 2-7; July 1965, p. 2-7.

1965
July
1

George E. Mueller, NASA Associate Administrator for Manned Space Flight, established an "Operations Executive Group" composed of senior executives of government and contractor organizations participating in manned space flight operations. The group would review Gemini and Apollo program status, resource requirements, management, and flight operations to provide executive management with background needed for effective policy decisions. A second purpose was ensuring that the executives knew each other well enough to work directly in solving time-critical problems rapidly. One-day meetings were to be held at intervals of two to four months.

Letter, Mueller to Gilruth, July 1, 1965.

1

NASA announced that Frank Borman and James A. Lovell, Jr., had been selected as the prime flight crew for Gemini VII. The backup crew for the flight, which would last up to 14 days, would be Edward H. White II and Michael Collins.

Astronautics and Aeronautics, 1965, p. 308.



Figure 104.—Rendezvous evaluation pod installed in the equipment section of Gemini spacecraft No. 5 before launch vehicle mating. (NASA Photo S-65-41884, July 6, 1965.)

7

Gemini launch vehicle (GLV) 5 and spacecraft No. 5 were mechanically mated at complex 19. The Electrical Interface Integrated Validation and Joint Guidance and Control Test began immediately and was completed July 9. The spacecraft/GLV Joint Combined Systems Test followed on July 12. The Flight Configuration Mode Test completed systems testing on July 16.

Mission Report for GT-V, p. 12-7.

Gemini Agena target vehicle 5001 completed systems tests in Hangar E and was transferred to complex 14, where it was mated to Atlas standard launch vehicle 5301. Tests began in preparation for a Simultaneous Launch Demonstration on July 22.

1965
July
8

Weekly Activity Reports: July 4-10, p. 1; July 18-24, 1965, p. 1; *GATV Progress Report*, July 1965, p. 2-1.

NASA Headquarters Gemini Program Office informed Manned Spacecraft Center that it had decided to delete extravehicular activity from Gemini missions 5, 6, and 7.

12

Message, Schneider to Mathews, Subj: Deletion of EVA, July 12, 1965.

A Simultaneous Launch Demonstration (SLD) was conducted between the Gemini Atlas-Agena target vehicle on complex 14 and Gemini-Titan (GT) 5 on complex 19, in conjunction with the Wet Mock Simulated Launch (WMSL) of GT-5. The Gemini launch vehicle tanking exercise, normally a part of WMSL, was conducted separately for convenience on July 17. SLD was a dress rehearsal to demonstrate the coordination required to conduct a single countdown on two vehicles and was subsequently performed on all rendezvous missions. The mission control centers at Houston and the Cape, as well as Eastern Test Range support facilities, were integral parts of the combined countdown. A failure in the Houston computer system caused several spurious commands to be transmitted to the target vehicle. Although some of these commands were accepted, results were not serious because they were mostly stored program command loads. Following SLD, the Atlas and Agena were demated on July 26.

22

Mission Report for GT-V, p. 12-7; Weekly Activity Reports: July 18-24, p. 1; July 25-31, 1965, p. 1; Quarterly Status Report No. 14 for Period Ending Aug. 31, 1965, p. 18; Abstract of Meeting on Atlas/Agena Coordination, Aug. 20, 1965; *Aerospace Final Report*, pp. II.F-3, II.F-4, III.F-4, III.F-5; *GATV Progress Report*, July 1965, pp. 2-1, 2-3, 2-4.

Air Force Space Systems Division formally accepted delivery of Gemini Agena target vehicle (GATV) 5002 after the vehicle acceptance team inspection had been completed. The vehicle was then shipped by air to Eastern Test Range on July 24, arriving July 25. Although GATV 5002 was accepted, several items of equipment remained in "not qualified" status, including the shroud, secondary and primary propulsion systems, and components of both the electrical power and command systems.

23

Weekly Activity Report, July 25-31, 1965, p. 1; *GATV Progress Report*, July 1965, pp. 2-7, 4-11, 4-12.

Gemini-Titan (GT) 5 was demated following the completion of the Wet Mock Simulated Launch to allow the spacecraft fuel cells to be replaced and the coolant bypass to be modified. Spacecraft and launch vehicle were remated August 5. Modified Electrical Interface Integrated Validation and the Joint Guidance and Control Tests were run on August 6. Spacecraft Final Systems Test on August 9-10 and the Simulated Flight Test on August 13 completed prelaunch testing of GT-5, scheduled for launch August 19.

23

Mission Report for GT-V, pp. 12-4, 12-5, 12-7.



Figure 105.—Astronauts Charles Conrad Jr., and L. Gordon Cooper, Jr., practice procedures for getting into their spacecraft in the Gemini 5 Wet Mock Simulated Launch. (NASA Photo S-65-41895, July 22, 1965.)

1965
July
23

Standard Agena D (AD-108), which had been completed in June and held in storage, was transferred to Building 104 at Sunnyvale for modification and final assembly as Gemini Agena target vehicle 5003. While in storage, several

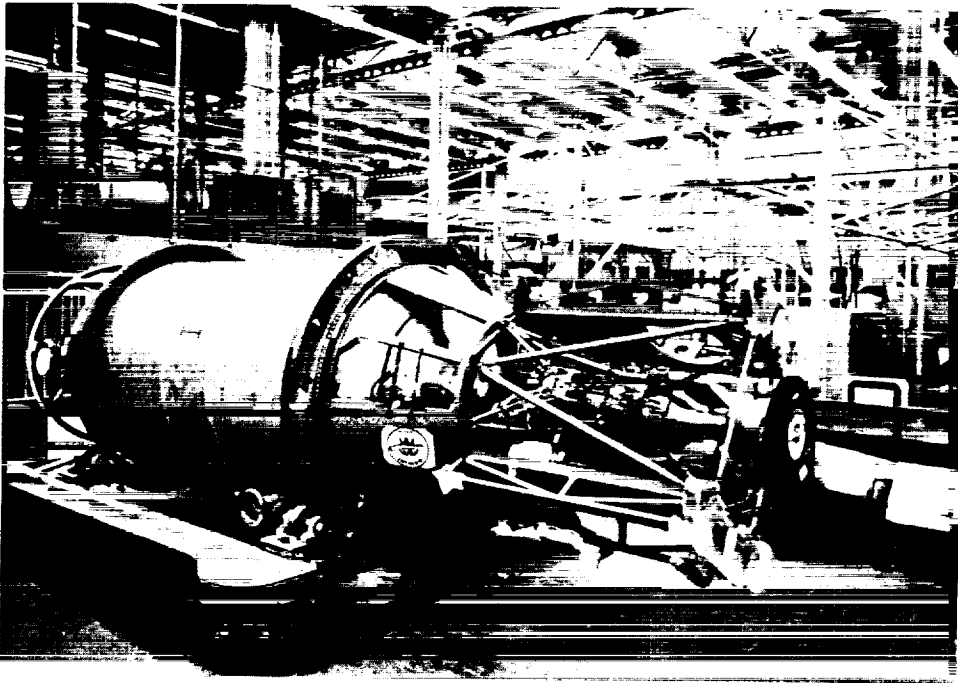

Figure 106.—Standard Agena D 108 being delivered to final assembly area. (NASA S-65-8066, July 23, 1965.)

pieces of AD-108 equipment had been removed for modification to the Gemini configuration. Final assembly began August 8.

1965
July

GATV Progress Reports: June, pp. 2-8, 2-9; July 1965, pp. 2-10, 2-11.

Atlas standard launch vehicle 5301 and Gemini Agena target vehicle (GATV) 5001 were demated at complex 14, following the Simultaneous Launch Demonstration of July 22. GATV 5001 was returned to Hangar E, where it was stored as the backup vehicle for GATV 5002. On August 18, GATV 5002 was officially designated as the target vehicle for Gemini VI, the first rendezvous mission, while GATV 5001 was to be maintained in flight-ready condition as backup. Atlas 5301, which had been returned to Hangar J after demating, was moved back to complex 14 on August 16 to serve as the target launch vehicle for GATV 5002.

26

Weekly Activity Report, July 25-31, 1965, p. 1; Quarterly Status Report No. 14, p. 18; Abstract of Meeting on Atlas/Agena Coordination, Aug. 20, 1965; *GATV Progress Report*, August 1965, p. 2-1.

Gemini Program Manager Charles W. Mathews initiated a spacecraft manager program by assigning one engineer to Gemini spacecraft No. 5 and another to spacecraft No. 6. Assignments to other spacecraft would come later. Following the precedent established in Mercury and then in Gemini by Martin, McDonnell, and Aerojet-General, one man would follow the spacecraft from manufacturing through testing to launch, serving as a source of up-to-date information on his spacecraft and calling attention to particular problem areas.

27

PROJECT GEMINI: A CHRONOLOGY

- 1965 Memo, Mathews to Gilruth *et al.*, Subj: Assignment of Spacecraft engineer to each spacecraft, July 27, 1965.
- August
4 McDonnell delivered Gemini spacecraft No. 6 to Cape Kennedy. Industrial area activities during the next three weeks included pyrotechnics buildup and spacecraft modifications. The spacecraft was moved to Merritt Island Launch Area for Plan X integrated tests with the target vehicle during the last week of August.
Mission Report for GT-VIA, p. 12-4.
- 5 Atlas standard launch vehicle 5302 was shipped from San Diego by truck, arriving at Cape Kennedy August 11. The vehicle had come off the production line and been delivered to the Gemini program on April 2. Final assembly had been completed May 25, installation of flight equipment and Gemini-peculiar kit June 3, and factory testing July 22. Air Force Space Systems Division had formally accepted the vehicle on July 29.
Mission Report for GT-VIII, pp. 12-12, 12-13; Weekly Activity Reports: Aug. 1-7, p. 1; Aug. 8-14, 1965, p. 1; Quarterly Status Report No. 14, p. 21.
- 12 McDonnell finished systems assurance testing of Gemini spacecraft No. 7. Validation of the environmental control system concluded August 19, and preparations were started for the Simulated Flight Test which began August 26.
Mission Report for GT-VII, p. 12-2.
- 12 Gemini Program Office informed the NASA-McDonnell Management Panel of the decision to fly the new, lightweight G5C space suit on Gemini VII. Tested by Crew Systems Division, the suit displayed a major improvement in comfort and normal mobility without sacrificing basic pressure integrity or crew safety. The suit weighed about nine pounds and was similar to the G4C suit except for the elimination of the restraint layer and the substitution of a soft helmet design with an integral visor and no neckring. Under study was the possibility of allowing one or both astronauts to remove their suits during the mission. NASA Headquarters, on July 2, had directed that the flight crew not use full pressure suits during the Gemini VII mission.
Memo, Mathews to Gilruth *et al.*, Subj: Suit Configuration for Gemini VII, July 27, 1965; MSC Minutes of Senior Staff Meetings: Aug. 6, p. 1; Aug. 13, 1965, p. 1; Minutes of NASA-MAC Management Panel Meeting held at MSC, Aug. 12, 1965; Quarterly Status Report No. 14, p. 9.
- 16 Martin-Baltimore received propellant tanks for Gemini launch vehicle (GLV) 9 from Martin-Denver, which had begun fabricating them February 25. These were the first GLV tanks to be carried by rail from Denver to Baltimore. All previous tanks had traveled by air, but shortage of suitable aircraft made the change necessary. The tanks were shipped August 9. Aerojet-General delivered the stage I engine for GLV-9 August 20 and the stage II engine September 22. Tank splicing was completed October 21, engine installation November 10. Horizontal testing concluded November 23.
Gemini Program Mission Report, Gemini IX-A, updated, p. 12-6; Aerospace *Final Report*, p. II.G-7; *Gemini-Titan II Air Force Launch Vehicle*, p. D-15.

A spacecraft computer malfunction caused a hold of the countdown 10 minutes before the scheduled launch of Gemini-Titan 5. While the problem was being investigated, thunderstorms approached the Cape Kennedy area. With the computer problem unresolved and the weather deteriorating rapidly, the mission was scrubbed and rescheduled for August 21. Recycling began with unloading propellants.

1965
August
19

Mission Report for GT-V, pp. 5-129, 12-5; Kuras and Albert, "Gemini-Titan Technical Summary," p. 142.

Lockheed conducted shroud separation tests at its Rye Canyon Research Center. Tests comprised four separations at simulated altitudes, all successful. After test data had been analyzed, the shroud was judged to be flightworthy.

19-24

GATV Progress Reports: August, pp. 2-12, 2-17, 3-13; September 1965, p. 2-12.



Figure 107.—Christopher C. Kraft, Jr., Robert R. Gilruth, and George M. Low in the Houston Mission Control Center when falling pressure in the oxygen supply tank of the fuel cell threatened the Gemini V mission. (NASA Photo S-65-28691, Aug. 22, 1965.)

Gemini 5 was launched from complex 19 at 9:00 a.m., e.s.t. The crew comprised command pilot Astronaut L. Gordon Cooper, Jr., and pilot Astronaut Charles Conrad, Jr. Major objectives of the eight-day mission were evaluating the performance of the rendezvous guidance and navigation system, using a rendezvous evaluation pod (REP), and evaluating the effects of prolonged exposure to the space environment on the flight crew. Secondary objectives included demonstrating controlled reentry guidance, evaluating fuel cell performance, demonstrating all phases of guidance and control system operation needed for a rendezvous mission, evaluating the ca-

21

1965
August

pability of either pilot to maneuver the spacecraft in orbit to rendezvous, evaluating the performance of rendezvous radar, and executing 17 experiments. The mission proceeded without incident through the first two orbits and the ejection of the REP. About 36 minutes after beginning evaluation of the rendezvous guidance and navigation system, the crew noted that the pressure in the oxygen supply tank of the fuel cell system was falling. Pressure dropped from 850 pounds per square inch absolute (psia) at 26 minutes into the flight until it stabilized at 70 psia at 4 hours 22 minutes, and gradually increased through the remainder of the mission. The spacecraft was powered down and the REP exercise was abandoned. By the seventh revolution, experts on the ground had analyzed the problem and a powering-up procedure was started. During the remainder of the mission the flight plan was continuously scheduled in real time. Four rendezvous radar tests were conducted during the mission, the first in revolution 14 on the second day; the spacecraft rendezvous radar successfully tracked a transponder on the ground at Cape Kennedy. During the third day, a simulated Agena rendezvous was conducted at full electrical load. The simulation comprised four maneuvers—apogee adjust, phase adjust, plane

Figure 108.—Photograph of the Florida peninsula taken from the Gemini 5 spacecraft, looking south along the east coast, with Cape Kennedy in the foreground projecting into the Atlantic Ocean. (NASA Photo S-65-45388, Aug. 21-29, 1965.)

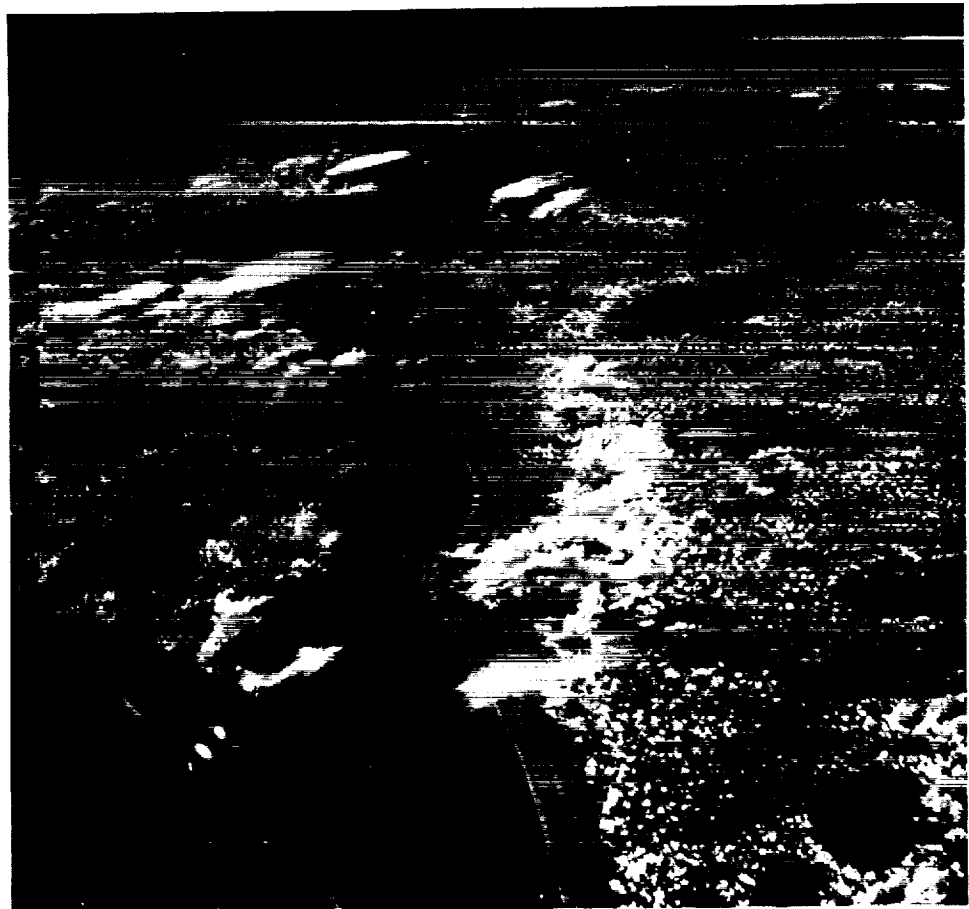

1965
August

change, and coelliptical maneuver—using the orbit attitude and maneuver system (OAMS). Main activities through the fourth day of the mission concerned operations and experiments. During the fifth day, OAMS operation became sluggish and thruster No. 7 inoperative. Thruster No. 8 went out the next day, and the rest of the system was gradually becoming more erratic. Limited experimental and operational activities continued through the remainder of the mission. Retrofire was initiated in the 121st revolution during the eighth day of the mission, one revolution early because of threatening weather in the planned recovery area. Reentry and landing were satisfactory, but the landing point was 89 miles short, the result of incorrect navigation coordinates transmitted to the spacecraft computer from the ground network. Landing occurred at 7:56 a.m., August 29, 190 hours 55 minutes after the mission had begun. The astronauts arrived on board the prime recovery ship, the aircraft carrier *Lake Champlain*, at 9:25. The spacecraft was recovered at 11:51 a.m.

Mission Report for GT-V, pp. 1-1, 1-2, 2-1, 2-2, 4-1 through 4-7, 5-68, 5-69; Fact Sheet 291-C, *Gemini 5 Flight*, October 1965; McDonnell *Final Report*, pp. 68-69.

Gemini Agena target vehicle 5002 completed preliminary systems testing at Hangar E and was transferred to Merritt Island Launch Area, where it was joined by spacecraft No. 6 for Plan X testing. After ground equipment checks, Plan X tests proceeded on August 25. No significant interference problems were found, and testing ended on August 31.

23

Quarterly Status Report No. 14, pp. 18-19; *GATV Progress Report*, August 1965, p. 2-3.

Stage I of Gemini launch vehicle (GLV) 6 was erected at complex 19. Stage II was erected the following day. Umbilicals were connected and inspected September 1, and Subsystems Reverification Tests began September 2. These tests were completed September 15. The Prespacecraft Mate Verification Test of GLV-6 was run September 16.

30

Mission Report for GT-VIA, p. 12-8; *Gemini-Titan II Air Force Launch Vehicle*, p. D-11.

The Simulated Flight Test of Gemini spacecraft No. 7 ended at McDonnell. The spacecraft was cleaned up and moved to the altitude chamber September 9. Phasing checks were conducted September 10-11, and the spacecraft was prepared for altitude chamber tests, which began September 13. Chamber tests concluded September 17. The spacecraft was deserviced, updated, retested, and prepared for shipment to Cape Kennedy.

30

Mission Report for GT-VII, p. 12-2; Weekly Activity Report, Sept. 5-11, 1965, p. 1.

Gemini Program Office reported that during the missions of *Gemini 4* and *5*, skin-tracking procedures had been successfully developed. On these missions, the C-band radars were able to track the spacecraft in both the beacon and skin-track mode. It was, therefore, possible to obtain tracking data when the spacecraft was powered down and had no tracking beacons operating. As a result, the skin-tracking procedures were integrated into the network support for all remaining Gemini missions.

31

Quarterly Status Report No. 14, p. 24.

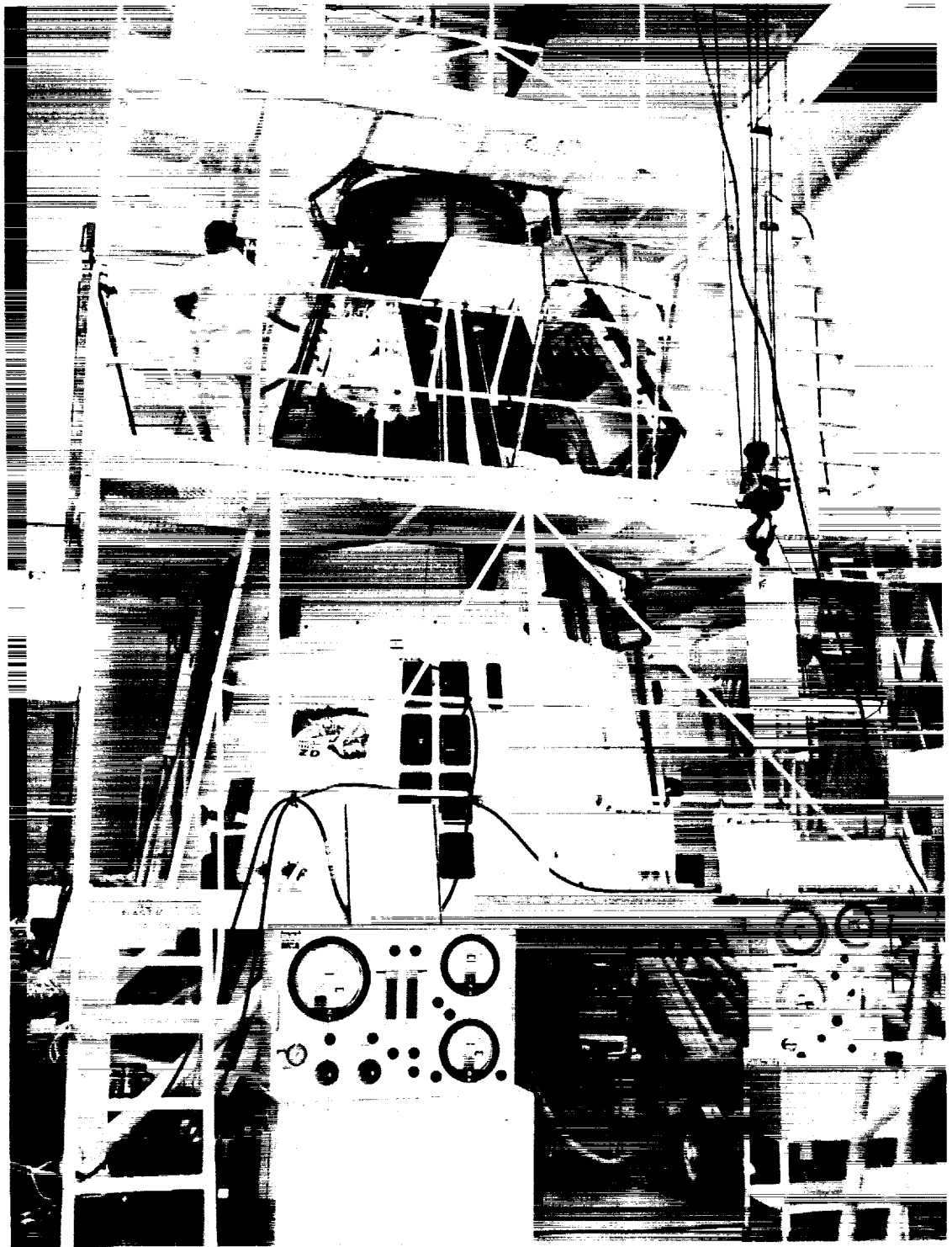

Figure 109.—Gemini spacecraft No. 7 in final shakedown in the clean room at McDonnell. (NASA Photo S-65-54127, Sept. 29, 1965.)

1965
September
1

Final troubleshooting on Gemini Agena target vehicle (GATV) 5002 after Plan X testing at Merritt Island Launch Area (MILA) was completed. The next day GATV 5002 was returned to Hangar E from MILA, where it began a series of tests to verify the operational readiness of all vehicle systems prior to erection and mating with the launch vehicle.

Aerospace *Final Report*, p. III.F-4; *GATV Progress Report*, September 1965, p. 2-1.

Representatives of Air Force Space Systems Division, Aerospace, and Lockheed attended a technical review of the flight verification test program for the oxidizer gas generator solenoid valve. This was the last remaining component of the Agena primary propulsion system needing test qualification. Testing had been completed August 26; disassembly, inspection, and evaluation were concluded September 3. The consensus of those attending was that the successful test program had demonstrated flightworthiness of this configuration. This concluded qualification of all propulsion system components.

8

Quarterly Status Report No. 14, p. 19; *GATV Progress Report*, September 1965, p. 2-14.

Gemini spacecraft No. 6 was moved to complex 19 and hoisted to the top of the launch vehicle. The move had been scheduled for September 2 but was delayed by the presence of Hurricane Betsy in the vicinity of the Cape September 3-8. The Prespacecraft Mate Verification Test was conducted September 13-16. Preparations then began for mating the spacecraft to the launch vehicle.

9

Mission Report for GT-VIA, p. 12-4; Weekly Activity Reports: Aug. 29-Sept. 4, pp. 1-2; Sept. 5-11, 1965, p. 1.

Martin-Denver shipped the propellant tanks for Gemini launch vehicle (GLV) 10 to Martin-Baltimore. During the rail trip, leaking battery acid corroded the dome of the stage II fuel tank. The tanks arrived at Martin-Baltimore September 21. The stage II fuel tank was rejected and returned to Denver. It was replaced by the stage II fuel tank from GLV-11, which completed final assembly September 25 and arrived in Baltimore November 3 after being inspected and certified. Fabrication of GLV-10 tanks had begun in April.

16

Gemini Program Mission Report, Gemini X, undated, p. 12-6; Aerospace *Final Report*, p. II.G-7; Harris, *Gemini Launch Vehicle Chronology*, p. 53.

Gemini launch vehicle (GLV) 6 and spacecraft No. 6 were mechanically mated at complex 19. The Electrical Interface Integrated Validation and Joint Guidance and Control Test was completed September 21. The spacecraft/GLV Joint Combined Systems Test was run September 23. GLV tanking test was performed September 29 and the Flight Configuration Mode Test October 1, completing systems testing for Gemini-Titan 6.

17

Mission Report for GT-VIA, pp. 12-4, 12-8.

McDonnell completed mating the reentry and adapter assemblies of spacecraft No. 8. The complete spacecraft was aligned and adjusted. Systems Assurance Tests began September 30.

20

Mission Report for GT-VIII, p. 12-2.



Figure 110.—Gemini spacecraft No. 8 in clean room at McDonnell for systems validation testing. (NASA Photo S-65-54125, Sept. 29, 1965.)

The Combined Systems Acceptance Test of Gemini launch vehicle (GLV) 7 was completed in the vertical test facility at Martin-Baltimore. Inspection of GLV-7 by the vehicle acceptance team began September 27 and ended October 1, with the vehicle found acceptable. GLV-7 was deerectioned October 5 and formally accepted by the Air Force October 15. Stage I was airlifted to Cape Kennedy October 16, followed by stage II October 18. Both stages were placed in storage pending the launch of the Gemini VI mission.

1965
September
20

Mission Report for GT-VII, pp. 12-6, 12-7; Aerospace *Final Report*, p. II.G-5; *Gemini-Titan II Air Force Launch Vehicle*, p. D-13; Harris, *Gemini Launch Vehicle Chronology*, p. 54.

Manned Spacecraft Center announced that Neil A. Armstrong would be command pilot and David R. Scott would be pilot for Gemini VIII. Backup crew would be Charles Conrad, Jr., and Richard F. Gordon, Jr. Gemini VIII would include practice on rendezvous and docking maneuvers and a space walk that could last as long as one Earth orbit, about 95 minutes.

20

Astronautics and Aeronautics, 1965, p. 444.

Gemini launch vehicle (GLV) 8 was erected in the west cell of the vertical test facility at Martin-Baltimore. Power was applied to the vehicle October 13, following the deerection of GLV-7. Subsystems Functional Verification Tests of GLV-8 were completed November 4.

28

Mission Report for GT-VIII, p. 12-6; Aerospace *Final Report*, p. II.G-5; *Gemini-Titan II Air Force Launch Vehicle*, p. D-14.

Gemini Agena target vehicle 5002 was transported to complex 14 and mated to target launch vehicle 5301. Preliminary checks were followed, on October 4, by the Joint Flight Acceptance Composite Test (J-FACT). J-FACT was a combined check of all contractors, the range, the vehicles, and aerospace ground equipment in a simulated countdown and flight; propellants and high pressure gases were not loaded, nor was the gantry removed. Simultaneous Launch Demonstration was successfully completed October 7.

October
1

Quarterly Status Report No. 15 for Period Ending Nov. 30, 1965, p. 18; Aerospace *Final Report*, pp. III.F-4, III.G-3; *GATV Progress Report*, October 1965, pp. 2-1, 2-2.

The final design review for the Gemini Atlas-Agena target vehicle ascent guidance equations was held. The equations, using target launch vehicle pitch and yaw steering and Gemini Agena target vehicle nodal steering, were found to have been adequately tested and well within required accuracy limits. The equations were approved as ready for flight.

6

Quarterly Status Report No. 15, p. 19.

The Wet Mock Simulated Launch (WMSL) of Gemini-Titan (GT) 6 and the Simultaneous Launch Demonstration with GT-6 and the Gemini Atlas-Agena target vehicle were conducted. Following WMSL, the spacecraft and launch vehicle were demated to allow the spacecraft battery to be replaced. They were remated October 8-13. Spacecraft Systems Test was completed October 15. Pre-launch testing concluded October 20 with the Simulated Flight Test.

7

Mission Report for GT-VIA, pp. 12-4, 12-8.

PROJECT GEMINI: A CHRONOLOGY

1965
October
9

McDonnell delivered Gemini spacecraft No. 7 to Cape Kennedy. Industrial area activities, including pyrotechnics buildup, fuel cell installation, and modification of the water management system, were completed October 29. The spacecraft was moved to complex 19 and hoisted atop the launch vehicle. The Prespacecraft Mate Verification Test, including activation and deactivation of the fuel cell, was conducted November 1-5.

Mission Report for GT-VII, p. 12-4.

14

Gemini Agena target vehicle 5003 was transferred to Vehicle Systems Test after completing final assembly on October 9. Testing began October 18.

GATV Progress Report, October 1965, p. 2-4.

20

Systems testing at complex 14 of the Gemini Atlas-Agena target vehicle for Gemini VI was completed with a launch readiness demonstration. Final vehicle closeout and launch preparations began October 21 and continued until final countdown on October 25.

Aerospace Final Report, p. III.F-5; *GATV Progress Report*, October 1965, p. 2-3.

22

McDonnell completed Systems Assurance Tests of spacecraft No. 8 and validation of the spacecraft environmental control system. The spacecraft simulated flight was conducted October 26-November 4.

Mission Report for GT-VIII, p. 12-2.

25

The Gemini VI mission was canceled when Gemini Agena target vehicle (GATV) 5002 suffered what appeared to be a catastrophic failure shortly after separating from the Atlas launch vehicle. The Gemini Atlas-Agena target vehicle was launched from complex 14 at 10:00 a.m., e.s.t. When the two vehicles separated at 10:05, all signals were normal. But approximately 375 seconds after liftoff, vehicle telemetry was lost and attempts to reestablish contact failed. The Gemini VI countdown was held and then canceled at 10:54 a.m., because the target vehicle had failed to achieve orbit. In accordance with Air Force Space Systems Division (SSD) procedures and NASA management instructions—both of which specified investigation in the event of such a failure—Major General Ben I. Funk, SSD Commander, reconvened the Agena Flight Safety Review Board, and NASA established a GATV Review Board.

Quarterly Status Report No. 15, pp. 21, 23-24; memo, Seamans to Mueller, Subj: Gemini VI Mission Failure Investigation, Oct. 27, 1965; letter, Mueller to Gilruth, Oct. 29, 1965, with enc., "Gemini Agena Target Vehicle (GATV) Review Board," same date; MSC Fact Sheet 291-D, *Gemini VII/VI, Long Duration/Rendezvous Mission*, January 1966; *GATV Progress Report*, October 1965, p. 2-1.

27

NASA Associate Administrator Robert C. Seamans, Jr., informed George E. Mueller, Associate Administrator for Manned Space Flight, that the catastrophic anomaly of Gemini Agena target vehicle (GATV) 5002 on October 25 had been defined as a mission failure. Accordingly, Seamans asked Mueller to establish a GATV Review Board to investigate all aspects of the Agena failure, managerial as well as technical. Manned Spacecraft Center Director Robert R. Gilruth and Major General O. J. Ritland, Deputy Commander for Space, Air Force Systems Command, were designated cochairmen of the review board.

Primary responsibility for determining the cause of failure lay with Air Force Space Systems Division, which would make its findings available to the board.

1965
October

Quarterly Status Report No. 15, p. 21; memo, Seamans to Mueller, Subj: Gemini . . . Investigation, Oct. 27, 1965; letter, Mueller to Gilruth, Oct. 27, 1965, with enc., same date.

The White House announced that NASA would attempt to launch Gemini VI while Gemini VII was in orbit. The original Gemini VI mission had been canceled when its target vehicle failed catastrophically on October 25. In a memorandum to the President, NASA Administrator James E. Webb indicated the possibility that Gemini VI spacecraft and launch vehicle could be reerected shortly after the launch of Gemini VII. Since much of the prelaunch checkout of Gemini VI would not need repeating, it could be launched in time to rendezvous with Gemini VII (a mission scheduled for 14 days) if launching Gemini VII did not excessively damage the launch pad. NASA officials, spurred by suggestions from Walter F. Burke and John F. Yardley of McDonnell, began discussing the possibility of a dual mission immediately after the failure October 25, drawing on some six months of discussion and preliminary planning by NASA, Air Force, Martin, and McDonnell personnel for a rapid manned flight launch demonstration.

28

News Conference #176-A at the White House (Austin, Texas) with William D. Moyers, 10:30 a.m., c.s.t., Oct. 28, 1965; memo, Webb to the President for use in announcement, Oct. 27, 1965; Low interview; interviews: Col. John G. Albert, Patrick AFB, Fla., May 26, 1967; Walter J. Kapryan, Cape Kennedy, May 25, 1967; Raymond D. Hill, Titusville, Fla., May 23, 1967.

Gemini spacecraft No. 6 and the second stage of Gemini launch vehicle (GLV) 6 were deerectioned and removed from complex 19. GLV-6 stage I was deerectioned the next day. The GLV was placed in storage at the Satellite Checkout Building under guard, in an environment controlled for temperature and humidity. Bonded storage maintained the integrity of previously conducted tests to reduce testing that would have to be repeated. Spacecraft No. 6 was stored in the Pyrotechnics Installation Building at the Merritt Island Launch Area.

28

Mission Report for GT-VIA, pp. 12-5, 12-9; Kuras and Albert, "Gemini-Titan Technical Summary," pp. 143-144; interview, Simpkinson, Houston, Oct. 13, 1967.

The major portion of 819 discrepancies remaining from the First Article Configuration Inspection (FACI) of Gemini Agena target vehicle 5001 in June were cleared; 128 that had not been applied against the acceptance document (DD-250) remained. All subsystem FACI discrepancies were also closed out during October.

28

GATV Progress Report, October 1965, p. 2-14.

Gemini launch vehicle (GLV) 7 was erected at complex 19, following the deerection of GLV-6. Power was applied to GLV-7 on October 31, and Subsystems Reverification Tests (SSRT) began immediately. SSRT ended November 9, and the Prespacecraft Mate Verification Test was performed November 10. This test now included dropping all umbilicals, eliminating the need for a Flight Configuration Mode Test (FCMT). No FCMT was performed on GLV-7 or any subsequent vehicle.

29-30

PROJECT GEMINI: A CHRONOLOGY

1965

Mission Report for GT-VII, p. 12-7; Aerospace *Final Report*, pp. II.F-4, II.F-5;
Gemini Midprogram Conference, p. 217.

November
1

The subpanel for Gemini VI of the Agena Flight Safety Review Board met at Lockheed. The subpanel, chaired by Colonel John B. Hudson, Deputy Commander for Launch Vehicles, Air Force Space Systems Division, reviewed Lockheed's flight safety analysis of the failure of Gemini Agena target vehicle (GATV) 5002 on October 25. The subpanel approved the conclusions reached by Lockheed's analysts, that the catastrophic anomaly was apparently caused by a "hard start" of the Agena's main engine, most probably resulting from a fuel rather than oxidizer lead into the thrust chamber before ignition. Unlike all previous standard Agenas, the GATV had been intentionally sequenced for a fuel lead to conserve oxidizer for the many programmed restarts. The subpanel reported its findings to the parent board on November 3.

Quarterly Status Report No. 15, p. 21; Aerospace *Final Report*, p. III.E-1;
GATV Progress Report, November 1965, pp. 2-1, 2-2.

3

Martin-Baltimore received the propellant tanks for Gemini launch vehicle (GLV) 11 from Martin-Denver, which had began fabricating them June 28. They were shipped by rail October 27. The GLV-11 stage II fuel tank was used in GLV-10, and the stage II fuel tank from GLV-12 was reassigned to GLV-11, arriving by air from Martin-Denver January 16, 1966. Aerojet-General delivered the engines for GLV-11 on December 14, 1965. Stage I tank splicing and engine installation was complete by March 31, stage II by April 5. Stage I horizontal tests ended April 12 and stage II, April 25.

Gemini Program Mission Report, Gemini XI, October 1966, p. 12-7; Aerospace *Final Report*, p. II.G-7; *Gemini-Titan II Air Force Launch Vehicle*, p. D-18.

3

The Agena Flight Safety Review Board met at Lockheed to continue its investigation of the failure of Gemini Agena target vehicle 5002 on October 25. The board, chaired by George E. Mueller, NASA Associate Administrator of Manned Space Flight, reviewed the findings of the subpanel for Gemini VI and reached the same conclusion: the failure resulted from a hard start probably caused by the fuel lead. The next day the board presented its recommendation to Air Force Space Systems Division for a contractual change covering a program to modify the design of the Model 8247 main rocket engine to revert to oxidizer lead. Design verification testing would follow. Existing engines would be recycled through Bell Aerosystems to allow the incorporation of the design modifications. Since two existing engines would be used for design verification testing, two new engines were to be procured as replacements.

Quarterly Status Report No. 15, p. 21; *GATV Progress Report*, November 1965, pp. 2-1, 2-2.

8

The Combined Systems Acceptance Test of Gemini launch vehicle (GLV) 8 was conducted at Martin-Baltimore. The vehicle acceptance team convened November 16 and completed its inspection November 19, deeming the vehicle excellent. GLV-8 was decreted December 13-14 and was formally accepted by the Air Force on December 23. Stage I was airlifted to Cape Kennedy on

January 4, 1966, followed by stage II on January 6. Both stages were placed in storage.

1965
November

Mission Report for GT-VIII, pp. 12-6, 12-7; Aerospace *Final Report*, p. II.G-5; *Gemini-Titan II Air Force Launch Vehicle*, p. D-14.

Manned Spacecraft Center announced that Elliot M. See, Jr., had been selected as command pilot and Charles A. Bassett II as pilot for the Gemini IX mission. The backup crew would be Thomas P. Stafford, command pilot, and Eugene A. Cernan, pilot. The mission, scheduled for the third quarter of 1966, would last from two to three days and would include rendezvous and docking and extravehicular activity. Bassett would remain outside the spacecraft for at least one revolution and would wear the manned maneuvering unit backpack, a self-propelled hydrogen-peroxide system with gyro stabilization designed by the Air Force.

8

Astronautics and Aeronautics, 1965, p. 510.

Gemini launch vehicle (GLV) 7 and spacecraft No. 7 were electrically mated at complex 19. An electrical interface jumper cable connected the spacecraft, suspended about six feet above stage II, to the GLV. No Wet Mock Simulated Launch (WMSL) was performed on Gemini VII or any subsequent vehicle. WMSL was replaced by the Simultaneous Launch Demonstration (SLD) and a separate tanking test. For Gemini VII, the SLD was also eliminated because no simultaneous Atlas-Agena launch was planned. The elimination of the erector lowering associated with WMSL made it possible to postpone mechanical mating until later in the test sequence. This had the advantage of allowing access to the spacecraft adapter without demating and remating the spacecraft and launch vehicle, while at the same time permitting integrated testing to continue and shortening the test schedule. The Electrical Interface Integrated Validation and Joint Guidance and Control Test was completed November 13. The Joint Combined Systems Test was run November 15. The only countdown exercise performed for Gemini VII was the GLV tanking test on November 16. The spacecraft Final Systems Test was completed November 20. Spacecraft and launch vehicle were mechanically mated November 22, and the Simulated Flight Test was finished November 27.

11

Mission Report for GT-VII, pp. 12-4, 12-7; Aerospace *Final Report*, pp. II.F-4, II.F-5; *Gemini-Titan II Air Force Launch Vehicle*, p. 4-16; *Gemini Midprogram Conference*, p. 217.

A symposium on hypergolic rocket ignition at altitude was held at Lockheed. Because too little diagnostic information had been obtained from the flight of Gemini Agena target vehicle (GATV) 5002 to determine the exact nature of the probable hard start, it was not certain that the proposed modification—a return to oxidizer lead—would definitely prevent a recurrence of the malfunctions. Sixteen propulsion specialists (brought together from Government, industrial, and university organizations) assembled for the symposium and concentrated on clarifying the hard-start phenomenon, isolating possible hard-start mechanisms of the Agena engine, and determining meaningful supporting test programs. They agreed with earlier conclusions on the probable cause of the failure. Their recommendations, with Lockheed's analysis of the GATV 5002 failure, were

12-13

PROJECT GEMINI: A CHRONOLOGY

1965
November

combined into a proposed GATV engine modification and test program that was presented to Air Force Space Systems Division on November 15.

Quarterly Status Report No. 15, pp. 21-22; *GATV Progress Report*, November 1965, pp. 2-2, 2-3.

- 15 Lockheed presented its proposed Gemini Agena target vehicle (GATV) engine modification and test program to Colonel A. J. Gardner, Gemini Target Vehicle Program Director, Air Force Space Systems Division (SSD). The proposal was immediately turned over to a three-man team comprising B. A. Hohmann (Aerospace), Colonel J. B. Hudson (Deputy Commander for Launch Vehicles, SSD), and L. E. Root (Lockheed) for consideration. On November 18, the group decided on a final version of the proposal that called for: (1) modifying the Agena main engine to provide oxidizer lead during the start sequence, (2) demonstrating sea-level engine flightworthiness in tests at Bell Aerosystems, and (3) conducting an altitude test program at Arnold Engineering Development Center. The final proposal was presented to the GATV Review Board at Manned Spacecraft Center on November 20.

Quarterly Status Report No. 15, pp. 21-22; *GATV Progress Report*, November 1965, pp. 2-3, 2-4.

- 19 Aerojet-General delivered the stage II engine for Gemini launch vehicle (GLV) 10 to Martin-Baltimore. The stage I engine had been delivered August 23. Martin-Baltimore completed splicing stage I January 12, 1966; stage II splicing, using the fuel tank reassigned from GLV-11, was finished February 2. Engine installation was completed February 7, and stage I horizontal tests February 11. Stage II horizontal testing ended March 2.

Mission Report for GT-X, p. 12-7; *Gemini-Titan II Air Force Launch Vehicle*, p. D-16.

- 19 Air Force Space Systems Division (SSD) directed Lockheed to return Gemini Agena target vehicle (GATV) 5001 to Sunnyvale. The GATV was still being stored in Hangar E, Eastern Test Range, minus its main engine which SSD had directed Lockheed to ship to Bell Aerosystems on November 9 for modification. Although SSD and NASA had considered using GATV 5001 as the second flight vehicle, it needed to be refurbished, repaired, and updated—work which could be done only at the Lockheed plant. A dummy engine was installed to simulate weight and center of gravity, and the vehicle left the Cape by commercial van on November 20, arriving at Sunnyvale November 24.

GATV Progress Report, November 1965, p. 2-9.

- 24 Lockheed submitted an engineering change proposal to Air Force Space Systems Division (SSD) for Project Surefire, code name for the Gemini Agena Target Vehicle (GATV) Modification and Test Program designed to correct the malfunction which had caused the failure of GATV 5002 on October 25. SSD gave Lockheed a tentative go-ahead for Project Surefire on November 27 and established an emergency priority for completing the program. On the same day, Lockheed announced the formation of a Project Surefire Engine Development Task Force to carry out the program. Work was geared to meet the scheduled launch of GATV 5003 for Gemini VIII. GATV 5003 systems testing was halted. The main engine was removed November 23 and shipped to

Bell Aerosystems for modification. Work on GATV 5004 was reprogrammed to allow it to complete final assembly with a modified engine.

1965
November

Mission Report for GT-VIII, p. 12-8; Engineering Change Proposal (ECP) LH-545-101P "GATV Modification and Test Program (Project Surefire)," Nov. 24, 1965, as cited in *GATV Progress Report*, November 1965, pp. 2-3, 2-4; *GATV Progress Reports*: November, pp. 2-5, 2-9; December 1965, pp. 2-11, 2-12, 2-13.

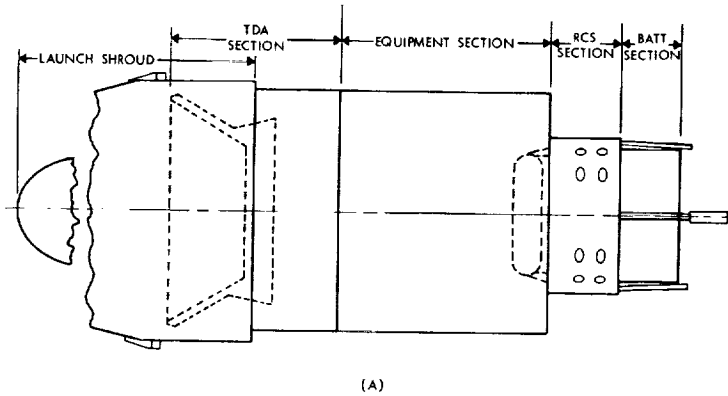
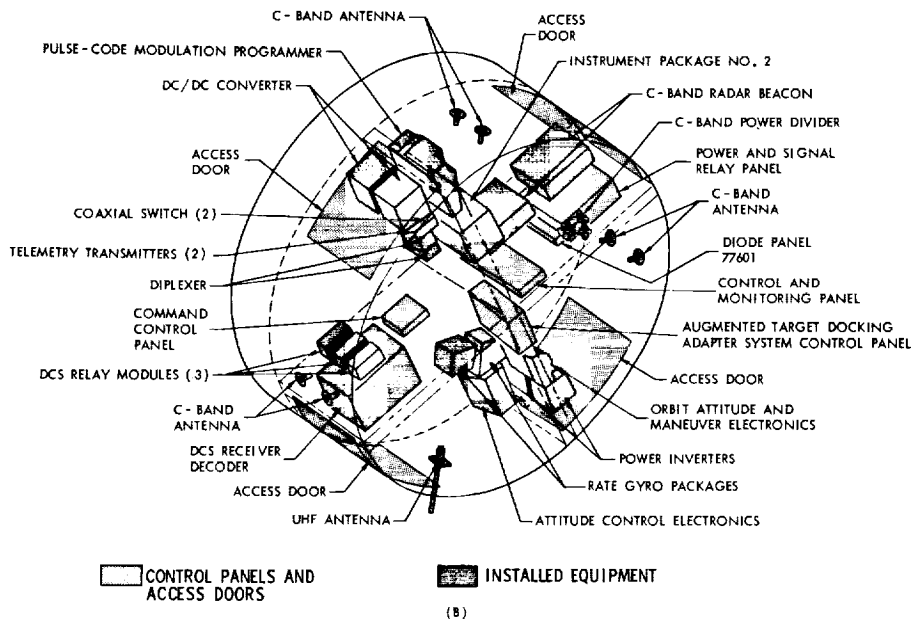

Figure 111.—(A) General arrangement of sections in the augmented target docking adapter; (B) Augmented target docking adapter equipment installation. (McDonnell Report No. F169, Gemini Final Summary Report, Feb. 20, 1967, pp. 556, 544.)



McDonnell proposed building a backup target vehicle for Gemini rendezvous missions. The augmented target docking adapter (ATDA) would serve as an alternative to the Gemini Agena target vehicle (GATV) if efforts to remedy the GATV problem responsible for the October 25 mission abort did not meet the date scheduled for launching Gemini VIII. Using Gemini-qualified equipment, the ATDA (as its name implied) was essentially a target docking adapter

26

1965
November

(TDA) with such additions as were needed to stabilize it and allow the spacecraft to acquire and dock with it. In addition to the shroud and TDA, these included a communications system (comprising tracking, telemetry transmission, and command subsystems), instrumentation, a guidance and control system (made up of a target stabilization system and rendezvous radar transponder), electrical system, and a reaction control system identical to the Gemini spacecraft's. Robert C. Seamans, Jr., NASA Associate Administrator, approved the procurement of the ATDA on December 9, and McDonnell began assembling it December 14.

Mission Report for GT-IXA, pp. 3-43 to 3-47, 12-8; Quarterly Status Report No. 16 for Period Ending Feb. 28, 1966, p. 4; message, Day to Mathews, Dec. 10, 1965; Lindley, "Gemini Engineering Program," p. 18; McDonnell *Final Report*, pp. 570-573.

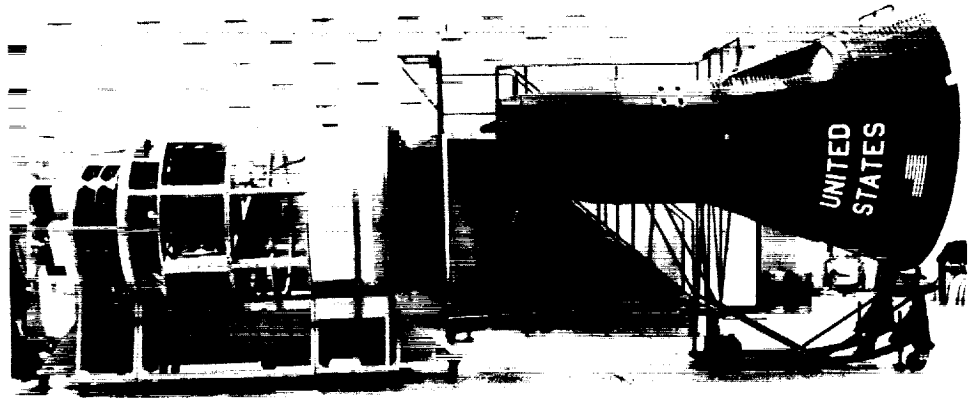

Figure 112.—Mock-up of the augmented target docking adapter at McDonnell, along with a spacecraft mock-up. (NASA Photo S-65-62180, Dec. 12, 1965.)

29

Director Robert R. Gilruth, Manned Spacecraft Center, requested the concurrence of NASA Headquarters in plans for doffing the G5C pressure suits during orbital flight in Gemini VII. Both astronauts wanted to remove their suits after the second sleep period and don them only for transient dynamic conditions, specifically rendezvous and reentry. Primary concern was preventing the degradation of crew performance by maintaining crew comfort during the long-duration mission. Gemini Program Office had participated in the G5C suit program and certified the suit for intravehicular manned flight in the Gemini spacecraft on November 19. When Gemini VII was launched on December 4, the mission plan required one astronaut to be suited at all times, but on December 12 NASA Headquarters authorized both crew members to have their suits off at the same time.

Memos, Mathews to Mueller, Subj: Lightweight suit evaluation, Nov. 19, 1965, with enc., Design Certification Report on the Lightweight Space Suit, G-5C for Gemini VII Mission, Nov. 19, 1965; Gilruth to Mueller, Subj: Use of G-5C suits on Gemini VII, Nov. 29, 1965; Mueller to Gilruth, Subj: G-5C Operational Test Procedure, Dec. 12, 1965.

December
3

McDonnell began altitude chamber and extravehicular support package tests of spacecraft No. 8. These tests were completed December 13. During the re-

mainder of the month, the spacecraft was updated and retested before being shipped to Cape Kennedy on January 8, 1966.

December
1965

Mission Report for GT-VIII, p. 12-2.

Figure 113.—Astronauts Frank Borman and James A. Lovell, Jr., walking up the ramp to the elevator at pad 19 prior to their Gemini VII flight. They are wearing the new lightweight G5C suits. (NASA Photo S-65-44290, Dec. 4, 1965.)

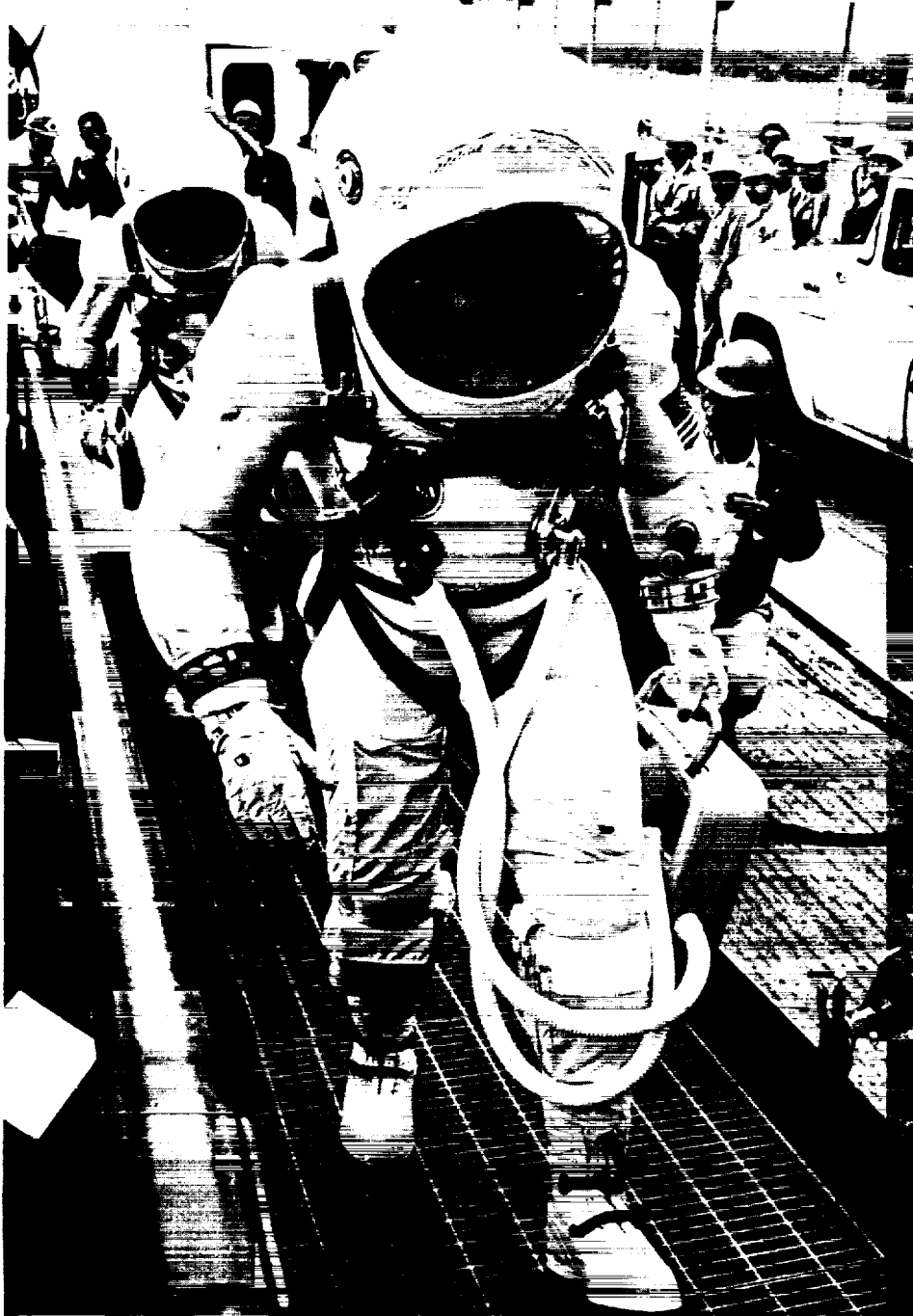

1965
December
4

Gemini VII, the fourth manned mission of the Gemini program, was launched from complex 19 at 2:30 p.m., e.s.t. Primary objectives of the mission, flown by command pilot Astronaut Frank Borman and pilot Astronaut James A. Lovell, Jr., were demonstrating manned orbital flight for approximately 14 days and evaluating the physiological effects of a long-duration flight on the crew. Among the secondary objectives were providing a rendezvous target for the Gemini VI-A spacecraft, stationkeeping with the second stage of the launch vehicle and with spacecraft No. 6, conducting 20 experiments, using lightweight pressure suits, and evaluating the spacecraft reentry guidance capability. All objectives were successfully achieved with the exception of two experiments lost because of equipment failure. Shortly after separation from the launch vehicle, the crew maneuvered the spacecraft to within 60 feet of the second stage and stationkept for about 15 minutes. The exercise was terminated by a separation maneuver, and the spacecraft was powered down in preparation for the 14-day mission. The crew performed five maneuvers during the course of the mission to increase orbital lifetime and place the spacecraft in proper orbit for rendezvous with spacecraft No. 6. Rendezvous was successfully accomplished during the 11th day in orbit, with spacecraft No. 7 serving as a passive target for spacecraft No. 6. About 45 hours into the mission, Lovell removed his pressure suit. He again donned his suit at 148 hours, while Borman removed his. Some 20 hours later Lovell again removed his suit, and both crewmen flew the remainder of the mission without suits, except for the rendezvous and reentry phases. With three exceptions, the spacecraft and its systems performed nominally throughout the entire mission. The delayed-time telemetry playback tape re-

Figure 114.—Astronauts Borman (right) and Lovell on the deck of the U.S.S. Wasp after completing their 14-day mission. (NASA Photo No. 65-H-2323, released Dec. 18, 1965.)





Figure 115.—Gemini spacecraft No. 6, after removal from storage, being hoisted to the top of the launch pad at complex 19. (NASA Photo No. 65-H-1906, released Dec. 5, 1965.)

1965
December

order malfunctioned about 201 hours after liftoff, resulting in the loss of all delayed-time telemetry data for the remainder of the mission. Two fuel cell stacks showed excessive degradation late in the flight and were taken off the line; the remaining four stacks furnished adequate electrical power until reentry. Two attitude thrusters performed poorly after 283 hours in the mission. Retrofire occurred exactly on time, and reentry and landing were nominal. The spacecraft missed the planned landing point by only 6.4 miles, touching down at 9:05 a.m., December 18. The crew arrived at the prime recovery ship, the aircraft carrier *Wasp*, half an hour later. The spacecraft was recovered half an hour after the crew.

Mission Report for GT-VII, pp. 1-1, 1-2, 1-3, 2-1, 2-2, 6-18; Fact Sheet 291-D; McDonnell *Final Report*, pp. 71-73.

- 4 Both stages of Gemini launch vehicle (GLV) 6 were removed from storage and arrived at complex 19 two hours after the launch of *Gemini VII*. Spacecraft No. 6 was returned to complex 19 on December 5. Within 24 hours after the launch of *Gemini VII*, both stages of GLV-6 were erected, spacecraft and launch vehicle were mated, and power was applied. Subsystems Reverification Tests were completed December 8. The only major problem was a malfunction of the spacecraft computer memory. The computer was replaced and checked out December 7-8. The Simulated Flight Test, December 8-9, completed pre-launch tests. The launch, initially scheduled for December 13, was rescheduled for December 12.

Mission Report for GT-VIA, pp. 12-5, 12-9; Kuras and Albert, "Gemini-Titan Technical Summary," pp. 144-145; *Gemini-Titan II Air Force Launch Vehicle*, p. D-12.

- 8-10 Gemini launch vehicle 9 was erected in the east cell of the vertical test facility at Martin-Baltimore. Power was applied to the launch vehicle for the first time on December 22, and Subsystems Functional Verification Tests were completed January 20, 1966.

Mission Report for GT-IXA, p. 12-6; *Gemini-Titan II Air Force Launch Vehicle*, p. D-15.

- 12 The scheduled launch of Gemini VI-A was aborted when the Master Operations Control Set automatically shut down the Gemini launch vehicle a second after engine ignition because an electrical umbilical connector separated prematurely. The launch was canceled at 9:54 a.m., e.s.t. Emergency procedures delayed raising the erector until 11:28, so the crew was not removed until 11:33 a.m. Launch was rescheduled for December 15. Routine analysis of engine data, begun immediately after shutdown, revealed decaying thrust in one first stage engine subassembly before shutdown had been commanded. The problem was diagnosed as a restriction in the gas generator circuit of the subassembly, which would have caused shutdown about 1 second later than it actually occurred as a result of the umbilical disconnect. Source of the restriction proved to be a protective dust cap inadvertently left in place in the gas generator oxidizer injector inlet port. The anomalies were corrected and recycling, based on long-prepared contingency plans, proceeded without incident through launch on December 15.

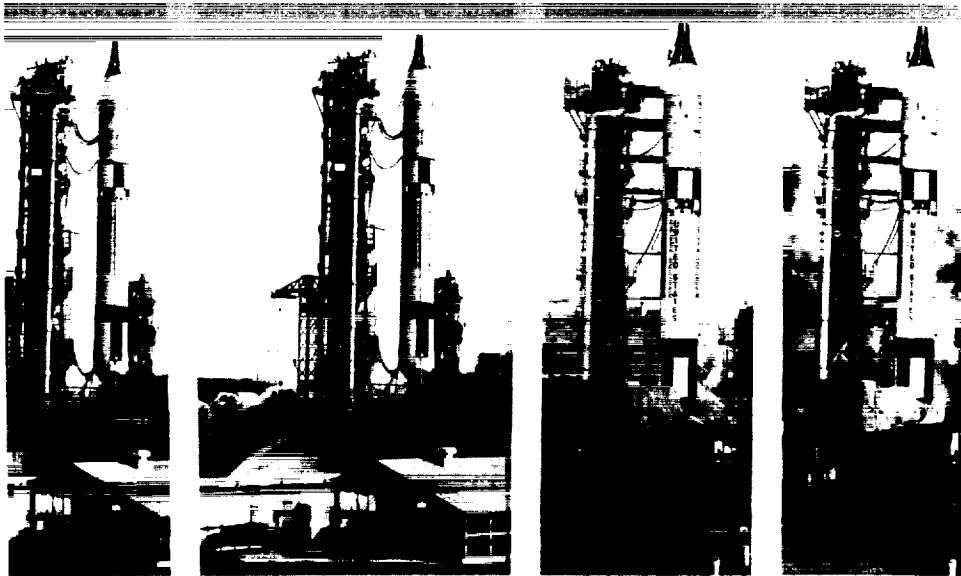

Figure 116.—Attempted launch and the shutdown of Gemini VI-A. (NASA Photo No. 65-H-1944, released Dec. 12, 1965.)

Mission Report, GT-VIA, pp. 5-77, 5-79, 5-80, 5-91, 5-92; Aerospace Final Report, p. II.E-19; Kuras and Albert, "Gemini-Titan Technical Summary," p. 145.

1965
December

Air Force Space Systems Division authorized Lockheed to begin the disassembly and inspection of Gemini Agena target vehicle 5001 to determine the extent of refurbishment needed. The vehicle was stripped down to its major structural components to expose all areas of possible contamination.

14

GATV Progress Report, December 1965, pp. 2-4, 3-1.

Gemini VI-A, the fifth manned and first rendezvous mission in the Gemini program, was launched from complex 19 at 8:37 a.m., e.s.t. The primary objective of the mission, crewed by command pilot Astronaut Walter M. Schirra, Jr., and pilot Astronaut Thomas P. Stafford, was to rendezvous with spacecraft No. 7. Among the secondary objectives were stationkeeping with spacecraft No. 7, evaluating spacecraft reentry guidance capability, testing the visibility of spacecraft No. 7 as a rendezvous target, and conducting three experiments. After the launch vehicle inserted the spacecraft into an 87- by 140-nautical-mile orbit, the crew prepared for the maneuvers necessary to achieve rendezvous. Four maneuvers preceded the first radar contact between the two spacecraft. The first maneuver, a height adjustment, came an hour and a half after insertion, at first perigee; a phase adjustment at second apogee, a plane change, and another height adjustment at second perigee followed. The onboard radar was turned on 3 hours into the mission. The first radar lock-on indicated 246 miles between the two spacecraft. The coelliptic maneuver was performed at third apogee, 3 hours 47 minutes after launch. The terminal phase initiation maneuver was performed an hour and a half later. Two midcourse corrections preceded final braking maneuvers at 5 hours 50 minutes into the flight. Rendezvous was technically accomplished and stationkeeping began some 6 minutes later when the

15

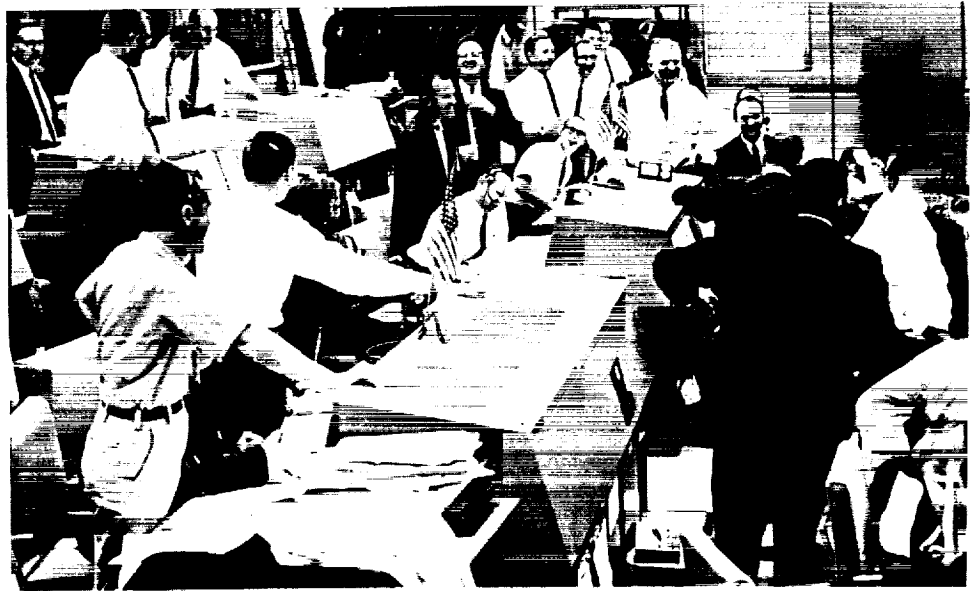

Figure 117.—The Mission Control Center at Houston just after the announcement from the orbiting spacecraft that Gemini VI-A and VII had achieved rendezvous. (NASA Photo No. S-65-62720, Dec. 15, 1965.)

Figure 118.—U.S. Navy swimmers attaching the cable to the Gemini VI-A spacecraft, containing the astronauts, to haul it aboard the U.S.S. Wasp. The crew remained in the spacecraft during recovery. (NASA Photo No. 65-H-2294, released Dec. 16, 1965.)



two spacecraft were about 120 feet apart and their relative motion had stopped. Stationkeeping maneuvers continued for three and a half orbits at distances from 1 to 300 feet. Spacecraft No. 6 then initiated a separation maneuver and withdrew to a range of about 30 miles. The only major malfunction in spacecraft No. 6 during the mission was the failure of the delayed-time telemetry tape recorder at 20 hours 55 minutes ground elapsed time, which resulted in the loss of all delayed-time telemetry data for the remainder of the mission, some 4 hours and 20 minutes. The flight ended with a nominal reentry and landing in the West Atlantic, just 7 miles from the planned landing point, at 10:29 a.m., December 16. The crew remained in the spacecraft, which was recovered an hour later by the prime recovery ship, the aircraft carrier *Wasp*.

1965
December

Mission Report for GT-VIA, pp. 1-1, 1-2, 2-1, 4-1, 4-2, 4-3; Fact Sheet 291-D; McDonnell *Final Report*, pp. 70-71.

The Air Force accepted the main rocket engine for Gemini Agena target vehicle (GATV) 5003 after Bell Aerosystems had completed Project Surefire modifications. The engine was shipped immediately and arrived at Lockheed December 18. Lockheed completed reinstalling the engine on December 20. GATV 5003 systems retesting began December 27 after other equipment modifications had been installed.

17

Mission Report for GT-VIII, p. 12-8; *GATV Progress Report*, December 1965, pp. 2-1, 2-3, 2-4, 2-6, 3-4.

The acceptance meeting for Atlas 5303, target launch vehicle for Gemini IX, was held at San Diego. An unresolved problem with a liquid oxygen tank pressurization duct delayed formal acceptance until investigation revealed that the ducts were satisfactory. The vehicle left San Diego by truck on February 4 and arrived at Cape Kennedy February 13, 1966.

27

Quarterly Status Report No. 16, p. 19.

Atlas 5302, target launch vehicle for Gemini VIII, was erected at complex 14. Air Force Space Systems Division and General Dynamics/Convair had begun intensive efforts to ensure the vehicle's flight readiness immediately after the Agena failure on October 25, 1965. The effort resulted in procedural and design changes intended to improve vehicle reliability. Of the 20 engineering change proposal differences between Atlas 5301 (launched October 25) and Atlas 5302, all but one were proven in other Atlas flights before Atlas 5302 was launched. The exception was a new destruct unit which flew for the first time in Atlas 5302. Booster subsystems tests continued until February 23.

1966
January
5

Mission Report for GT-VIII, p. 12-13; Quarterly Status Report No. 16, p. 18.

McDonnell delivered spacecraft No. 8 to Cape Kennedy. Fuel cell installation, heater resistance checks, and pyrotechnics buildup lasted two weeks. The spacecraft was then transferred to Merritt Island Launch Area for integrated (Plan X) test with the target vehicle, January 26-28, and extravehicular equipment compatibility test, January 29.

8

Mission Report for GT-VIII, p. 12-4.

1966
January
8

Gemini Agena target vehicle (GATV) 5003 completed its final acceptance tests at Sunnyvale, after an elusive command system problem had made it necessary to rerun the final systems test (January 4). No vehicle discrepancy marred the rerun. Air Force Space Systems Division formally accepted GATV 5003 on January 18, after the vehicle acceptance team inspection. It was shipped to Eastern Test Range the same day, but bad weather delayed delivery until January 21. GATV 5003 was to be the target vehicle for Gemini VIII.

GATV Progress Report, January 1966, pp. 2-2, 2-4.

13

Gemini launch vehicle (GLV) 8 was erected at complex 19. After the vehicle was inspected and umbilicals connected, power was applied January 19. Subsystems Reverification Tests began the following day and lasted until January 31. The Prespacecraft Mate Verification of GLV-8 was run February 1. A launch test-procedure review was held February 2-3. During leak checks of the stage II engine on February 7, small cracks were found in the thrust chamber manifold. X-rays revealed the cracks to be confined to the weld; rewelding eliminated the problem. Systems rework and validation were completed February 9.

Mission Report for GT-VIII, p. 12-7; Aerospace *Final Report*, p. II.G-5; Kuras and Albert, "Gemini-Titan Technical Summary," p. 146.

16

Project Surefire verification testing began at Bell Aerosystems. Bell's part in the test program was to demonstrate the sea-level flightworthiness of the modified Agena main engine. Bell completed testing on March 4 with a full 180-second mission simulation firing. The successful completion of this phase of the test program gave the green light for the launch of Gemini Agena target vehicle 5003, scheduled for March 15.

GATV Progress Reports: January, pp. 2-1, 2-2; March 1966, pp. 2-3, 2-4.

17

At a NASA-McDonnell Management Panel meeting, W. B. Evans of Gemini Program Office reviewed possible future mission activities. Gemini VIII would have three periods of extravehicular activity (EVA)—two in daylight, one in darkness—and would undock during EVA with the right hatch snubbed against the umbilical guide and the astronaut strapped into the adapter section. A redocking would be performed with one orbit of stationkeeping performed before each docking. EVA would include retrieval of the emulsion pack from the adapter, the starting of the S-10 (Micrometeorite Collection) experiment on the Agena, and the use of a power tool. The astronaut would don the extravehicular support pack, use the hand-held maneuvering unit, and check different lengths of tether. The spacecraft would maneuver to the astronaut and the astronaut to the Agena. It would incorporate a secondary propulsion system burn with the Agena and would be a three-day mission. Gemini IX would also be a three-day mission and would include a simulated lunar module (LM) rendezvous (third apogee rendezvous), a primary propulsion system (PPS) burn with the docked Agena, a rendezvous from above, a simulated LM abort, a phantom rendezvous with three PPS burns (double rendezvous), EVA with the modular maneuvering unit, and the parking of the Gemini VIII and Gemini IX Agenas. Gemini X would include a dual rendezvous with a parked

Agena and the retrieval of the S-10 experiment after undocking with the new Agena, using EVA.

1966
January

Minutes of NASA-MAC Management Panel Meeting held at MSC, Jan. 17, 1966.

Martin-Denver delivered propellant tanks for Gemini launch vehicle (GLV) 12 to Martin-Baltimore by air. The GLV-12 stage II fuel tank had been re-allocated to GLV-11, and GLV-12 used the stage II fuel tank originally assigned to GLV-10, which had been reworked to eliminate the damaged dome that had caused the tank reshuffling. The reworked tank arrived March 12. Aerojet-General had delivered the stage I engine on December 13, 1965, the stage II engine on January 20. Stage I tank splice was completed April 25, stage II on May 4. Engine installations were completed May 19. Stage I horizontal testing ended June 1, and stage II, June 22.

20

Gemini Program Mission Report, Gemini XII, January 1967, p. 12-7; Aerospace Final Report, p. II.G-7; Gemini-Titan II Air Force Launch Vehicle, pp. D-19, D-20.

McDonnell completed final assembly of the augmented target docking adapter (ATDA). Voltage Standing Wave Ratio Tests were conducted January 21 and 22. Systems Assurance Tests were completed January 25, vibration tests January 27. Simulated flight and phasing tests were conducted January 30-February 1. The ATDA was shipped to Cape Kennedy February 4.

21

Mission Report for GT-IXA, p. 12-8.

Qualification testing of the freon-14 extravehicular propulsion system for the Gemini VIII mission had been successfully completed. During earlier tests some freezing problems had resulted; however, with particular attention given to drying procedures used in loading the gas, the freezing problem was eliminated, and later tests were successful. Oxygen had been used for propulsion fuel during extravehicular activities by Astronaut Edward H. White II on Gemini IV.

21

Quarterly Activity Report, Jan. 31, 1966, p. 44.

Gemini Agena target vehicle (GATV) 5003 was mated to target docking adapter (TDA) 3. McDonnell had delivered TDA-3 to Cape Kennedy on January 8. The GATV/TDA interface functional test was completed January 24, and the vehicle was transferred to Merritt Island Launch Area for integrated tests with spacecraft No. 8 and extravehicular equipment, which were completed January 28.

22

Mission Report for GT-VIII, p. 12-10; GATV Progress Report, January 1966, p. 2-5.

Astronaut John W. Young had been selected as the command pilot for Gemini X. The pilot would be Astronaut Michael Collins. The backup crew would be James A. Lovell, Jr., command pilot, and Edwin E. Aldrin, Jr., pilot.

25

Astronautics and Aeronautics, 1966: Chronology of Science, Technology, and Policy, NASA SP-4007, p. 27; MSC Space News Roundup, Feb. 4, 1966, p. 2.

Gemini Agena target vehicle (GATV) 5004 was transferred to the vehicle systems test area at Sunnyvale. Its modified main engine had been received

26

PROJECT GEMINI: A CHRONOLOGY

1966
January

on schedule from Bell Aerosystems January 12 and installed by January 20. Because of GATV 5003 priority, however, several main electronic assemblies, including the command system, had been removed from GATV 5004 and used in GATV 5003 final acceptance tests. As a result, GATV 5004 had fallen eight days behind its scheduled transfer date, January 18.

GATV Progress Report, January 1966, pp. 2-5, 2-6.

28

Gemini Agena target vehicle (GATV) 5003 was returned to Hangar E after completing Plan X tests at Merritt Island Launch Area. Systems Verification and Combined Interface Tests were conducted through February 18, followed by functional checks of the primary and secondary propulsion systems. Hangar E testing ended February 28, and the GATV was transferred to complex 14.

Mission Report for GT-VIII, p. 12-10; GATV Progress Report, January 1966, p. 2-5.

31

Gemini spacecraft No. 8 was transferred to complex 19 and hoisted to its position atop the launch vehicle. Cables were connected for test February 1-2, and Prespacecraft Mate Verification Tests were conducted February 3-8. Fuel cells were activated February 8 and deactivated the following day. Spacecraft/launch vehicle integrated tests began February 10.

Mission Report for GT-VIII, p. 12-4.

February
2

A mission planning meeting for Gemini flights IX through XII, held at McDonnell, was attended by members of the Gemini Program Office and Flight Operations Division. The last item on the agenda was a reminder from McDonnell that the Gemini spacecraft was capable of flying to a relatively high elliptic orbit from which it could safely reenter under certain circumstances. The type of orbit McDonnell suggested had an apogee of 500-700 nautical miles. This would involve using the Agena primary propulsion system both to get into this orbit and to return to a 161-mile circular orbit for nominal reentry.

Memo, Asst. Chief, MPAD, to Distribution, Subj: Mission Planning Meeting at MAC, Feb. 8, 1966.

2

Agena D (AD-129) was accepted by the Air Force for delivery to the Gemini program. It was transferred to the final assembly area at Sunnyvale for modification to Gemini Agena target vehicle 5005.

Aerospace Final Report, p. III.G-3.

4

The augmented target docking adapter (ATDA) arrived at Cape Kennedy. Modifications, testing, and troubleshooting were completed March 4. The ATDA, which was intended to back up the Gemini Agena target vehicle (GATV), was then placed in storage (March 8) where it remained until May 17, when the failure of target launch vehicle 5303 prevented GATV 5004 from achieving orbit. The ATDA became the target for Gemini IX-A.

Mission Report for GT-IXA, p. 12-9; Quarterly Status Report No. 17 for Period Ending May 31, 1966, p. 2.

9

The Combined Systems Acceptance Test of Gemini launch vehicle (GLV) 9 was successfully conducted in the vertical test facility at Martin-Baltimore. The

vehicle acceptance team convened February 14 and concluded its review on February 17 by accepting the vehicle. Deerection of GLV-9 was completed February 25, and the vehicle was formally accepted by the Air Force March 8. Stage I arrived at Cape Kennedy on March 9, stage II on March 10.

1966
February

Mission Report for GT-IXA, pp. 12-6, 12-7; Aerospace Final Report, p. II.G-7; Gemini-Titan II Air Force Launch Vehicle, p. D-15.

Gemini launch vehicle 8 and spacecraft 8 were electrically mated; the Electrical Interface Integrated Validation and Joint Guidance and Control Test was completed February 14. After data from this test were reviewed (February 15), the Joint Combined Systems Test was run February 16.

10

Mission Report for GT-VIII, p. 12-7.

The tanking test of Gemini launch vehicle (GLV) 8 was conducted. While the launch vehicle was being cleaned up after the test, spacecraft No. 8 Final Systems Test was completed February 23. On February 25, GLV and spacecraft were temporarily mated for an erector-cycling test. The extravehicular support package and life support system were checked out and installed in the spacecraft between February 26 and March 5, while GLV systems were modified and revalidated February 28 to March 3.

17

Mission Report for GT-VIII, pp. 12-4, 12-7; Aerospace Final Report, p. II.G-5.

A successful Booster Flight Acceptance Composite Test (B-FACT) completed subsystems testing of target launch vehicle 5302. Component problems had delayed completion of some of the vehicle pad tests, including B-FACT, which had first been run on February 4. Difficulties were also encountered in completing the propellant tanking tests.

23

Mission Report for GT-VIII, p. 12-13; Quarterly Status Report No. 16, p. 18.

The astronaut maneuvering unit (AMU) scheduled to be tested on the Gemini IX mission was delivered to Cape Kennedy. The receiving inspection revealed nitrogen leaks in the propulsion system and oxygen leaks in the oxygen supply system. Reworking these systems to eliminate the leakage was completed on March 11. Following systems tests, the AMU was installed in spacecraft No. 9 (March 14-18).

23

Mission Report for GT-IXA, p. 12-12.

Over 600 representatives of Government agencies and industrial firms participating in Project Gemini attended a Gemini Midprogram Conference at Manned Spacecraft Center. They heard some 44 papers describing the development of spacecraft and launch vehicle, flight operations, and the results of the first seven Gemini missions, including the findings of experiments performed during these missions.

23-24

Gemini Midprogram Conference, *passim*.

Gemini Agena target vehicle (GATV) 5004 completed systems testing at Sunnyvale. It was formally accepted by the Air Force on March 11, following the vehicle acceptance team inspection. The next day (March 12), GATV 5004 was shipped by air to Eastern Test Range, arriving March 14.

27

Aerospace Final Report, p. III.G-3; GATV Progress Report, March 1966, pp. 2-5, 2-6.

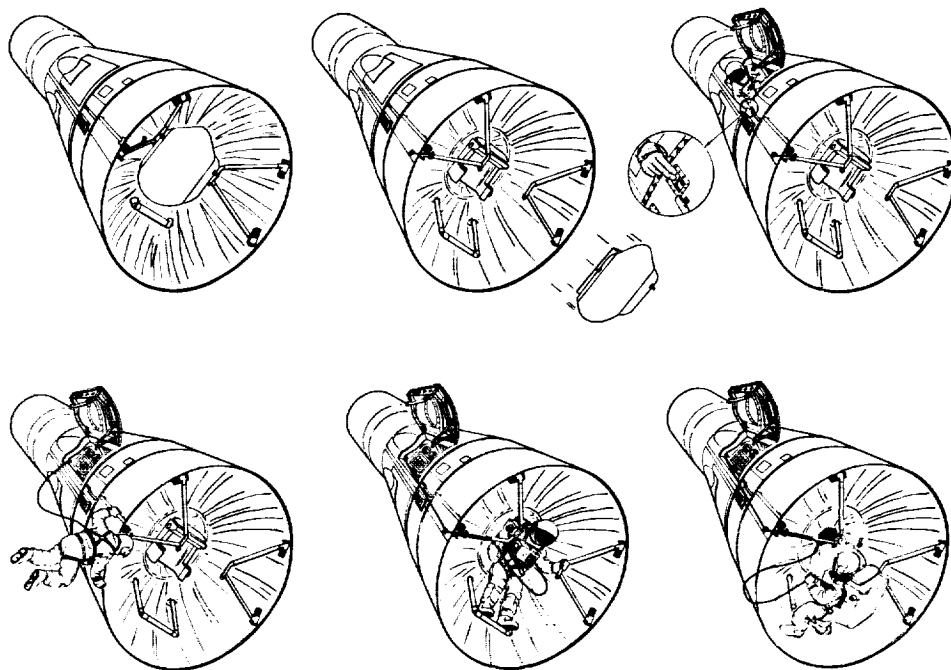

Figure 119.—Method of donning the astronaut maneuvering unit, carried in the adapter section. (NASA Photo S-66-24197, Mar. 16, 1966.)

1966
February
28

Gemini IX Astronauts Elliot M. See, Jr., and Charles A. Bassett II were killed when their T-38 jet training plane crashed in rain and fog short of the St. Louis Municipal Airport. The jet, which had been cleared for an instrument landing, was left of center in its approach to the runway when it turned toward the McDonnell complex, 1000 feet from the landing strip. It hit the roof of the building where spacecraft nos. 9 and 10 were being housed, bounced into an adjacent courtyard, and exploded. Several McDonnell employees were slightly injured. Minutes later the Gemini IX backup crew, Thomas P. Stafford and Eugene A. Cernan, landed safely. The four astronauts were en route to McDonnell for two weeks' training in the simulator. NASA Headquarters announced that Stafford and Cernan would fly the Gemini IX mission on schedule and appointed Alan B. Shepard, Jr., to head a seven-man investigating team.

MSC *Space News Roundup*, Mar. 4, 1966, p. 1; *Washington Post*, Mar. 1 and 2, 1966; interview, John H. Bickers, St. Louis, Apr. 13, 1966.

28

Stage I of Gemini launch vehicle 10 was erected in the east cell of the vertical test facility at Martin-Baltimore. After completing horizontal testing March 3, stage II was erected March 7. Power was applied to the vehicle for the first time on March 14. Subsystems Functional Verification Tests were completed April 13.

Mission Report for GT-X, p. 12-7; *Gemini-Titan II Air Force Launch Vehicle*, pp. D-16, D-17.

March
1

Gemini Agena target vehicle 5003 was mated to target launch vehicle 5302 at complex 14. After ground equipment compatibility tests, the Joint Flight

Acceptance Composite Test was successfully performed on March 7. Simultaneous Launch Demonstration March 8-9 completed Gemini Atlas-Agena target vehicle systems testing in preparation for launch on March 15 as part of the Gemini VIII mission.

1966
March

Mission Report for GT-VIII, p. 12-10; *GATV Progress Report*, March 1966, p. 2-4.

Spacecraft No. 9 and target docking adapter No. 5 arrived at Cape Kennedy from McDonnell. Spacecraft fuel cells were installed March 3-4. Pyrotechnics buildup, further installations, and preparations for test lasted until March 18. The spacecraft was then transferred to Merritt Island Launch Area for Plan X integrated tests with the target vehicle and extravehicular systems March 22-24.

2

Mission Report for GT-IXA, p. 12-4.

Gemini launch vehicle 8 and spacecraft No. 8 were mated for flight at complex 19. The Simultaneous Launch Demonstration with the Gemini Atlas-Agena target vehicle on complex 14 was completed March 9. The Final Simulated Flight Test concluded prelaunch tests on March 10.

6

Mission Report for GT-VIII, p. 12-7.

The fuel tank of target launch vehicle 5302 was overfilled during propellant loading. The necessary replacement of the fuel-tank regulator and fuel relief valve was completed the next day. The launch, which had been scheduled for March 15, was postponed to March 16.

13

Mission Report for GT-VIII, p. 12-13; Kuras and Albert, "Gemini-Titan Technical Summary," p. 147.

The *Gemini VIII* mission began with the launch of the Gemini Atlas-Agena target vehicle from complex 14 at 9:00 a.m., e.s.t. The Gemini space vehicle, with command pilot Astronaut Neil A. Armstrong and pilot Astronaut David R. Scott, was launched from complex 19 at 10:41 a.m. Primary objectives of the scheduled three-day mission were to rendezvous and dock with the Gemini Agena target vehicle (GATV) and to conduct extravehicular activities. Secondary objectives included rendezvous and docking during the fourth revolution, performing docked maneuvers using the GATV primary propulsion system, executing 10 experiments, conducting docking practice, performing a rerendezvous, evaluating the auxiliary tape memory unit, demonstrating controlled reentry, and parking the GATV in a 220-nautical-mile circular orbit. The GATV was inserted into a nominal 161-nautical-mile circular orbit, the spacecraft into a nominal 86- by 147-nautical-mile elliptical orbit. During the six hours following insertion, the spacecraft completed nine maneuvers to rendezvous with the GATV. Rendezvous phase ended at 5 hours 58 minutes ground elapsed time, with the spacecraft 150 feet from the GATV and no relative motion between the two vehicles. Stationkeeping maneuvers preceded docking, which was accomplished at 6 hours 33 minutes ground elapsed time. A major problem developed 27 minutes after docking, when a spacecraft orbit attitude and maneuver system (OAMS) thruster malfunctioned. The crew undocked from the GATV and managed to bring the spacecraft under control by deactivating the OAMS and using the reentry control system (RCS) to reduce the spacecraft's rapid rotation. Premature use of the RCS, however, required

16

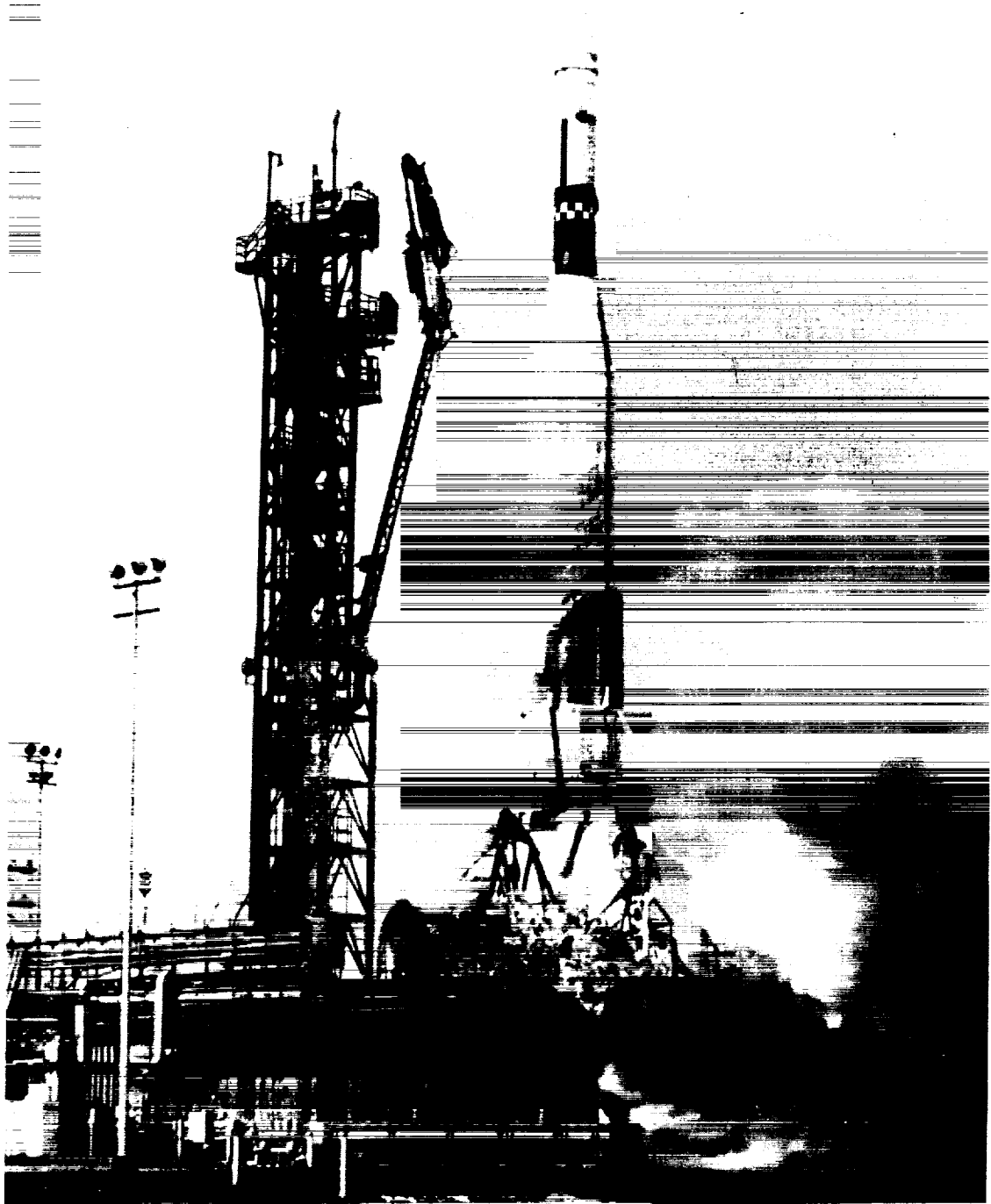
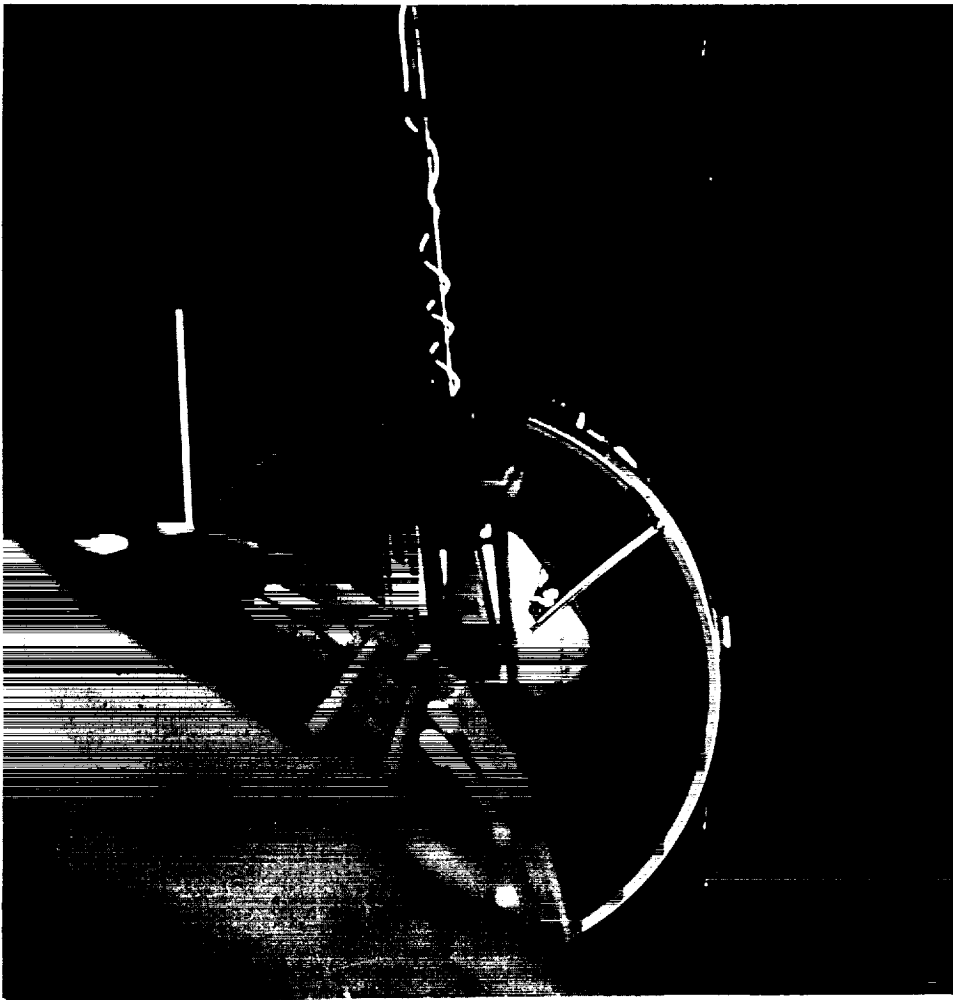

Figure 120.—The launch of the Gemini Atlas-Agena target vehicle for the Gemini VIII mission from complex 14. (NASA Photo No. 66-H-296, released Mar. 16, 1966.)

1966
March

the mission to be terminated early. The retrofire sequence was initiated in the seventh revolution, followed by nominal reentry and landing in a secondary recovery area in the western Pacific Ocean. The spacecraft touched down less



(A)

Figure 121(A).—The Gemini VIII spacecraft approaching the Gemini Agena target vehicle in the final stage of rendezvous (the distance between the two craft is approximately two feet). (NASA Photo No. 66-H-225 [66-HC-191], released Mar. 16, 1966.)

than seven miles from the planned landing point at 10:22 p.m. The recovery ship, the destroyer *Leonard Mason*, picked up both crew and spacecraft some three hours later. Early termination of the mission precluded achieving all mission objectives, but one primary objective—rendezvous and docking—was accomplished. Several secondary objectives were also achieved: rendezvous and docking during the fourth revolution, evaluating the auxiliary tape memory unit, demonstrating controlled reentry, and parking the GATV. Two experiments were partially performed.

Mission Report for GT-VIII, pp. 1-1 to 1-4, 2-1, 2-2, 4-1 to 4-5; Fact Sheet 291-E, *Gemini VIII, Rendezvous and Docking Mission*, April 1966; McDonnell *Final Report*, pp. 73-75.

1966
March



(B)

Figure 121 (B).—The docked Gemini and Agena. (NASA Photo No. 66-H-226 [66-HC-192], released Mar. 16, 1966.)

1966
March
16

Following the early termination of *Gemini VIII*, Gemini Agena target vehicle (GATV) 5003 remained in orbit, where its various systems were extensively exercised. The main engine was fired nine times, four more than required by contract, and 5000 commands were received and executed by the command and communications system, as against a contractual requirement of 1000. GATV 5003 electrical power was exhausted during the 10th day of orbit and the vehicle could no longer be controlled. Before that, however, all attitude control gas was vented overboard to preclude errant thruster malfunction, and the

vehicle was placed into a 220-nautical-mile circular decay orbit, one of the secondary objectives of the *Gemini VIII* mission. This would put GATV 5003 low enough during the Gemini X mission to be inspected by the astronauts.

1966
March

MSC Minutes of Senior Staff Meeting, Mar. 18, 1966, p. 2; Mission Report for GT-VIII, pp. 1-3, 1-4, 2-2; *GATV Progress Reports: March*, pp. 2-1, 2-2; April 1966, pp. 2-7, 2-8, 2-9.

The extravehicular life support system (ELSS) for Gemini spacecraft No. 9 was delivered to Cape Kennedy. Compatibility tests involving the ELSS, the astronaut maneuvering unit, and the spacecraft were completed March 24. The ELSS was returned to the contractor on April 6 for modification.

17

Mission Report for GT-IXA, p. 12-12.

NASA announced the astronaut assignments for Gemini XI. The prime crew would be command pilot Charles Conrad, Jr., and pilot Richard F. Gordon, Jr.; backup crew would be Neil A. Armstrong, command pilot, and William A. Anders, pilot. James A. Lovell, Jr., and Edwin E. Aldrin, Jr., backup crew for the Gemini X mission, were reassigned as backup crew for Gemini IX. Alan L. Bean and Clifton C. Williams, Jr., were named the new backup crew for Gemini X.

19

MSC News Release 66-20, Mar. 21, 1966.

Gemini Agena target vehicle 5004 and spacecraft No. 9 began Plan X compatibility tests at Merritt Island Launch Area Radar Range.

21

GATV Progress Report, March 1966, p. 2-6.

Agena D (AD-130) was formally accepted by the Air Force for the Gemini program and moved to Building 104 at Sunnyvale for modification and final assembly as Gemini Agena target vehicle 5006.

22

GATV Progress Report, March 1966, p. 2-10.

Gemini launch vehicle 9 was removed from storage and erected at complex 19. The vehicle was inspected and umbilicals connected by March 28. Power was applied March 29, and the Subsystems Reverification Test (SSRT) began March 30. SSRT concluded April 11. The Prespacecraft Mate Verification Combined Systems Test was completed April 12.

24

Mission Report for GT-IXA, p. 12-7.

Air Force Space Systems Division and Lockheed agreed not to curtail the Project Surefire test program despite the excellent performance of Gemini Agena target vehicle (GATV) 5003 during the *Gemini VIII* mission. The final test phase of Project Surefire began March 28 with two firings at Arnold Engineering Development Center. This phase of testing included low temperature starts and planned malfunctions. Testing culminated on April 4 with a planned fuel lead test. As predicted, an engine hard start occurred. Data from analysis of engine damage correlated well with data from the GATV 5002 failure, tending to confirm the hypothesis that failure resulted from a hard start caused by fuel preceding oxidizer into the thrust chamber during ignition.

24

MSC Minutes of Senior Staff Meeting, Apr. 8, 1966, p. 4; Quarterly Status Report No. 17, pp. 18-19; *GATV Progress Reports: March*, p. 2-3; April 1966, pp. 2-9, 2-10.

PROJECT GEMINI: A CHRONOLOGY

1966
March
28

Gemini spacecraft No. 9 was transferred to complex 19 and hoisted to its position atop the launch vehicle. During the next two days the spacecraft was cabled for testing, and premate verification began March 31, ending April 6. After activation and deactivation of the fuel cells, preparations for spacecraft/launch vehicle integrated tests began April 11.

Mission Report for GT-IXA, p. 12-4.

31

Atlas target launch vehicle (TLV) 5304 was not accepted immediately for the Gemini program at the San Diego acceptance meeting because of an unfulfilled contractual requirement. The vehicle had completed systems test on March 23. After the technicalities were ironed out, the Air Force formally accepted TLV-5304 on April 14, and the vehicle was then shipped to Cape Kennedy by truck. En route an accident damaged the skirt on booster engine No. 1. After inspection and analysis, the contractor determined that the dented tubes resulting from the accident could be used without repair. TLV-5304 arrived at its destination on May 8 after a nine-day road trip. Following a receiving inspection, it was placed in storage May 11.

Mission Report for GT-IXA, pp. 12-10, 12-11; Quarterly Status Report No. 17, p. 17.

April
4

Atlas 5303, target launch vehicle for Gemini IX, was erected at launch complex 14. Electrical power was applied on April 11, and the Booster Flight Acceptance Composite Test was completed April 27.

Quarterly Status Report No. 17, p. 16.

12

Gemini Agena target vehicle 5005 completed modification and final assembly with the installation of a number of electrical and electronic components for which it had been waiting—including the guidance module, flight control junction box, and flight electronics package. The vehicle was transferred to test complex C-10 at Sunnyvale to begin Vehicle Systems Tests. Preliminary test tasks were completed by April 23, with preliminary inspection on April 26-27.

GATV Progress Report, April 1966, pp. 2-2, 2-4.

12

Gemini Agena target vehicle 5004 began the Combined Interface Test (CIT) at Hangar E, Eastern Test Range, after completing Plan X tests March 24. CIT ended April 22 and engine functional tests of both the primary and secondary propulsion systems followed. Hangar E testing was completed May 1.

GATV Progress Report, April 1966, p. 2-2.

13

The Electrical Interface Integrated Validation and Joint Guidance and Control Test began after Gemini launch vehicle 9 and spacecraft No. 9 were electrically mated. These activities were completed April 15. The Joint Combined Systems Test was run April 19.

Mission Report for GT-IXA, p. 12-7.

14

The Combined Systems Acceptance Test (CSAT) of Gemini launch vehicle (GLV) 10 was conducted at Martin-Baltimore. The CSAT was followed by a performance data review, completed April 19. The vehicle acceptance team convened April 26 and accepted GLV-10 on April 29. The vehicle was deerected

May 2-4 and formally accepted by the Air Force May 18. Stage I was flown to Cape Kennedy the same day, with stage II following May 20. Both stages were transferred to Hangar L where they were purged and pressurized with dry nitrogen and placed in controlled access storage.

1966
April

Mission Report for GT-X, pp. 12-7, 12-8; Aerospace *Final Report*, p. II.G-7; *Gemini-Titan II Air Force Launch Vehicle*, p. D-17.

Stage I of Gemini launch vehicle 11 was erected in the west cell of the vertical test facility at Martin-Baltimore. After completing horizontal tests April 25, stage II was erected April 29. Power was applied to the vehicle for the first time on May 9, and Subsystems Functional Verification Tests were completed June 8.

18

Mission Report for GT-XI, p. 12-7; *Gemini-Titan II Air Force Launch Vehicle*, p. D-18.

The extravehicular life support system (ELSS) for Gemini spacecraft No. 9 was returned to Cape Kennedy and underwent an electrical compatibility test with the astronaut maneuvering unit (AMU). An ELSS/AMU Joint Combined System Test was run the following day and rerun April 21. The ELSS was then delivered to Manned Spacecraft Center for tests (April 22) while the AMU was prepared for installation in the adapter. The ELSS was returned to the Cape April 26. AMU Final Systems Test and installation for flight were accomplished May 7. The ELSS was serviced and installed for flight May 16.

18

Mission Report for GT-IXA, p. 12-12.

The tanking test of Gemini launch vehicle (GLV) 9 was conducted. While the GLV was undergoing post-tanking cleanup, the spacecraft computer and extravehicular systems were retested (April 21-22), pyrotechnics were installed in the spacecraft (April 25), spacecraft final systems tests were run (April 27-28), spacecraft crew stowage was reviewed (April 29), and the astronaut maneuvering unit was reverified (April 30-May 2). On May 3 the spacecraft and launch vehicle were temporarily mated for an erector-cycling test. GLV systems were then revalidated in preparation for Simultaneous Launch Demonstration (SLD), while spacecraft extravehicular equipment was reworked and revalidated. Spacecraft and GLV were mated for flight May 8. The SLD was conducted May 10, the Final Simulated Flight Test on May 11.

20

Mission Report for GT-IXA, pp. 12-4, 12-7; *Gemini-Titan II Air Force Launch Vehicle*, p. D-15.

Gemini Program Manager Charles W. Mathews reported the launch dates tentatively scheduled for Gemini X as July 18, for Gemini XI as September 7, and for Gemini XII as October 31, 1966.

22

MSC Minutes of Senior Staff Meeting, Apr. 22, 1966, p. 3.

Gemini Agena target vehicle 5004 was transferred to complex 14 and mated to Atlas target launch vehicle 5303. Joint Flight Acceptance Composite Test was completed May 6, and Simultaneous Launch Demonstration followed on May 10.

May
2

GATV Progress Report, May 1966, p. 2-1.



Figure 122.—Demonstration of the astronaut maneuvering unit. (NASA Photo S-66-32550, May 12, 1966.)

Lockheed completed Combined Systems Acceptance Test on Gemini Agena target vehicle 5005 in test complex C-10 at Sunnyvale. The vehicle was formally accepted by the Air Force on May 14 and delivered to Eastern Test Range on May 16.

1966
May
3

Aerospace Final Report, p. III.G-3; *GATV Progress Report*, May 1966, pp. 2-2, 2-3, 3-2.

Lockheed established a task force to handle the refurbishing of Gemini Agena target vehicle (GATV) 5001 and announced a GATV 5001 Reassembly Plan. The task force's function was to see that GATV 5001 reached a flightworthy condition on time and as economically as possible. The reassembly plan provided an operational base line as well as guidelines for reassembling the vehicle, which was completely disassembled down to the level of riveted or welded parts. GATV 5001 was scheduled for acceptance on September 20 and would be the target vehicle for Gemini XII.

8

Aerospace Final Report, p. III.G-5; *GATV Progress Report*, May 1966, p. 2-8.

McDonnell delivered Gemini spacecraft No. 10 to Cape Kennedy. Installation of fuel cells was completed May 18, and that of the pyrotechnics, May 25. Preparations for Plan X testing were completed June 1, and the spacecraft was moved to Merritt Island Launch Area June 3.

13

Mission Report for GT-X, p. 12-5.

The scheduled launch of Gemini IX was postponed when target launch vehicle 5303 malfunctioned and, as a result, Gemini Agena target vehicle 5004 failed to achieve orbit. Launch and flight were normal until about 120 seconds after liftoff, 10 seconds before booster engine cutoff. At that point, booster engine No. 2 gimballed to full pitchdown position. Automatic correction was ineffective. Stabilization was achieved after booster separation, but in the meantime the vehicle had executed a 216-degree pitchdown maneuver and was pointing toward Cape Kennedy at a climbing angle of about 13 degrees above the horizontal. Ground guidance was also lost, and the vehicle continued on the new trajectory with normal sequencing through vernier engine cutoff. The Agena separated normally but could not attain orbit. It fell into the Atlantic Ocean some 90 miles off the Florida coast about seven and one-half minutes after launch. Subsequent investigation indicated that the failure had been caused by a short in the servo control circuit.

17

Quarterly Status Report No. 17, pp. 16, 22; *Aerospace Final Report*, p. IV-8; *GATV Progress Report*, May 1966, p. 2-2; *General Dynamics/Convair Test Evaluation Group*, "Space Launch Vehicle Flight Evaluation Report, SLV-3 5303," June 27, 1966 (GDC/BKF 66-029).

Recycling operations began immediately after the cancellation of the Gemini IX mission. Propellants were unloaded, and ordnance and pyrotechnics were removed from the launch vehicle and the spacecraft. Spacecraft and launch vehicle were demated May 18. Both were checked and serviced, then remated May 24 and subjected to Electrical Interface Integrated Validation. The Simulated Flight Test on May 26 completed retesting in preparation for launch on June 1. The mission was redesignated Gemini IX-A.

17

Mission Report for GT-IXA, pp. 12-4, 12-7.

1966
May
18

NASA decided to launch the augmented target docking adapter (ATDA) because of the failure on the previous day of Atlas target launch vehicle (TLV) 5303 and the loss of Gemini Agena target vehicle 5004. TLV-5304 was removed from storage and began modification to serve as the launch vehicle for the ATDA. The standard mission of the Atlas standard launch vehicle (SLV-3) was to place an Agena into a specified coast ellipse. The ATDA mission, however, required the SLV-3 to place the target into a direct-ascent Earth orbit. This called for numerous modifications. The necessity for such modifications had been anticipated when the ATDA program was initiated after the Agena failure on October 25, 1965. By March 1, 1966, there were ATDA kits ready at the Cape to modify any SLV-3 for an ATDA mission to be launched within 18 days from go-ahead. In fact, it took only 14 days. Modification was complete May 20, TLV-5304 was erected at complex 14 on May 21, TLV and ATDA were mated May 25, and all launch preparations were completed by May 30. The launch took place on June 1, the 15th day following the TLV-5303 failure.

Mission Report for GT-IXA, p. 12-11; Quarterly Status Report No. 17, p. 17; Aerospace *Final Report*, pp. IV-8, IV-9.

25

Gemini Agena target vehicle 5005 was mated to the target docking adapter (TDA) in Hangar E at Cape Kennedy. McDonnell had delivered the TDA on May 4. After mating, interface functional tests were performed, May 25-27. Preparations then began for Plan X testing with spacecraft No. 10 at Merritt Island Launch Area.

Mission Report for GT-X, p. 12-10; *GATV Progress Report*, May 1966, p. 2-3.

June
1

The augmented target docking adapter (ATDA) was launched from complex 14 at 10:00 a.m., e.s.t. The ATDA achieved a near-circular orbit (apogee 161.5, perigee 158.5 nautical miles). One hour and 40 minutes later, the scheduled launch of Gemini IX-A was postponed by a ground equipment failure which prevented the transfer of updating information from Cape Kennedy mission control center to the spacecraft computer. The mission was recycled for launch on June 3, following a prepared 48-hour recycle plan.

Mission Report for GT-IXA, pp. 1-1, 1-2, 5-143; *Gemini-Titan II Air Force Launch Vehicle*, p. D-16; Kuras and Albert, "Gemini-Titan Technical Summary," pp. 147-148.

1

Gemini Agena target vehicle 5005 completed preliminary testing at Hangar E, Eastern Test Range, and was moved to Merritt Island Launch Area for Plan X tests with spacecraft No. 10. Plan X tests had first been scheduled for May 23 but were rescheduled for June 2-3. To avoid an impact on the schedule, the delay was absorbed by conducting several activities normally performed after Plan X: secondary propulsion system (SPS) modules fit check and alignment, SPS heatshield fit check, and booster adapter fit check. But the vehicle work plan was again rescheduled, and Plan X did not begin until June 7. Following the successful completion of Plan X on June 8, the vehicle was returned to Hangar E for systems verification tests, which began on June 9. Cause of rescheduling was the Gemini IX-A launch.

Mission Report for GT-X, p. 12-10; *GATV Progress Reports*: May, p. 2-3; June 1966, p. 2-1.

Gemini IX-A, the seventh manned and third rendezvous mission of the Gemini program, was launched from complex 19 at 8:39 a.m., e.s.t. Major objectives of the mission, crewed by command pilot Astronaut Thomas P. Stafford and pilot Astronaut Eugene A. Cernan, were to rendezvous and dock with the augmented target docking adapter (ATDA) and to conduct extravehicular activities (EVA). These objectives were only partially met. After successfully achieving rendezvous during the third revolution—a secondary objective—the crew discovered that the ATDA shroud had failed to separate, precluding docking—a

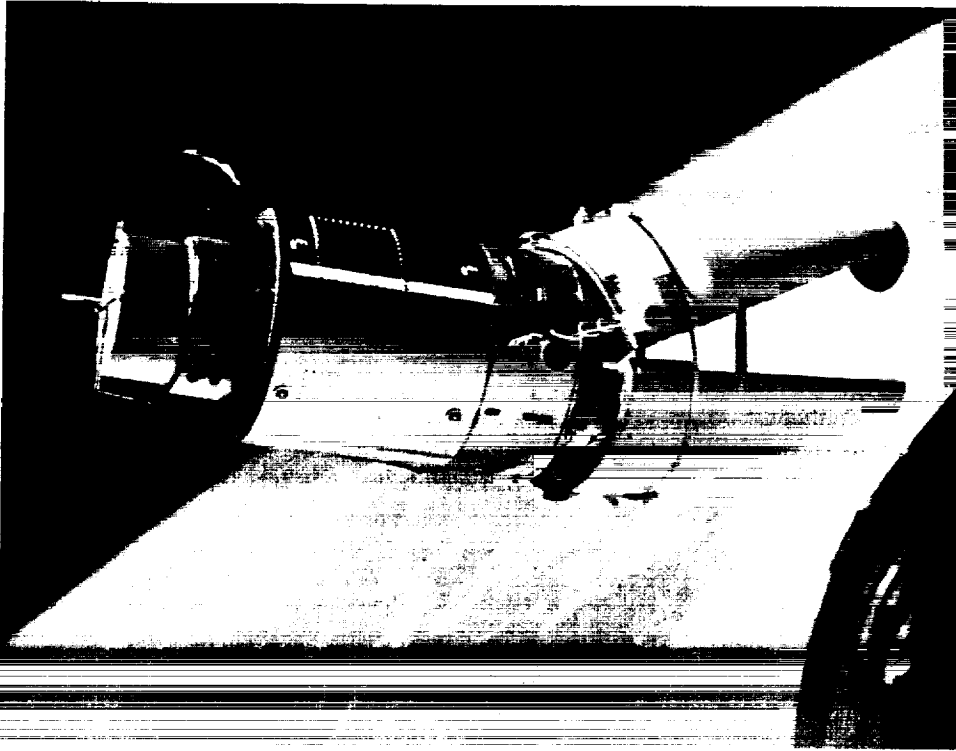

Figure 123.—The augmented target docking adapter with shroud partly open and still attached, as seen from the Gemini IX-A spacecraft in orbit. Shroud's failure to separate precluded docking. (NASA Photo No. 66-H-725, released June 7, 1966.)

primary objective—as well as docking practice—another secondary objective. The crew was able, however, to achieve other secondary objectives: an equi-period rendezvous, using onboard optical techniques and completed at 6 hours 36 minutes ground elapsed time; and a rendezvous from above, simulating the rendezvous of an Apollo command module with a lunar module in a lower orbit (completed at 21 hours 42 minutes ground elapsed time). Final separation maneuver was performed at 22 hours 59 minutes after liftoff. EVA was postponed because of crew fatigue, and the second day was given over to experiments. The hatch was opened for EVA at 49 hours 23 minutes ground elapsed time. EVA was successful, but one secondary objective—evaluation of the astronaut maneuvering unit (AMU)—was not achieved because Cernan's visor began fogging. The extravehicular life support system apparently became overloaded with moisture when Cernan had to work harder than anticipated to prepare the AMU

PROJECT GEMINI: A CHRONOLOGY

1966
June

for donning. Cernan reentered the spacecraft, and the hatch was closed at 51 hours 28 minutes into the flight. The rest of the third day was spent on experiments. Following the third sleep period, the crew prepared for retrofire, which was initiated during the 45th revolution. The spacecraft landed within a mile of the primary recovery ship, the aircraft carrier *Wasp*. The crew remained with the spacecraft, which was hoisted aboard 53 minutes after landing.

Mission Report for GT-IXA, pp. 1-1 to 1-3, 2-1, 2-2, 4-1 to 4-3; Fact Sheet 291-F, *Gemini IX-A, Rendezvous Mission*, August 1966; McDonnell *Final Report*, pp. 76-77.

- 6 Gemini Agena target vehicle 5006 completed modification and final assembly and was transferred to Vehicle Systems Test (VST) at Sunnyvale. Although the vehicle lacked the flight control electronics package and guidance module, testing began immediately. The guidance module was received June 7 and the flight control electronics package June 9. Preliminary VST was completed June 17. The Air Force Plant Representative Office at Sunnyvale authorized final acceptance test to begin on June 20.
- GATV Progress Report*, June 1966, pp. 2-2, 2-3.
- 7 The acceptance meeting for target launch vehicle (TLV) 5305 was held at General Dynamics/Convair in San Diego. TLV systems test had originally been completed March 25. During the next two months, TLV components were reworked to the latest flight configuration. Systems tests were then rerun, May 26-June 1, followed by composite test June 2-3. Following acceptance, the vehicle was shipped by air on June 9 to Cape Kennedy; this was the first TLV to be transported by air to the Cape, and it arrived the same day.
- Mission Report for GT-X, p. 12-11; Quarterly Status Report No. 18 for Period Ending Aug. 31, 1966, p. 15.
- 7 Gemini launch vehicle 10 was removed from storage and erected at complex 19. Umbilicals were connected and power applied June 9. Subsystems Reverification Tests (SSRT) began immediately. SSRT ended June 16, and the Prespacecraft Mate Verification Combined Systems Test was conducted June 17.
- Mission Report for GT-X, p. 12-8; *Gemini-Titan II Air Force Launch Vehicle*, p. D-17.
- 9 Gemini spacecraft No. 10 was moved to complex 19 and hoisted to the top of its launch vehicle. Cabling for test was completed June 13. Premate verification, as well as fuel cell activation and deactivation, were completed June 16. Preparation for integrated tests with the launch vehicle was accomplished the following day.
- Mission Report for GT-X, p. 12-5.
- 9 The launch vehicle acceptance test of Gemini launch vehicle (GLV) 11 was conducted. The vehicle acceptance team convened June 20 and accepted GLV-11 June 24. The vehicle was deerected June 29 and formally accepted by the Air Force on July 11. Stage I was delivered by air to Cape Kennedy the same day and stage II on July 13. Both stages were transferred to Hangar U where the tanks were purged and pressurized. The stages remained in controlled access

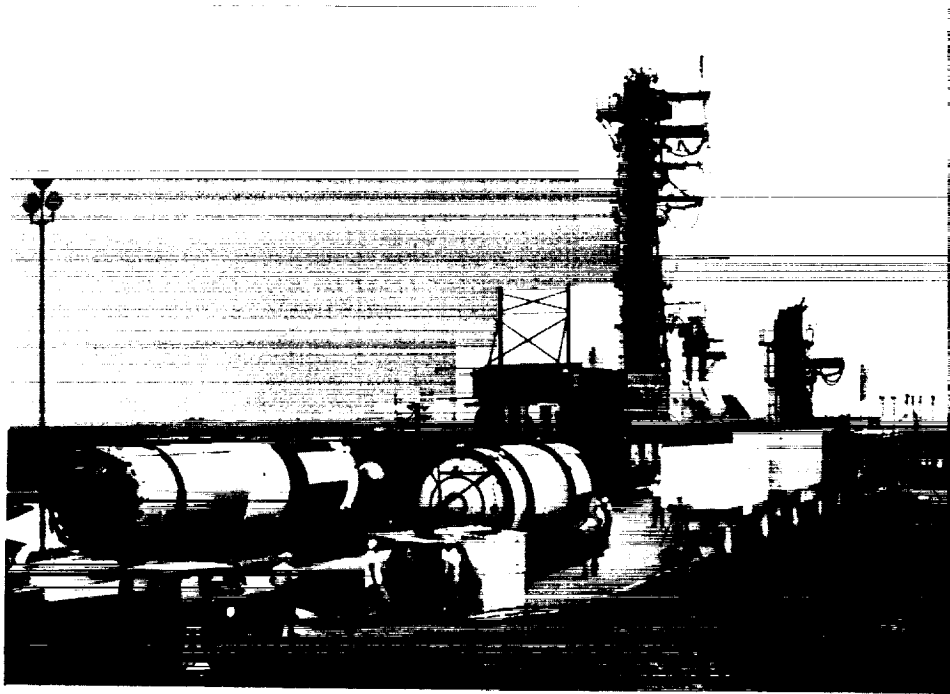

Figure 124.—The first and second stages of Gemini launch vehicle 11 arriving at complex 19. (NASA Photo No. 66-H-1045, released July 23, 1966.)

storage until the launch pad was revalidated after the launch of Gemini X; revalidation was completed July 21.

1966
June

Mission Report for GT-XI, pp. 12-7, 12-8; Aerospace Final Report, p. II.G-7; Gemini-Titan II Air Force Launch Vehicle, pp. D-18, D-19.

Combined Interface Tests (CIT) of Gemini Agena target vehicle (GATV) 5005 began. CIT was completed June 22, with no significant anomalies detected. Primary and secondary propulsion system functional checks were completed June 30. The GATV was then moved to complex 14.

13

GATV Progress Report, June 1966, p. 2-1.

Atlas 5305, target launch vehicle for Gemini X, was erected at launch complex 14. Electrical power was applied June 17, and subsystem testing was completed June 28. During propellant system checks, a leak was discovered in the fuel start tank. Access to repair the leak required removing the sustainer engine and the fuel tank apex cone.

15

Mission Report for GT-X, p. 12-12; Quarterly Status Report No. 18, p. 15.

During the Gemini IX-A postlaunch press conference with Astronauts Thomas P. Stafford and Eugene A. Cernan, Director Robert R. Gilruth of Manned Spacecraft Center announced that James A. Lovell, Jr., and Edwin E. Aldrin, Jr., would be the prime crew for the last Gemini flight, Gemini XII. The backup

17

PROJECT GEMINI: A CHRONOLOGY

1966 crew would be L. Gordon Cooper, Jr., and Eugene A. Cernan. The mission was
June scheduled for late October or early November.

MSC *Space News Roundup*, June 24, 1966, p. 8.

17 Gemini launch vehicle 12 stage I was erected in the east test cell of the vertical
test facility at Martin-Baltimore. Stage II was erected June 22. Power was
applied July 6, and Subsystems Functional Verification Tests were completed
July 11.

Mission Report for GT-XII, p. 12-7; *Gemini-Titan II Air Force Launch Vehicle*, p.
D-20.

19 NASA announced that the Gemini X mission had been scheduled for no earlier
than July 18, with John W. Young, command pilot, and Michael Collins, pilot,
as the prime crew. Alan L. Bean, command pilot, and Clifton C. Williams, pilot,
would be the backup crew. Mission plans would include rendezvous, docking,
and extravehicular activity. The spacecraft was scheduled to rendezvous and
dock with an Agena target vehicle which was to be launched the same day. If
possible, Gemini X would also rendezvous with the Agena launched in the March
16 *Gemini VIII* mission.

NASA News Release 66-155, June 19, 1966.

20 Gemini launch vehicle 10 and spacecraft No. 10 were electrically mated at com-
plex 19. The Electrical Interface Integrated Validation and Joint Guidance and
Control Test was conducted June 20-21. Following a data review, the Joint
Combined Systems Test was run June 23.

Mission Report for GT-X, p. 12-8.

24 The tanking test of Gemini launch vehicle (GLV) 10 was conducted. During the
post-tanking cleanup and systems testing of the GLV, spacecraft No. 10 hyper-
golics were serviced (June 27-28), spacecraft Final Systems Tests were con-
ducted (June 28-July 1), crew stowage was evaluated, and the extravehicular
life support system was checked (July 1). On July 5, spacecraft and GLV were
mechanically mated and the erector was cycled. The electrical interface was
retested July 6. The Simultaneous Launch Demonstration on July 12 and Simu-
lated Flight Test on July 13 completed prelaunch testing.

Mission Report for GT-X, p. 12-8.

27 Final acceptance test of Gemini Agena target vehicle 5006 was completed
at Sunnyvale. The vehicle was disconnected from the test complex July 6
and formally accepted by the Air Force on July 13, two days ahead of schedule.
Shipment of the vehicle to Eastern Test Range (ETR), planned for July 13,
was delayed until July 14 by wind conditions. It arrived at ETR in the early
morning of July 15.

Mission Report for GT-XI, p. 12-10; *GATV Progress Reports*: June, p. 2-3; July
1966, p. 2-4.

July Gemini Agena target vehicle 5005 was transferred to complex 14 and mated to
1 target launch vehicle 5305. Joint Flight Acceptance Composite Test was com-

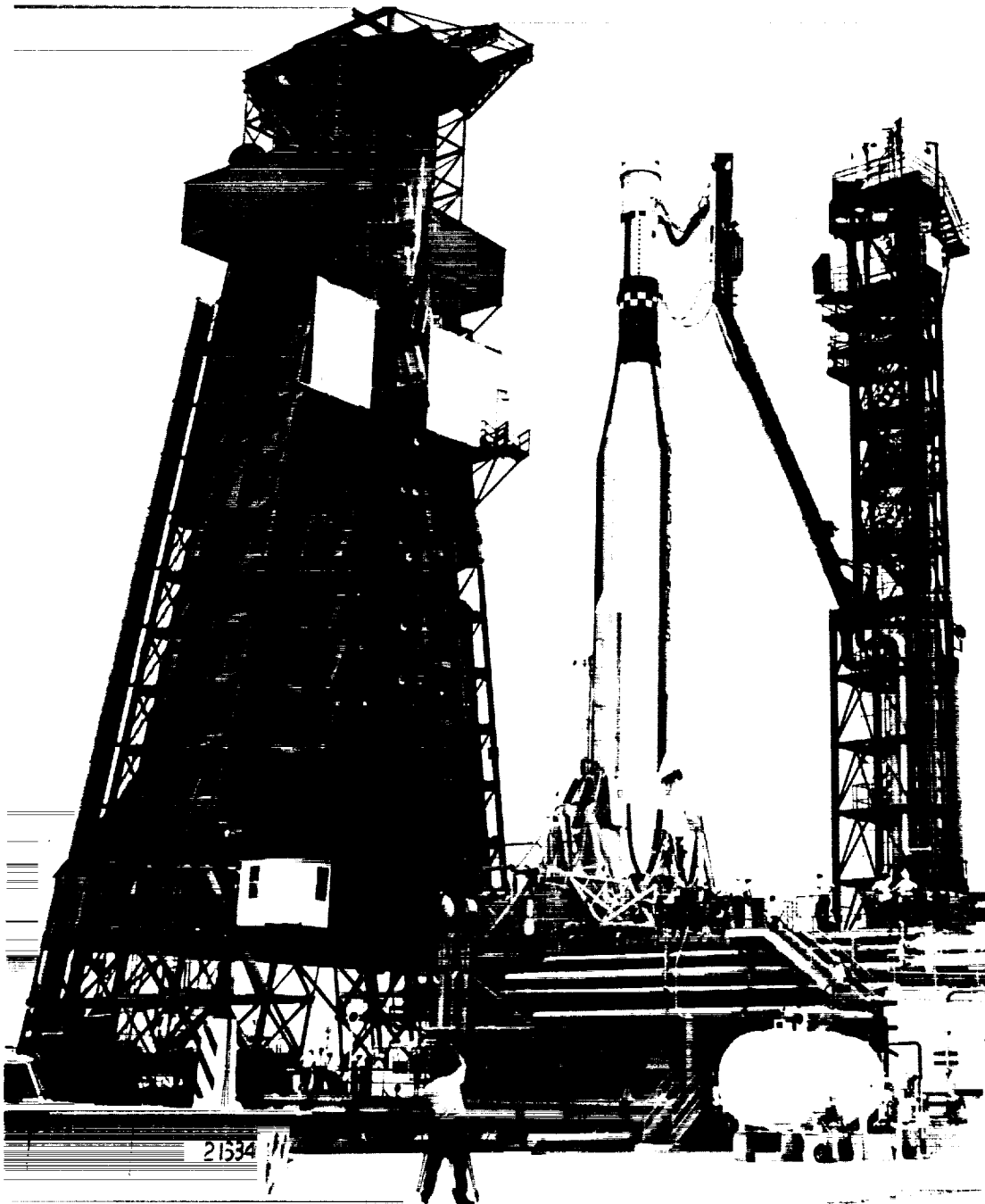

Figure 125.—The Gemini Atlas-Agena target vehicle undergoing systems tests at complex 14 prior to the Gemini X mission. (NASA Photo No. 66-H-989, released July 18, 1966.)

pleted July 8. Complex 14 systems tests were completed July 12 with the Simultaneous Launch Demonstration.

1966
July

Mission Report for GT-X, p. 12-10; *GATV Progress Report*, July 1966, pp. 2-3, 2-4.

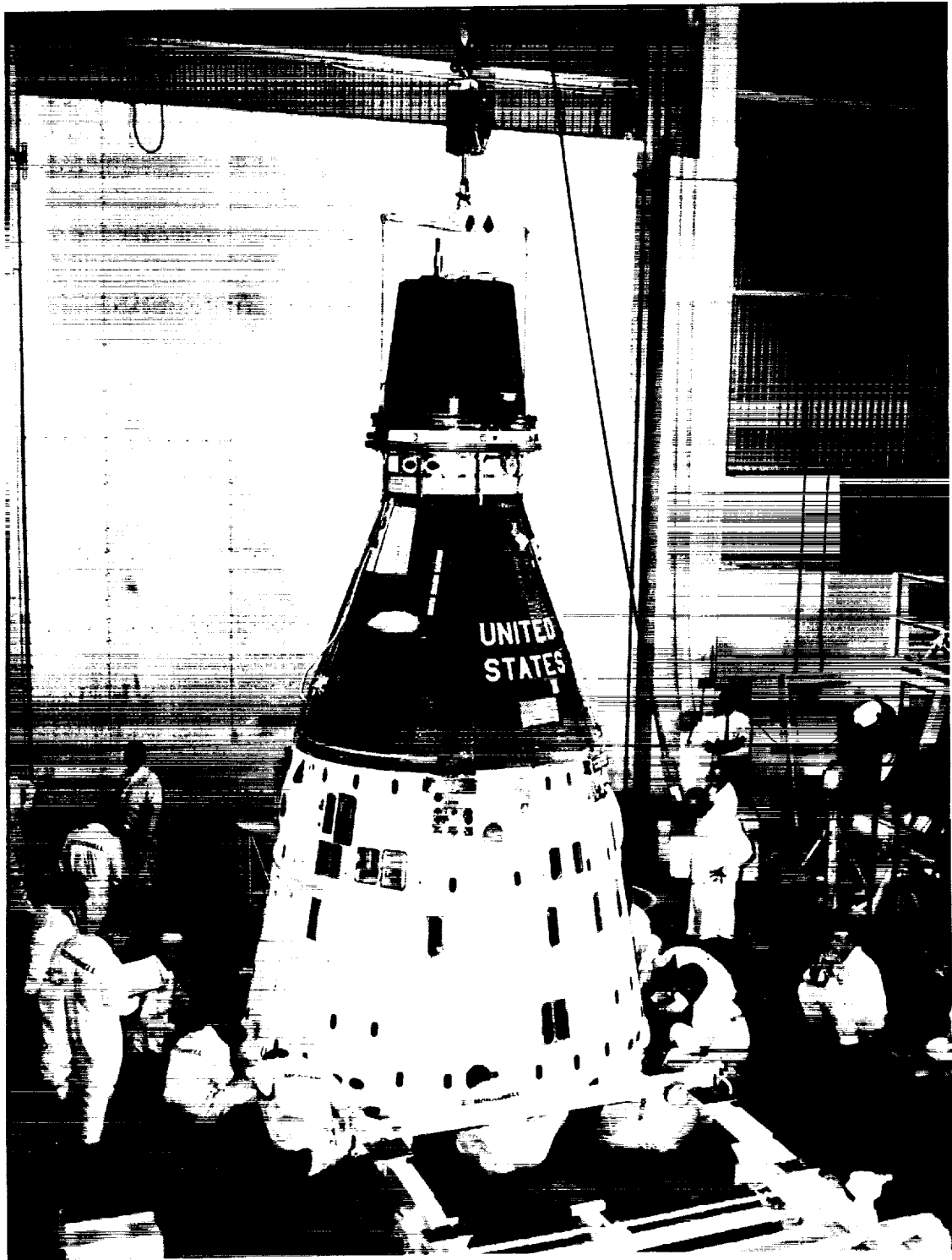

Figure 126.—McDonnell personnel bolting the Gemini XI spacecraft to a support ring for boresighting in the Pyrotechnic Installation Building, Merritt Island. (NASA Photo S-66-47635, July 2, 1966.)

McDonnell delivered Gemini spacecraft No. 11 to Cape Kennedy. After fuel and pyrotechnic installation and preliminary checks, the spacecraft was moved to the Merritt Island Launch Area for Plan X integrated tests with the target vehicle on July 25.

1966
July
7

Mission Report for GT-XI, p. 12-5.

The acceptance meeting for Atlas 5306, the target launch vehicle for Gemini XI, was held at San Diego. Final acceptance was completed July 18. The vehicle was shipped the same day by air to Cape Kennedy, arriving July 19.

15

Quarterly Status Report No. 18, p. 15.

Gemini Agena target vehicle (GATV) 5006 was mated to target docking adapter (TDA) 6. McDonnell had delivered TDA-6 to Cape Kennedy July 7. The interface functional test was completed July 21. The next day GATV 5006 was moved to the Merritt Island Launch Area for integrated tests with spacecraft No. 11 and extravehicular equipment.

18

Mission Report for GT-XI, p. 12-10; *GATV Progress Report*, July 1966, p. 2-4.

The *Gemini X* mission began with the launch of the Gemini Atlas-Agena target vehicle from complex 14 at 3:40 p.m., e.s.t. The Gemini space vehicle, manned by command pilot Astronaut John W. Young and pilot Astronaut Michael Collins, was launched from complex 19 at 5:20 p.m. The Gemini Agena target vehicle (GATV) attained a near-circular, 162- by 157-nautical-mile orbit. Spacecraft No. 10 was inserted into a 145- by 86-nautical-mile elliptical orbit. Slant range between the two vehicles was very close to the nominal 1000 miles. Major objective of the mission was achieved during the fourth revolution when the spacecraft rendezvoused with the GATV at 5 hours 23 minutes ground elapsed time and docked with it about 30 minutes later. More spacecraft propellant was used to achieve rendezvous than had been predicted, imposing constraints on the remainder of the mission and requiring the development of an alternate flight plan. As a result, several experiments were not completed, and another secondary objective—docking practice—was not attempted. To conserve fuel and permit remaining objectives to be met, the spacecraft remained docked with the GATV for about 39 hours. During this period, a bending mode test was conducted to determine the dynamics of the docked vehicles, standup extravehicular activities (EVA) were conducted, and several experiments were performed. The GATV primary and secondary propulsion systems were used for six maneuvers to put the docked spacecraft into position for rendezvous with the *Gemini VIII* GATV as a passive target. The spacecraft undocked at 44 hours 40 minutes ground elapsed time, separated from the GATV, and used its own thrusters to complete the second rendezvous some three hours later. At 48 hours and 42 minutes into the flight, a 39-minute period of umbilical EVA began, which included the retrieval of a micrometeorite collection package from the *Gemini VIII* Agena. The hatch was opened a third time about an hour later to jettison extraneous equipment before reentry. After about three hours of stationkeeping, the spacecraft separated from the GATV. At 51 hours 39 minutes ground elapsed time, the crew performed a true anomaly-adjust maneuver to minimize reentry dispersions resulting from the retrofire maneuver. The retrofire maneuver was initiated at 70 hours 10 minutes after

18

PROJECT GEMINI: A CHRONOLOGY

1966
July

liftoff, during the 43rd revolution. The spacecraft landed within sight of the prime recovery ship, the aircraft carrier *Guadaluacanal*, some three miles from the planned landing point, at 4:07 p.m., July 21.

Mission Report for GT-X, pp. 1-1 to 1-3, 2-1, 2-2, 4-1, 4-2, 4-35; Fact Sheet 291-G, *Gemini X, Multiple Rendezvous, EVA Mission*, September 1966.

- 21 Following the reentry of spacecraft No. 10, Gemini Agena target vehicle (GATV) 5005 made three orbital maneuvers under ground control. Its primary propulsion system (PPS) fired to put the vehicle in a 750.5- by 208.6-nautical-mile orbit in order to determine the temperature effects of such an orbit on the vehicle. Temperature data showed no appreciable difference from that obtained at lower orbits. The PPS fired again to circularize the orbit and a secondary propulsion system Unit II maneuver placed the GATV in a 190-nautical-mile circular orbit for possible use as a Gemini XI rendezvous target. During its time in orbit, the GATV received and executed 1700 commands, 1350 by ground controllers and 350 from spacecraft 10.

Mission Report for GT-X, pp. 1-3, 4-35, 5-140; Fact Sheet 291-G.

- 21 Gemini Agena target vehicle 5001 was transferred to systems test complex C-10 at Sunnyvale, after the long process of refurbishing it had been completed; however, it was still short several pieces of equipment.

GATV Progress Report, July 1966, p. 2-6.

- 22 Gemini launch vehicle 11 was removed from storage and erected at complex 19. After the vehicle was inspected and umbilicals connected, power was applied July 27, and Subsystems Reverification Tests (SSRT) began. SSRT ended August 4, and the Prespacecraft Mate Verification Combined Systems Test was run the following day.

Mission Report for GT-XI, p. 12-8; *Gemini-Titan II Air Force Launch Vehicle*, p. D-19.

- 26 After completing Plan X tests at Merritt Island Launch Area, Gemini target vehicle (GATV) 5006 returned to Hangar E to begin systems verification tests. Combined Interface Tests began August 4 and ended August 12. Primary and secondary propulsion system (PPS and SPS) functional tests began August 13. SPS functionals were completed August 18, and the SPS modules were installed August 19. PPS functionals were completed August 21. GATV 5006 was then transferred to complex 14 for mating with the Atlas.

Mission Report for GT-XI, p. 12-10; *GATV Progress Report*, August 1966, p. 2-1.

- 28 Atlas 5306, the target launch vehicle (TLV) for Gemini XI, was erected at launch complex 14. Electrical power was applied the following day. The dual propellant loading (DPL) was run August 18, after a number of liquid oxygen leaks had been eliminated. A discrepancy noted in the vernier engine liquid oxygen bleed system during the first loading required a second DPL, successfully completed on August 22. The Booster Flight Acceptance Composite Test was successfully completed on August 19, and the TLV and Gemini Agena target vehicle were mated on August 22.

Mission Report for GT-XI, p. 12-12; Quarterly Status Report No. 18, pp. 15-16.

PART III—FLIGHT TESTS

Gemini spacecraft No. 11 was moved to complex 19 and hoisted atop its launch vehicle. Cabling was completed August 1, and the Premate Systems Test was conducted August 1-3. Some fuel cell sections were replaced August 4, when checks revealed high leakage rates. Fuel cell activation and deactivation were completed August 6. 1966
July
28

Mission Report for GT-XI, pp. 12-5, 12-6.

The launch vehicle acceptance test of Gemini launch vehicle (GLV) 12 was conducted. The vehicle acceptance team convened August 9 and accepted the vehicle August 12. GLV-12 was deerected August 17 and formally accepted by the Air Force August 30. Stage I was airlifted to Cape Kennedy the same day. Stage II arrived September 3. Both stages were placed in controlled access storage in Hangar T pending the launch of Gemini XI and the revalidation of the launch pad, completed September 16. 29

Mission Report for GT-XII, pp. 12-7, 12-8; Aerospace *Final Report*, p. II.G-7; *Gemini-Titan II Air Force Launch Vehicle*, p. D-20.

Gemini launch vehicle 11 and spacecraft No. 11 were electrically mated at complex 19. Electrical Interface Integrated Validation and Joint Guidance and Control Test was conducted August 8-9. The Joint Combined Systems Test followed August 11-12. August
8

Mission Report for GT-XI, p. 12-8.

The tanking test of Gemini launch vehicle (GLV) 11 was conducted. While GLV post-tanking operations were being performed, the Final Systems Tests of spacecraft No. 11 were conducted August 22-23. Spacecraft and GLV were mechanically mated August 24 and erector cycling was tested. The electrical interface was revalidated August 25-29. The Simultaneous Launch Demonstration on August 31 and the Simulated Flight Test on September 1 completed prelaunched testing. 15

Mission Report for GT-XI, p. 12-8.

Gemini Agena target vehicle 5001 completed final acceptance testing. Analysis of test data was completed by August 24 and the vehicle was disconnected from the test complex. 16

GATV Progress Report, August 1966, pp. 2-3, 2-4.

Gemini Agena target vehicle 5006 was mated to target launch vehicle 5306. Joint Flight Acceptance Composite Test was performed August 26, Simultaneous Launch Demonstration on August 31. 22

Mission Report for GT-XI, p. 12-10; *GATV Progress Report*, August 1966, pp. 2-1, 2-2.

Gemini Agena target vehicle 5001 was formally accepted by the Air Force after vehicle acceptance team inspection. It was shipped from Sunnyvale on September 3 and arrived at Eastern Test Range on September 4. September
2

Mission Report for GT-XII, p. 12-10; *GATV Progress Report*, September 1966, pp. 2-1, 5-1.

PROJECT GEMINI: A CHRONOLOGY

1966
September
6

McDonnell delivered Gemini spacecraft No. 12 to Cape Kennedy. After preliminary installations were completed, the spacecraft was moved to the Merritt Island Launch Area for integrated tests with the target vehicle (September 19-20).

Mission Report for GT-XII, p. 12-5.

- 9 The scheduled launch of Gemini XI was postponed when a pinhole leak was discovered in the stage I oxidizer tank of the launch vehicle shortly after propellants had been loaded. The decision to repair the leak required rescheduling the launch for September 10. After propellants were unloaded, the leak was plugged with a sodium silicate solution and covered with an aluminum patch.

Mission Report for GT-XI, pp. 5-106, 5-107; *Gemini-Titan II Air Force Launch Vehicle*, p. D-19; Kuras and Albert, "Gemini-Titan Technical Summary," p. 149.

- 10 The scheduled Atlas-Agena launch was postponed because of apparent problems with the target launch vehicle autopilot. It was later determined that the problems were caused by a combination of propellant sloshing, wind loading, and autopilot recorder sensitivity. The circumstances were determined to be normal and hardware replacement was not required. Launch was rescheduled for September 12.

Mission Report for GT-XI, pp. 5-107, 6-2; Quarterly Status Report No. 19 for Period Ending Nov. 30, 1966, p. 11.

- 12 The *Gemini XI* mission began with the launch of the Gemini Atlas-Agena target vehicle from complex 14 at 8:05 a.m., e.s.t. The Gemini space vehicle,

Figure 127.—Astronaut Richard F. Gordon, Jr., returning to the hatch of Gemini XI after extravehicular activity. (NASA Photo No. 66-H-1249, released Sept. 13, 1966.)



1966
September

carrying command pilot Astronaut Charles Conrad, Jr., and pilot Astronaut Richard F. Gordon, Jr., was launched from complex 19 at 9:42 a.m. The primary objective of the *Gemini XI* mission was to rendezvous with the Gemini Agena target vehicle (GATV) during the first revolution and dock. Five maneuvers completed the spacecraft/GATV rendezvous at 1 hour 25 minutes ground elapsed time, and the two vehicles docked nine minutes later. Secondary objectives included docking practice, extravehicular activity (EVA), 11 experiments, docked maneuvers, a tethered vehicle test, demonstrating automatic reentry, and parking the GATV. All objectives were achieved except one experiment—evaluation of the minimum reaction power tool—which was not performed because umbilical EVA was terminated prematurely. Umbilical EVA began at 24 hours 2 minutes ground elapsed time and ended 33 minutes later. Gordon became fatigued while attaching the tether from the GATV to the spacecraft docking bar. An hour later the hatch was opened to jettison equipment no longer required. At 40 hours 30 minutes after liftoff, the GATV.

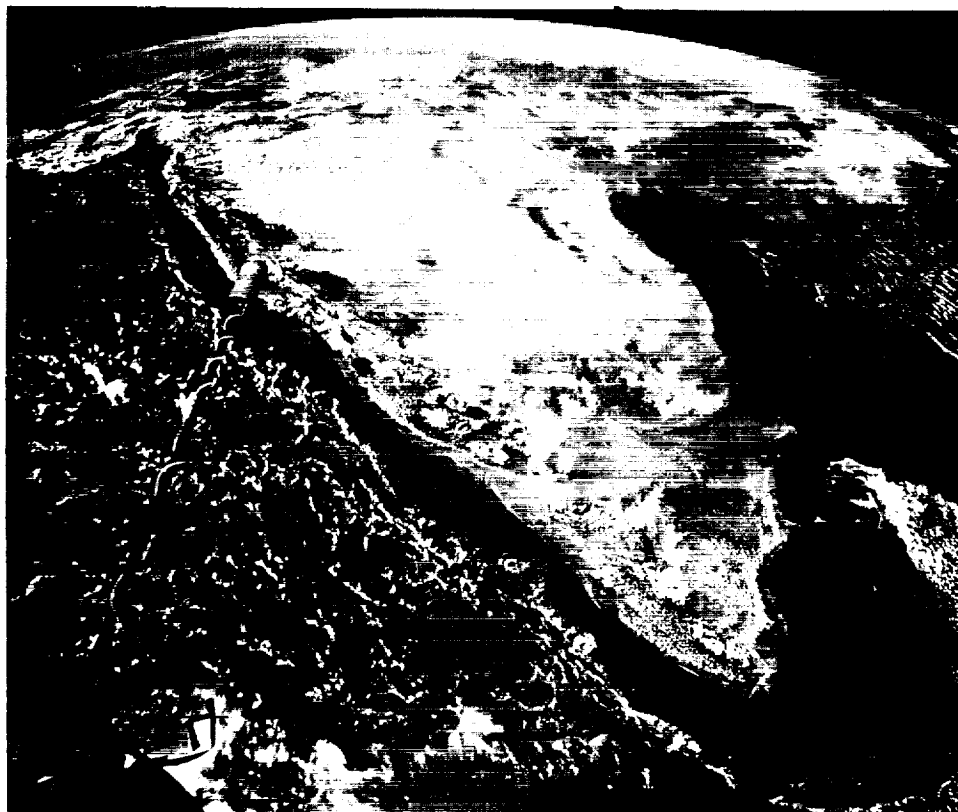

Figure 128.—View of India and Ceylon from Gemini XI at 540 nautical miles looking north, with the Bay of Bengal to the right and the Arabian Sea to the left. (NASA Photo No. 66-H-1246 [66-HC-1608], released Sept. 17, 1966.)

primary propulsion system (PPS) was fired to raise the apogee of the docked vehicles to 741 nautical miles for two revolutions. The PPS was fired again, 3 hours 23 minutes later, to reduce apogee to 164 nautical miles. The crew then prepared for standup EVA, which began at 47 hours 7 minutes into the flight

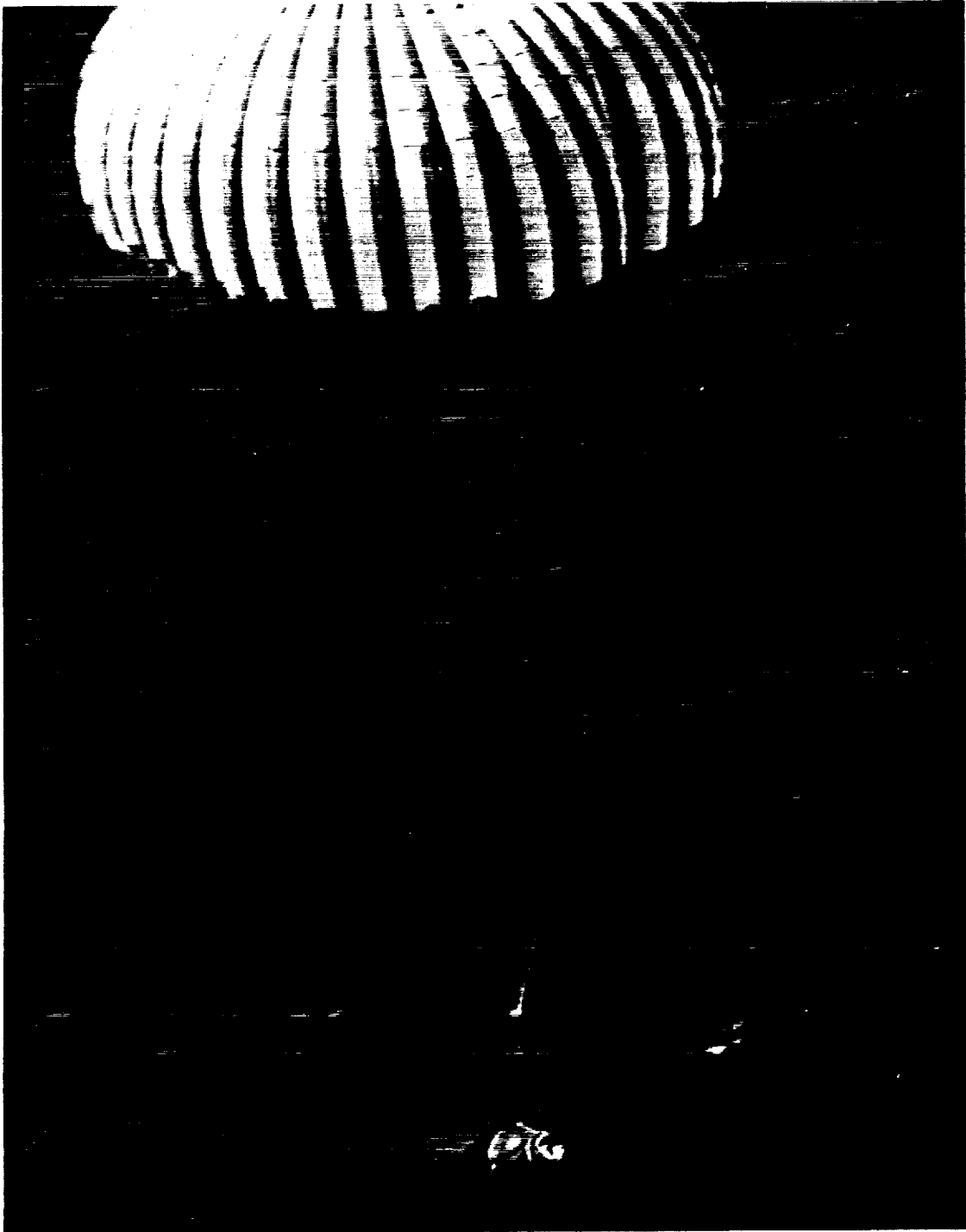

Figure 129.—The Gemini XI spacecraft landing approach in the western Atlantic. (NASA Photo No. 66-H-1214, released Sept. 15, 1966.)

1966
September

and lasted 2 hours 8 minutes. The spacecraft was then undocked to begin the tether evaluation. At 50 hours 13 minutes ground elapsed time, the crew initiated rotation. Initial oscillations damped out and the combination became very stable after about 20 minutes; the rotational rate was then increased. Again, initial oscillations gradually damped out and the combination stabilized. At about 53 hours into the mission, the crew released the tether, separated from the GATV, and maneuvered the spacecraft to an identical orbit with the target vehicle. A fuel cell stack failed at 54 hours 31 minutes, but the remaining five stacks shared the load and operated satisfactorily. A rendezvous was accomplished at 66 hours 40 minutes ground elapsed time, and the crew then prepared for reentry. The spacecraft landed less than three miles from the planned landing point at 71 hours 17 minutes after liftoff. The crew was retrieved by helicopter, and the spacecraft was brought aboard the prime recovery ship, the aircraft carrier *Guam*, about an hour after landing.

Mission Report for GT-XI, pp. 1-1 to 1-4, 2-1, 4-1 to 4-3; Fact Sheet 291-H, *Gemini XI Mission, High Altitude, Tethered Flight*, October 1966.

Gemini Agena target vehicle 5001 was mated to target docking adapter (TDA) 7A at Cape Kennedy. McDonnell had delivered TDA 7A to the Cape August 19. After functional verification tests (September 13-15), the vehicle was moved (September 19-20) to the Merritt Island Launch Area for Plan X integrated tests with spacecraft No. 12.

12

Mission Report for GT-XII, p. 12-10.

The acceptance meeting for target launch vehicle (TLV) 5307 was conducted at San Diego. The vehicle was shipped to Cape Kennedy following acceptance, arriving September 20. This vehicle had originally been assigned to the Lunar Orbiter program. The Atlas 5305 failure on May 17, however, followed by the decision to use Atlas 5304 to launch the augmented target docking adapter, made it necessary to procure an additional TLV for the Gemini Program. In May, Gemini Program Office (GPO) completed negotiations to acquire Atlas 7127 from Vandenberg Air Force Base, California. This vehicle was so different from the Gemini TLV, however, that GPO decided to use the Lunar Orbiter vehicle, Atlas 5803, redesignating it TLV 5307. This vehicle had only nine minor engineering change proposal (ECP) differences from earlier TLVs, all of which analysis showed to be acceptable. Modification for the Gemini program was completed August 22 and factory testing on September 12.

16

Mission Report for GT-XII, pp. 12-11, 12-12; Quarterly Status Reports: No. 17, p. 18; No. 18, p. 16; No. 19, p. 11.

Gemini launch vehicle (GLV) 12 was removed from storage and erected at complex 19. Umbilicals were connected after GLV inspection September 21. Power was applied the next day and Subsystems Reverification Tests (SSRT) began September 23. SSRT ended October 2 and Prespacecraft Mate Verification Combined Systems Test was run October 4.

19

Mission Report for GT-XII, p. 12-8; *Gemini-Titan II Air Force Launch Vehicle*, p. D-20.

Gemini Agena target vehicle (GATV) 5001 was returned to Hangar E and began systems test after completing Plan X tests at the Merritt Island Launch

21

PROJECT GEMINI: A CHRONOLOGY

1966
September

Area. Systems testing was completed September 29. The Combined Interface Test (September 29–October 13) was followed by functional tests of the primary and secondary propulsion systems, completed October 22. GATV 5001 was then moved to complex 14.

Mission Report for GT-XII, p. 12–10; *GATV Progress Report*, October 1966, p. 2–1.

23

The astronaut maneuvering unit (AMU), which had been installed in Gemini spacecraft No. 12 on September 17, was removed as the spacecraft was undergoing final preparations for movement to complex 19. NASA Headquarters deleted the AMU experiment from the extravehicular activities (EVA) planned for the Gemini XII mission. Persistent problems in performing EVA on earlier flights had slowed the originally planned step-by-step increase in the complexity of EVA. With only one flight left, George E. Mueller, NASA Associate Administrator for Manned Space Flight, felt that more work was required on EVA fundamentals—the performance of easily monitored and calibrated basic tasks. On this flight, the pilot would remove, install, and tighten bolts, operate connectors and hooks, strip velcro, and cut cables.

Mission Report for GT-XII, p. 12–5; letter, Mueller to Gen. James R. Ferguson, Sept. 30, 1966.

23

Gemini spacecraft No. 12 was moved to complex 19 and hoisted to the top of the launch vehicle. Premate verification was completed October 3.

Mission Report for GT-XII, p. 12–5.

26

Target launch vehicle 5307 was erected at complex 14. Systems tests began the next day and lasted until October 18. The Booster Flight Acceptance Composite Test was conducted October 24.

Mission Report for GT-XII, p. 12–12.

October
5

Gemini launch vehicle 12 and spacecraft No. 12 were electrically mated at complex 19. The Electrical Interface Integrated Validation and Joint Guidance and Control Test was conducted October 5–6, and data was reviewed the following day. The Joint Combined Systems Test was run on October 10.

Mission Report for GT-XII, p. 12–8; Kuras and Albert, "Gemini-Titan Technical Summary," p. 150.

11

The tanking test of Gemini launch vehicle (GLV) 12 was conducted. While the GLV was being cleaned up after the tanking test, the Final Systems Test of spacecraft No. 12 was conducted October 17–19. Spacecraft and GLV were mechanically mated October 25 and the erector was cycled. The spacecraft guidance system was retested October 26–27, and the spacecraft/GLV electrical interface was revalidated October 28. The Simultaneous Launch Demonstration on November 1 and the Simulated Flight Test on November 2 completed pre-launch testing and checkout.

Mission Report for GT-XII, pp. 12–5, 12–8; *Gemini-Titan II Air Force Launch Vehicle*, p. D–20.

23

Gemini Agena target vehicle 5001 was mated to target launch vehicle 5307

on complex 14. Joint Flight Acceptance Composite Test was completed October 28, Simultaneous Launch Demonstration on November 1.

GATV Progress Report, October 1966, p. 2-2.

1966
October

The scheduled launch of Gemini XII was postponed by a malfunctioning power supply in the launch vehicle secondary autopilot, discovered before the countdown for the November 9 launch began. The secondary autopilot package and the secondary stage I rate gyro package were replaced, and the mission was rescheduled for November 10. During tests of the replacement autopilot on November 9, another malfunction occurred, which was resolved by again replacing the secondary autopilot package. The launch was rescheduled for November 11.

November
8

Mission Report for GT-XII, pp. 5-111, 5-112, 12-22, 12-23; *Gemini-Titan II Air Force Launch Vehicle*, p. D-21; Kuras and Albert, "Gemini-Titan Technical Summary," p. 150.

The Gemini Atlas-Agena target vehicle for the *Gemini XII* mission was launched from complex 14 at 2:08 p.m., e.s.t. The Gemini space vehicle, manned by command pilot Astronaut James A. Lovell, Jr., and pilot Astronaut Edwin E. Aldrin, Jr., was launched from complex 19 at 3:47 p.m. Major objectives of the mission were to rendezvous and dock and to evaluate extravehicular activities (EVA). Among the secondary objectives were tethered vehicle evaluation, experiments, third revolution rendezvous and docking, automatic reentry dem-

11

Figure 130.—Astronaut Edwin E. Aldrin, Jr., carrying a micrometeoroid package to the spacecraft from the adapter section during extravehicular activity on Gemini XII. (NASA Photo No. 66-H-753 [66-HC-1546], released Nov. 16, 1966.)

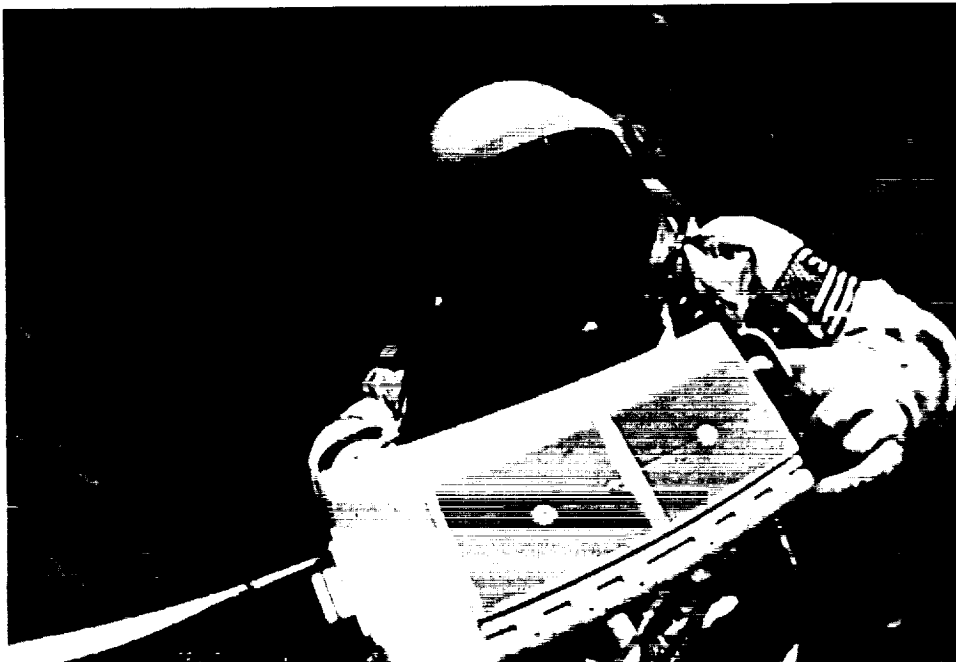



Figure 131.—The Gemini Agena target vehicle tethered to the spacecraft during the Gemini XII mission. (NASA Photo No. 66-H-751, released Nov. 16, 1966.)

1966
November

onstration, docked maneuvering for a high-apogee excursion, docking practice, systems tests, and Gemini Agena target vehicle (GATV) parking. The high-apogee excursion was not attempted because an anomaly was noted in the GATV primary propulsion system during insertion, and parking was not attempted because the GATV's attitude control gas was depleted. All other objectives were achieved. Nine spacecraft maneuvers effected rendezvous with the GATV. The onboard radar malfunctioned before the terminal phase initiate maneuver, but the crew used onboard backup procedures to calculate the maneuvers. Rendezvous was achieved at 3 hours 46 minutes ground elapsed time, docking 28 minutes later. Two phasing maneuvers, using the GATV secondary propulsion system, were accomplished, but the primary propulsion system was not used. The first of two periods of standup EVA began at 19 hours 29 minutes into the

flight and lasted for 2 hours 29 minutes. During a more than two-hour umbilical EVA which began at 42 hours 48 minutes, Aldrin attached a 100-foot tether from the GATV to the spacecraft docking bar. He spent part of the period at the spacecraft adapter, evaluating various restraint systems and performing various basic tasks. The second standup EVA lasted 55 minutes, ending at 67 hours 1 minute ground elapsed time. The tether evaluation began at 47 hours 23 minutes after liftoff, with the crew undocking from the GATV. The tether tended to remain slack, although the crew believed that the two vehicles did slowly attain gravity-gradient stabilization. The crew jettisoned the docking bar and released the tether at 51 hours 51 minutes. Several spacecraft systems suffered problems during the flight. Two fuel cell stacks failed and had to be shut down, while two others experienced significant loss of power. At 39 hours 30 minutes ground elapsed time, the crew reported that little or no thrust was available from two orbit attitude and maneuver thrusters. Retrofire occurred 94 hours after liftoff. Reentry was automatically controlled. The spacecraft landed less than three miles from the planned landing point at 2:21 p.m., November 15. The crew was picked up by helicopter and deposited 28 minutes later on the deck of the prime recovery ship, the aircraft carrier *Wasp*. The spacecraft was recovered 67 minutes after landing.

1966
November

Mission Report for GT-XII, pp. 1-1 to 1-4, 2-1, 2-2, 4-1 to 4-7; Fact Sheet 291-I, *Gemini XII Flight and Gemini Program Summary*, December 1966; McDonnell *Final Report*, pp. 84-85.

Manned Spacecraft Center's (MSC) Gemini Program Office was abolished. The responsibility and authority for final Gemini activities, such as disposing of equipment and settling contract costs, were assigned to George F. MacDougall, Jr., the newly appointed Special Assistant for Gemini in MSC's Office of the Director of Administration. Wrapping up the program would require several years of gradually decreasing effort.

1967
February
1

MSC Announcement No. 67-15, Feb. 1, 1967; MacDougall interview.

A Gemini Summary Conference was held at Manned Spacecraft Center. Major focus of the 22 papers which followed the welcoming address by Director Robert R. Gilruth was on the results of the final Gemini missions. Sessions were devoted to orbital rendezvous and docking operations, extravehicular activities, operational experience, and the results of experiments carried aboard the Gemini missions.

1-2

Program, Gemini Summary Conference, MSC Auditorium, Houston, Tex., February 1967; *Gemini Summary Conference*, NASA SP-138, Feb. 1-2, 1967, *passim*.

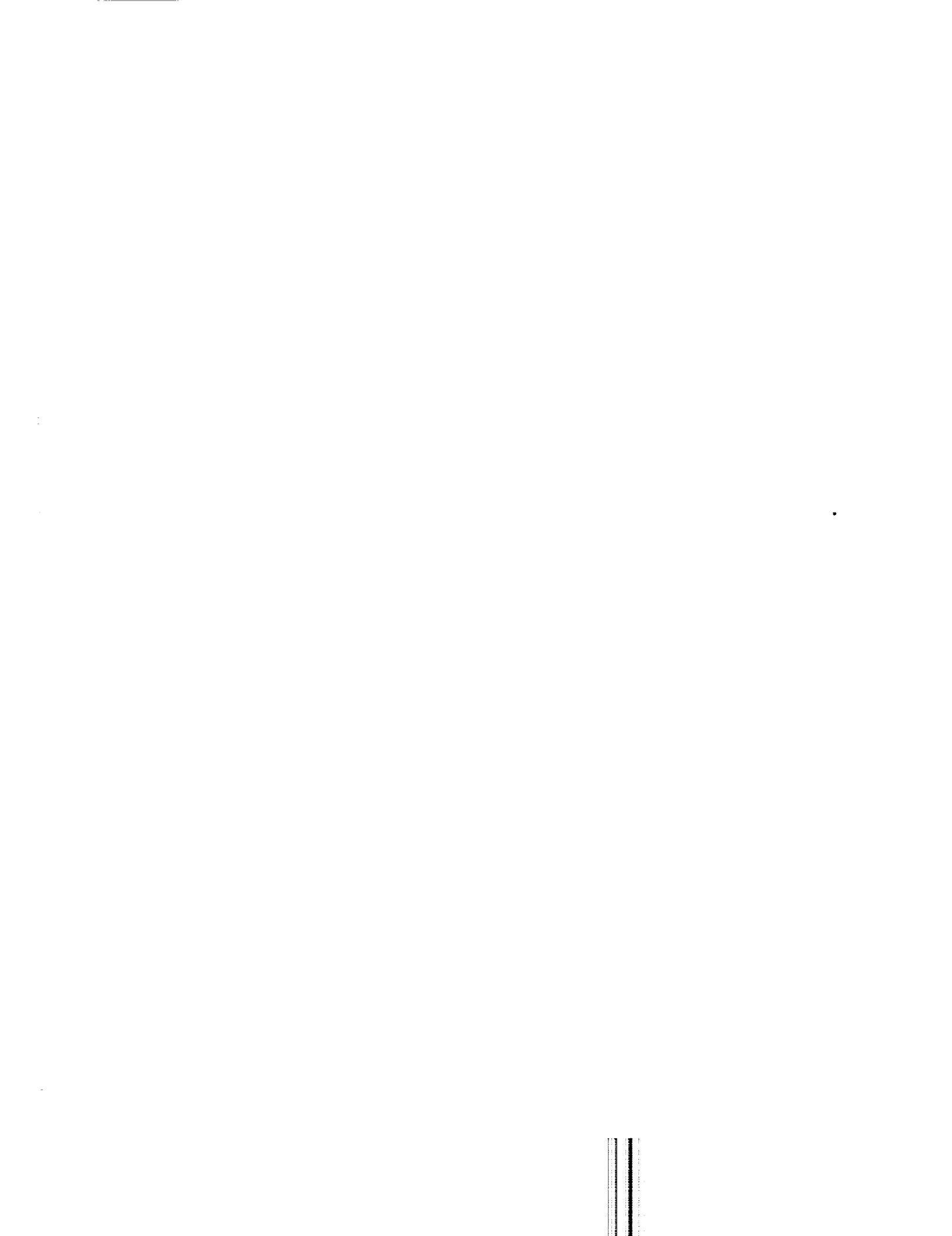

APPENDIXES

APPENDIX 1—GEMINI PROGRAM

Table A—General

Item	Mission				
	I	II	III	IV	V
GEMINI SPACE VEHICLE					
Spacecraft No.	1	2	3	4	5
Launch weight (lb.)	7026	6882	7111	7879	7947
Launch vehicle	GLV-1	GLV-2	GLV-3	GLV-4	GLV-5
Flight crew					
Command pilot	Unmanned	Unmanned	Grissom	McDivitt	Cooper
Pilot			Young	White	Conrad
Backup crew					
Command pilot			Schirra	Borman	Armstrong
Pilot			Stafford	Lovell	See
Launch date	Apr. 8, 1964	Jan. 19, 1965	Mar. 23, 1965	June 3, 1965	Aug. 21, 1965
Time (e.s.t.)	11:00:01 a.m.	9:03:59 a.m.	9:24:00 a.m.	10:15:59 a.m.	8:59:59 a.m.
Launch azimuth	72°	105°	72°	72°	72°
ORBITAL PARAMETERS					
At insertion					
Apogee (n.m.)	173.0	92.4***	121.0	152.2	188.9
Perigee (n.m.)	86.6		87.0	87.6	87.4
Period (min.)	89.3		88.3	88.90	89.59
Inclination angle	32.59°		32.6°	32.53°	32.59°
At retrofire					
Revolution			3	62	120
Apogee (n.m.)				136.5	154.8
Perigee (n.m.)				86.1	106.0
Period (min.)				88.53	89.32
Inclination angle				32.53°	32.61°
Highest apogee (n.m.)			121.0	159.9	188.9
Lowest perigee (n.m.)			85.6	86.1	87.4
G.E.T. to OAMS preretro (hr; min; sec)			4:21:23	97:28:02	
RETROFIRE & REENTRY					
Orbits to retrofire	None	Suborbital	3.1	66.1	127.7
G.E.T. to retrofire (hr; min; sec)		00:06:54	4:33:23	97:40:01	190:27:43
G.E.T. to touchdown (hr; min; sec)		00:18:16	4:52:31	97:56:12	190:55:14
Landing coordinates					
Lat.		16°36' N	22°26' N	27°44' N	29°44' N
Long.		49°46' W	70°51' W	74°11' W	69°45' W
Landing accuracy (n.m. from planned landing point)			60	44	91
RECOVERY					
Area		Mid-Atlantic	W/Atlantic	W/Atlantic	W/Atlantic
Status		Primary	Primary	Primary	Primary
Ship, U.S.S.		Lake Champlain.	Intrepid	Wasp	Lake Champlain.
Date		Jan. 19, 1965	Mar. 23, 1965	June 7, 1965	Aug. 29, 1965
Time (e.s.t.)					
Crew			3:28 p.m.	1:09 p.m.	9:26 a.m.
Spacecraft		10:52 a.m.	5:03 p.m.	2:28 p.m.	11:50 a.m.

*Mission 6 scrubbed; Mission 9 scrubbed.

**Stafford and Cernan, backup crew for Gemini 9, became prime crew.

***Apogee only (suborbital).

FLIGHT SUMMARY DATA

Mission—Continued						
VI-A*	VII	VIII	IX-A*	X	XI	XII
6	7	8	9	10	11	12.
7817	8076	8351	8268	8295	8374	8296.
GLV-6	GLV-7	GLV-8	GLV-9	GLV-10	GLV-11	GLV-12.
Schirra	Borman	Armstrong	Stafford**	Young	Conrad	Lovell.
Stafford	Lovell	Scott	Cernan**	Collins	Gordon	Aldrin.
Grissom	White	Conrad	Lovell	Bean	Armstrong	Cooper.
Young	Collins	Gordon	Aldrin	Williams	Anders	Cernan.
Dec. 15, 1965	Dec. 4, 1965	Mar. 16, 1966	June 3, 1966	July 18, 1966	Sept. 12, 1966	Nov. 1, 1966.
8:37:26 a.m.	2:30:03 p.m.	11:41:02 a.m.	8:39:33 a.m.	5:20:26 p.m.	9:42:26 a.m.	3:46:33 p.m.
81.4°	83.6°	99.9°	87.4°	98.8°	99.9°	100.6°.
140.0	177.1	146.7	144.0	145.1	150.6	146.1.
86.9	87.2	86.3	85.7	86.3	86.6	86.8.
87.92	89.39	88.83	88.78	88.79	88.99	88.87.
28.97°	28.89°	29.07°	28.91°	28.87°	28.85°	28.87°.
16	206	7	45	43	44	59.
168.1	163.6	161.3	155.5	215.5	163.0	155.0.
153.0	156.5	157.5	143.8	157.9	151.0	140.8.
90.54	90.57	90.55	90.19	91.48	90.38	90.06.
28.89°	28.89°	29.02°	28.91°	28.87°	28.84°	28.87°.
168.1	177.1	161.3	168.2	412.2	739.2	162.7.
86.9	87.2	86.3	85.7	86.3	86.6	86.8.
16.8	219.7	6.7	47.6	45.5	47.1	62.3.
25:15:58	329:58:04	10:04:47	71:46:44	70:10:24	70:41:36	93:59:58.
25:51:24	330:35:01	10:41:26	72:20:50	70:46:39	71:17:08	94:34:31.
23°35' N	25°25'01'' N	25°13'08'' N	27°52' N	26°44'07'' N	24°15'04'' N	24°35' N.
67°50' W	70°06'07'' W	136° E	75°00'04'' W	71°57' W	70° W	69°57' W.
7	6.4	1.1	0.38	3.4	2.65	2.6.
W/Atlantic	W/Atlantic	W/Pacific	W/Atlantic	W/Atlantic	W/Atlantic	W/Atlantic.
17-1	207-1	7-3	46-1	44-1	45-1	60-1A.
Primary	Primary	Secondary	Primary	Primary	Primary	Primary.
Wasp	Wasp	Mason	Wasp	Guadalcanal	Guam	Wasp.
Dec. 16, 1965	Dec. 18, 1965	Mar. 17, 1966	June 6, 1966	July 21, 1966	Sept. 15, 1966	Nov. 15, 1966.
11:32 a.m.	9:37 a.m.	1:28 a.m.	9:53 a.m.	4:34 p.m.	9:23 a.m.	2:49 p.m.
11:32 a.m.	10:08 a.m.	1:37 a.m.	9:53 a.m.	5:01 p.m.	9:58 a.m.	3:28 p.m.

Table B—Orbital Operations

Mis- sion	Target Vehicle	Target Launch Vehicle	Launch			Type of Activity	Revolu- tion
			Date	Time (e.s.t.)	Azimuth (deg.)		
VI	GATV- 5002	TLV- 5301	Oct. 25, 1965	10:00:04.490 a.m.--	85. 7	GATV failed to achieve orbit.	-----
VI-A	S/C 7 (See Table A)	-----	-----	-----	-----	Coelliptical rendezvous... Station keeping.....	4 -----
VIII	GATV- 5003	TLV- 5302	Mar. 16, 1966	10:00:03.127 a.m.--	84. 4	Coelliptical rendezvous... Docking.....	4 4
IX	GATV- 5004	TLV- 5303	May 17, 1966	10:15:03.422 a.m.--	83. 9	GATV failed to achieve orbit.	-----
IX-A	ATDA... -----	TLV 5304	June 1, 1966	10:00:02.363 a.m.--	83. 8	Coelliptical rendezvous... Station keeping..... Equi-period rendezvous... Station keeping..... Rendezvous from above... Station keeping.....	3 ----- 4 ----- 12 to 15 -----
X	GATV- 5005	TLV- 5305	July 18, 1966	3:39:46.131 p.m.--	83. 9	Coelliptical rendezvous... Docking..... High-altitude excursion... Rerendezvous.....	4 4 12 29
XI	GATV- 5006	TLV- 5306	Sept. 12, 1966	8:05:01.725 a.m.--	83. 32	Rendezvous at first apogee. Docking..... High-altitude excursion... Tethered operations..... Coincident orbit rendezvous.	1 1 26 32 42
XII	GATV- 5001	TLV- 5307	Nov. 11, 1966	2:07:58.688 a.m.--	83. 3	Coelliptical rendezvous... Docking..... Tethered operations.....	3 3 30 to 33

APPENDIX 1

Spacecraft Orbital Parameters				Ground Elapsed Time		Orbital Parameters After Activity			
Apogee (n.m.)	Perigee (n.m.)	Period (min.)	Inclination angle (deg.)	To begin (hr:min:sec)	Period (hr:min:sec)	Apogee (n.m.)	Perigee (n.m.)	Period (min.)	Inclination angle (deg.)
161.9	156.3	90.55	28.89	5:56:00	5:17:29				
				6:33:22	0:41:50	161.1	158.6	90.55	29.02
148.0	145.2	90.07	28.91	4:15:00	0:46:00				
163.3	156.6	90.49	28.89	6:36:00	0:39:00				
168.2	166.4	90.81	28.91	21:42:00	1:17:00	160.3	156.8	90.51	28.91
145.8	143.3	89.88	28.85	5:52:37	38:47:00	161.9	156.5	90.56	28.85
412.2	158.5	95.31	28.88						
209.2	205.9	92.38	28.90			216.0	213.5	92.63	28.91
						163.1	153.7	90.55	28.85
				1:34:16	48:20:44				
739.2	156.3	101.52	28.85						
164.0	152.6	90.45	28.83	49:55:00	3:03:00	164.0	155.6	90.45	28.83
151.7	146.8	90.11	28.88	4:13:53	43:09:24	162.7	156.4	90.50	28.87
159.0	140.3	90.14	28.88	47:23:17	4:27:40				

Table C—Project Gemini Experiments

Experiment	Mission										
	III	IV	V	VI	VII	VIII	IX	X	XI	XII	
M-1 Cardiovascular conditioning			x+		x+						
M-3 Inflight exerciser		x+	x+		x+						
M-4 Inflight phonocardiogram		x+	x+		x+						
M-5 Bio-assays body fluids		x+			x+	x ⁻¹	x+				
M-6 Bone demineralization			x+		x+						
M-7 Calcium balance study					x+						
M-8 Inflight sleep analysis					x ^{-e}						
M-9 Human otolith function			x+		x+						
MSC-1 Electrostatic charge		x+	x+								
MSC-2 Proton electron spectrometer		x+			x ^{-f}						
MSC-3 Tri-axis magnetometer		x+			x+			x+		x+	
MSC-4 Optical communication					x ^{-g}						
MSC-5 Lunar UV spectral reflectance								xo ^z			
MSC-6 Beta spectrometer								x+		x ^{-a}	
MSC-7 Bremsstrahlung spectrometer								x+		x+	
MSC-8 Color patch photography								x+			
MSC-10 Two-color Earth's limb photography		x+									
MSC-12 Landmark contrast measurement					xo ^h			xo ^o			
T-1 Reentry communications	x+										
T-2 Manual navigation sightings										x+	
D-1 Basic object photography			x+								
D-2 Nearby object photography			xo ^o								
D-3 Mass determination						xo ^j				x+	
D-4 Celestial radiometry			x+		x+						
D-5 Star occultation navigation					xo ^b			x+			
D-6 Surface photography			x+								
D-7 Space object radiometry			x+		x+						
D-8 Radiation in spacecraft		x+		x+							
D-9 Simple navigation		xo ^b			x+						
D-10 Ion-sensing attitude control								x+		x+	
D-12 Astronaut maneuvering unit								x ⁻¹			
D-13 Astronaut visibility			xo ^d			x+					
D-14 UHF-VHF polarization						xo ^j	x ^{-m}				
D-15 Night image intensification						xo ^j				x+	
D-16 Power tool evaluation						xo ^j				xo ^q	
S-1 Zodiacal light photography			x+			xo ^j	x+	x+			
S-2 Sea urchin egg growth	x ⁻ⁿ										
S-3 Frog egg growth						x ^{-k}				x+	
S-4 Radiation and zero g on blood	x+									x+	
S-5 Synoptic terrain photography	x+	x+	x+	x+				x+	x+	x+	
S-6 Synoptic weather photography	x+	x+	x+	x+				x+	x+	x+	
S-7 Cloud top spectrometer			x+			xo ⁱ					
S-8 Visual acuity			x+		x+						
S-9 Nuclear emulsion						xo ^j				x+	
S-10 Agena micrometeorite collection						xo ^j	xo ⁿ	x+		x+	
S-11 Airglow horizon photography							x+		x ^{-r}	x+	
S-12 Micrometeorite collection							x+	xo ^p		x+	
S-13 UV astronomical camera								x+	x+	x ^{-t}	

APPENDIX 1

Experiment	Mission										
	III	IV	V	VI	VII	VIII	IX	X	XI	XII	
S-26 Ion wake measurement								x+	x+		
S-29 Librations region photography										x+	
S-51 Sodium vapor cloud										xo ^u	
S-30 Dim light photography/orthicon						xo ^j			x+		
S-64 Sunrise UV photography										xo ^v	
Eclipse photography										x- ^w	

- Malfunction of instrument handle terminated experiment.
- Time hacks not entered on telemetry; positions thus not computable.
- Precluded because rendezvous with rendezvous evaluation pod not accomplished.
- Weather obscuration and spacecraft attitude restrictions.
- Accidental removal of all electrodes by command pilot at 55:10 hrs G.E.T.
- Intermittent failure of experimental equipment.
- Cloud obscuration and spacecraft attitude restrictions.
- Tube failure in D-5 photometer.
- Only limited number of samples collected because of early termination of mission.
- Precluded by early termination of mission.
- Half of inflight part of experiment not performed because of early termination of mission.
- AMU evaluation terminated because of astronaut's visor fogging.
- Insufficient number of data samples drawn.
- Data not collected because spacecraft not near augmented target docking adapter during umbilical EVA.

- Deleted because of limitations on time and fuel supply.
- Collection apparatus retrieved but lost by floating out of spacecraft.
- EVA terminated after 33 minutes.
- No high-orbit photographs because of fault in camera magazine.
- Experimental equipment failed 5 minutes after experiment began.
- Two-thirds of starfields excluded because of spacecraft/GATV lack of maneuverability.
- Camera shutter failure.
- Static electricity in camera fogged nearly all exposures.
- All still-camera film badly overexposed.
- Canceled because Moon was out of phase.

- Notes:
- x Indicates experiment planned (up to time of liftoff).
 - + Indicates experiment performed.
 - Indicates experiment only partially completed (with reason listed below).
 - o Indicates experiment could not be performed (with reason listed below).

PROJECT GEMINI: A CHRONOLOGY

Table D—Extravehicular Activity on Gemini Missions

Mission	Type	Ground Elapsed Time						
		Cabin pressure to zero (hr:min:sec)	Hatch opening (hr:min)	Crewman standing (hr:min)	Crewman outside (hr:min)	Crewman inside (hr:min)	Hatch closing (hr:min)	Cabin pressure off zero (hr:min:sec)
IV	Umbilical	4:17:36 (T)	4:18 (E)	4:20 (V)	4:30 (V)	4:50 (V)	4:54 (E)	4:56:51 (T)
IX-A	Umbilical	49:23:00 (V)	49:23 (V)	49:24 (V)	49:40 (V)	51:26 (V)	51:30 (V)	51:31:00 (V)
X	Standup	23:23:26 (T)	23:24 (V)	23:27 (V)	-----	-----	24:13 (V)	24:13:46 (T)
	Umbilical	48:40:48 (T)	48:41 (E)	48:42 (V)	48:47 (V)	49:12 (V)	49:20 (E)	49:20:56 (T)
	Equipment jettison	50:31:56 (T)	50:33 (E)	-----	-----	-----	50:34 (E)	50:34:48 (T)
XI	Umbilical	24:02:16 (T)	24:02 (V)	24:03 (V)	24:09 (V)	24:30 (E)*	24:35 (E)	24:36:10 (T)
	Equipment jettison	25:36:18 (T)	25:37 (V)	-----	-----	-----	25:39 (V)	25:39:45 (T)
	Standup	46:06:11 (T)	46:07 (E)	n/a	-----	-----	48:15 (V)	48:16:04 (T)
XII	Standup I	19:25:43 (T)	19:29 (V)	19:30 (V)	-----	-----	21:58 (E)	21:58:30 (T)
	Umbilical	42:47:31 (T)	42:48 (V)	42:51 (V)	42:52 (V)	44:47 (V)	44:54 (V)	44:56:08 (T)
	Standup II	66:05:24 (T)	66:06 (E)	66:08 (V)	-----	-----	67:01 (V)	67:03:03 (T)

*Estimated from comment on tape that the pilot rested for about five minutes.

Notes:

- (T) obtained from telemeter cabin pressure data.
(V) obtained from voice transcriptions (air-ground and onboard recorded).
(E) estimated from above two items.

APPENDIX 2—GEMINI PROGRAM AND MISSION OBJECTIVES

General

The general objectives of the Gemini program are to develop further operational capability in space and to investigate the problems of working and living in space. The Gemini program consists primarily of development flights, long-duration flights, and rendezvous-development flights. The National Aeronautics and Space Administration assigned certain specific objectives to the Gemini program. These objectives were as follows:

- (1) Subject two men and their supporting equipment to long-duration flights of up to two weeks in space
- (2) Achieve rendezvous and docking with another orbiting vehicle and develop efficient and reliable rendezvous techniques
- (3) Using the target vehicle propulsion system, maneuver the spacecraft in space after docking
- (4) Perform extravehicular activities requiring one of the flight crew to climb out of the spacecraft for short periods of time while in orbit and develop the capability and techniques for extravehicular operations in free space
- (5) Provide a controlled reentry whereby the spacecraft is brought to a specific landing area
- (6) Provide training for the flight crew members who will fly in the Apollo program
- (7) Perform appropriate engineering and scientific experiments in support of the national space program

Mission

Gemini I

Primary Objectives:

- (1) To demonstrate the Gemini launch vehicle performance and to flight-qualify the vehicle subsystems for future Gemini missions (achieved)
- (2) To determine the exit heating conditions on the spacecraft and launch vehicle (achieved)
- (3) To demonstrate the structural integrity and compatibility of the spacecraft and launch vehicle combination through orbital insertion (achieved)
- (4) To demonstrate the structural integrity of the Gemini spacecraft from launch through orbital insertion (achieved)
- (5) To demonstrate the ability of the Gemini launch vehicle and ground guidance systems to achieve the required orbital insertion conditions (achieved)
- (6) To monitor the switchover circuits as installed on the Gemini launch vehicle and to evaluate their sufficiency for mission requirements (achieved)
- (7) To demonstrate the malfunction detection system (achieved)

Secondary Objectives:

- (1) To evaluate the operational procedures used in establishing the Gemini launch vehicle trajectory and cutoff conditions (achieved)
- (2) To verify orbital insertion conditions by tracking the C-band transponder system in the spacecraft (achieved)
- (3) To demonstrate the performance of the launch and tracking networks (achieved)
- (4) To provide training for the flight dynamics, guidance switchover, and malfunction detection systems flight controllers (achieved)
- (5) To demonstrate the operational capability of the prelaunch and launch facilities (achieved)

Gemini II

Primary Objectives:

- (1) To demonstrate the adequacy of the reentry assembly heat protection equipment during a maximum-heating-rate reentry (achieved)
- (2) To demonstrate the structural integrity and capability of the spacecraft from liftoff through landing (achieved)

PROJECT GEMINI: A CHRONOLOGY

- (3) To demonstrate satisfactory performance of the spacecraft systems (achieved)
- (4) To demonstrate systems checkout and launch procedures (achieved)
- (5) To evaluate backup guidance steering signals throughout launch (achieved)

Secondary Objectives:

- (1) To obtain test results on the cryogenics, fuel cell and reactant supply, and communications systems (achieved with the exception of the fuel cell results—the fuel cell was deactivated before liftoff because of a malfunction)
- (2) To further flight-qualify the launch vehicle and to demonstrate its ability to insert the spacecraft into a prescribed trajectory (achieved)
- (3) To demonstrate the compatibility of the launch vehicle and spacecraft through the countdown and launch sequence (achieved)
- (4) To provide training for flight controllers (achieved)
- (5) To further qualify ground communications and tracking systems in support of future manned missions (achieved)

Gemini III

Primary Objectives:

- (1) To demonstrate manned orbital flight in the Gemini spacecraft and to further qualify the spacecraft and launch vehicle systems for future manned missions (achieved)
- (2) To evaluate the two-man Gemini design and its effects on flight crew performance (achieved)
- (3) To demonstrate and evaluate the operation of the worldwide tracking network with the spacecraft and flight crew (achieved)
- (4) To demonstrate and evaluate the capability to maneuver the spacecraft in orbit using the orbit attitude and maneuver system (OAMS) (achieved)
- (5) To demonstrate the OAMS capability to perform retrofire backup (achieved)
- (6) To demonstrate the capability to control the reentry flight path and the ultimate landing point (partially achieved. The accuracy of the controlled landing point was not as high as had been expected)
- (7) To evaluate the performance of the spacecraft systems (achieved)
- (8) To demonstrate systems checkout, prelaunch, and launch procedures for a manned spacecraft with a two-man crew (achieved)
- (9) To recover the spacecraft and evaluate the recovery system (achieved)

Secondary Objectives:

- (1) To evaluate the flight crew equipment, biomedical instrumentation, and partial personal hygiene system (achieved)
- (2) To perform three experiments (partially achieved)
- (3) To evaluate the effects of the low-level longitudinal oscillations (POGO) of the launch vehicle on the flight crew (achieved)
- (4) To obtain general photographic coverage in orbit (partially achieved because of an improper lens on the 16mm camera)

Gemini IV

Primary Objectives:

- (1) To evaluate the effects of prolonged exposure of the two-man flight crew to the space environment (achieved)
- (2) To demonstrate and evaluate the performance of the Gemini spacecraft systems for a period of approximately four days in the space environment (partially achieved. The computer-controlled reentry was not flown because of an inadvertent alteration of the computer memory)
- (3) To evaluate previously developed procedures for crew rest and work cycles, eating schedules, and real-time flight planning for long-duration flights (achieved)

Secondary Objectives:

- (1) To demonstrate extravehicular activity in space and to evaluate attitude and position control using the hand-held propulsion unit or the tether line (achieved)
- (2) To conduct stationkeeping and rendezvous maneuvers with the expended second stage of the launch vehicle (partially achieved. Separation and rendezvous

APPENDIX 2

were not attempted because the OAMS propellants allocated for this maneuver were consumed during stationkeeping immediately after insertion)

- (3) To conduct further evaluation of the spacecraft systems as outlined in the inflight systems test objectives (achieved)
- (4) To demonstrate the capability of the spacecraft and flight crew to make significant in-plane and out-of-plane maneuvers (achieved)
- (5) To demonstrate OAMS capability to operate as a backup for the retrograde rocket system (achieved)
- (6) To conduct 11 experiments (achieved)

Gemini V

Primary Objectives:

- (1) To evaluate the performance of the rendezvous guidance and navigation system using a rendezvous evaluation pod (REP) (not achieved. Rendezvous with the REP was not conducted because of a decision to power down the spacecraft)
- (2) To demonstrate manned orbital flight in the Gemini spacecraft for approximately eight days (achieved)
- (3) To evaluate the effects of exposing the two-man crew to long periods of weightlessness (achieved)

Secondary Objectives:

- (1) To demonstrate controlled reentry guidance to a predetermined landing point (not achieved. Incorrect navigation coordinates transmitted to the spacecraft computer from the ground network caused an 89-mile undershoot)
- (2) To evaluate the performance of the fuel cell under flight electrical load conditions (achieved)
- (3) To demonstrate all phases of guidance and control system operation necessary to support a rendezvous mission (achieved)
- (4) To evaluate the capability of either pilot to maneuver the spacecraft in orbit to a close proximity with another object (not achieved)
- (5) To evaluate the performance of the rendezvous radar (achieved)
- (6) To conduct 17 experiments (partially achieved. One photography experiment was not conducted because of the decision to cancel rendezvous with the REP)

Gemini VI

Primary Objective:

To demonstrate rendezvous and docking with the Gemini-Agena target vehicle, using both the spacecraft and Agena capabilities as required (not achieved. The Gemini-Agena target vehicle (GATV) failed to attain orbital conditions, causing the mission to be terminated before Gemini spacecraft launch)

Secondary Objectives:

- (1) To conduct rendezvous and docking using radar computer closed-loop mode
- (2) To conduct multiple dockings under various lighting conditions (day and night—both pilots)
- (3) To demonstrate reentry guidance capability and landing point control
- (4) To evaluate spacecraft command of the GATV in undocked mode
- (5) To determine useful lifetime and ground control capability of the GATV
- (6) To evaluate visibility of the GATV under various conditions of lighting and range
- (7) To provide motion picture documentation of the GATV during docking
- (8) To conduct systems tests and execute inflight experiments

Gemini VI-A

Primary Objective:

To rendezvous with the *Gemini VII* spacecraft in orbit (achieved)

Secondary Objectives:

- (1) To perform closed-loop rendezvous at the fourth darkness (achieved)
- (2) To conduct stationkeeping with the *Gemini VII* spacecraft (achieved)
- (3) To evaluate the reentry guidance capability of the spacecraft (achieved)
- (4) To conduct visibility tests of the *Gemini VII* spacecraft as a rendezvous target vehicle (achieved)

PROJECT GEMINI: A CHRONOLOGY

- (5) To conduct four assigned experiments (partially achieved. A radiation experiment was not complete)
- (6) To conduct spacecraft system tests (achieved)

Gemini VII

Primary Objectives:

- (1) To demonstrate the capability of the spacecraft and crew on a 14-day mission (achieved)
- (2) To evaluate the effects of the 14-day flight on the crew (achieved)

Secondary Objectives:

- (1) To provide a rendezvous target for the *Gemini VI-A* spacecraft (achieved)
- (2) To conduct stationkeeping with *Gemini VI-A* (achieved)
- (3) To conduct stationkeeping with the second stage of the launch vehicle (achieved)
- (4) To conduct 20 scheduled experiments (achieved)
- (5) To evaluate a lightweight pressure suit during a mission (achieved)
- (6) To evaluate the spacecraft reentry guidance capability (achieved)
- (7) To conduct spacecraft systems tests (achieved)

Gemini VIII

Primary Objectives:

- (1) To perform rendezvous and docking with the GATV (achieved)
- (2) To conduct extravehicular activities (not achieved. Mission was terminated early because of a malfunctioning thruster in the spacecraft)

Secondary Objectives:

- (1) To perform rendezvous and docking during the fourth revolution (achieved)
- (2) To perform docked-vehicle maneuvers using the GATV's secondary propulsion system (not achieved)
- (3) To conduct systems evaluation (partially achieved)
- (4) To conduct 10 experiments (partially achieved)
- (5) To practice docking (not achieved)
- (6) To perform a rerendezvous (not achieved)
- (7) To evaluate the auxiliary tape memory unit (achieved)
- (8) To park the GATV in a 220-nautical-mile circular orbit (achieved)

Gemini IX

Primary Objectives:

- (1) To rendezvous and dock with the GATV (not achieved. The Atlas target launch vehicle failed to boost the GATV into orbit, and the mission was terminated before the launch of the Gemini spacecraft)
- (2) To conduct extravehicular activities

Secondary Objectives:

- (1) To rendezvous and dock with the Agena during the third revolution of the Gemini spacecraft
- (2) To conduct systems tests
- (3) To conduct eight inflight experiments
- (4) To conduct docking practice with the Agena
- (5) To evaluate line-of-sight docked vehicle control
- (6) To conduct rerendezvous exercises to provide additional crew experience and to perform rendezvous from above
- (7) To conduct a phantom rendezvous using the spacecraft docked with the Agena to demonstrate ability to perform midcourse maneuvers in the docked configuration
- (8) To evaluate onboard navigation capability
- (9) To park the Agena

Gemini IX-A

Primary Objectives:

- (1) To perform rendezvous and docking with the augmented target docking adapter (ATDA) (partially achieved. The spacecraft could not dock because

the ascent shroud had not jettisoned from the ATDA)

- (2) To conduct extravehicular activities (achieved)

Secondary Objectives:

- (1) To perform rendezvous during the third revolution (achieved)
- (2) To conduct systems evaluation (achieved)
- (3) To perform equiperiod rendezvous (achieved)
- (4) To conduct seven experiments (partially achieved. A meteoroid collection experiment could not be completed because the extravehicular activity did not take place near the target vehicle)
- (5) To conduct docking practice (not achieved)
- (6) To perform rendezvous from above (achieved)
- (7) To demonstrate a controlled reentry (achieved)

Gemini X

Primary Objective:

To perform rendezvous and docking with the GATV (achieved)

Secondary Objectives:

- (1) To rendezvous and dock in the fourth revolution in check of onboard navigation (achieved)
- (2) To use large propulsion systems in space in dual rendezvous using the target vehicle primary and secondary propulsion systems (achieved)
- (3) To conduct extravehicular activities (achieved)
- (4) To conduct docking practice (not attempted because of insufficient fuel reserves)
- (5) To perform 14 experiments (partially achieved. Some experiments were not conducted because of time limitations and a constraint on the use of spacecraft propellants)
- (6) To conduct systems evaluations (achieved)

Gemini XI

Primary Objective:

To rendezvous and dock with the target vehicle during the first revolution (achieved)

Secondary Objectives:

- (1) To conduct docking practice (achieved)
- (2) To perform extravehicular activity (achieved)
- (3) To conduct 11 experiments (partially achieved. One photography experiment was not completed because extravehicular activity was terminated earlier than planned)
- (4) To maneuver in the docked configuration, including a high-apogee excursion (achieved)
- (5) To conduct a tethered-vehicle test (achieved)
- (6) To demonstrate an automatic reentry (achieved)
- (7) To park the Agena target vehicle (achieved)

Gemini XII

Primary Objectives:

- (1) To rendezvous and dock with a target vehicle (achieved)
- (2) To conduct extravehicular activity at least three times during the mission (achieved)

Secondary Objectives:

- (1) To practice docking (achieved)
- (2) To accomplish a tethered stationkeeping exercise, using the gravity gradient technique (achieved)
- (3) To conduct 15 experiments (achieved)
- (4) To perform maneuvers, using the Agena primary propulsion system to change orbit (not achieved. Ground controllers noted a fluctuation in the Agena propulsion system and canceled the maneuver.)
- (5) To use a controlled reentry technique as demonstrated on *Gemini XI* (achieved)

PROJECT GEMINI: A CHRONOLOGY

Definitions

1. The term "demonstrate" means the occurrence of an action or event during the mission. Accomplishing this type of objective requires a qualitative answer derived through the relation of the action or event to some other known information or occurrence.

2. The term "determine" means to perform investigations which will indicate to what extent a unit is operating as designed. The applicable information is generally obtained from instrumentation which measures basic inputs and outputs of the unit or system.

3. The term "evaluate" means the measuring of the performance of a unit or system, as well as the performance and/or interaction of its sections or subsystems that are under investigation. Accomplishment of this type of objective requires quantitative data on the performance of the unit or system and its sections or subsystems.

SOURCE: MSC-G-R-66-5, "Gemini Program Flight Summary Report," with revisions, January 1967; NASA Program Gemini Working Paper No. 5039, "Gemini Program/Mission Directive," Nov. 19, 1965, with Appendixes A through C.

APPENDIX 3—VEHICLE MANUFACTURING AND TESTING HISTORIES

Table A—Gemini Launch Vehicle

[From Aerospace, *Gemini Program Launch Systems Final Report*, Sections II.F and II.G,
and Martin, *Gemini-Titan II Air Force Launch Vehicle Press Handbook*, Appendix D.]

Item	Gemini Titan Launch Vehicle					
	GLV-1	GLV-2	GLV-3	GLV-4	GLV-5	GLV-6
Major welding of propellant tanks at Denver began.	Sept. 1962	Sept. 1962	June 1963	Nov. 1963	Jan. 1964	Apr. 1964
Propellant tanks delivered to Baltimore.	Oct. 10, 1962	July 12, 1963	Dec. 13, 1963	Mar. 6, 1964	June 25, 1964	Aug. 16, 1964
Assembly completed.	May 21, 1963	Jan. 9, 1964	June 6, 1964	Sept. 4, 1964	Dec. 9, 1964	Feb. 25, 1965
Horizontal tests completed.	May 27, 1963	Jan. 17, 1964 ^a	June 17, 1964	Oct. 23, 1964	Jan. 7, 1965	Apr. 3, 1965
Erected in vertical test facility.	June 9, 1963	Feb. 7, 1964	June 22, 1964	Oct. 28, 1964	Feb. 8, 1965	Apr. 15, 1965
Power applied.		Feb. 20, 1964		Nov. 4, 1964	Feb. 15, 1965	May 13, 1965
Subsystems Function Verification Tests completed.			July 31, 1964 ^a	Nov. 19, 1964	Mar. 8, 1965	June 22, 1965
Combined Systems Acceptance Test completed.	Oct. 4, 1963 ^a	Apr. 22, 1964	Sept. 30, 1964 ^b	Nov. 25, 1964	Apr. 21, 1965	June 25, 1965
Vehicle Acceptance Team inspection.	Oct. 8, 1963 ^a	Apr. 27, 1964	Oct. 7, 1964 ^b	Dec. 11, 1964 ^a	Apr. 26, 1965	July 7, 1965
DD-250.	Oct. 12, 1963	June 22, 1964	Nov. 18, 1964	Mar. 21, 1965	May 15, 1965	July 31, 1965
Delivered to ETR.	Oct. 26, 1963	July 11, 1964	Jan. 23, 1965 ¹	Mar. 23, 1965	May 18, 1965	Aug. 2, 1965
Erection at complex 19 completed.	Oct. 29, 1963	Sept. 14, 1964 ^c	Jan. 25, 1965	Mar. 29, 1965	June 7, 1965	Aug. 31, 1965
Power applied.	Nov. 13, 1963		Jan. 29, 1965			Dec. 5, 1965
Subsystem and Combined Systems tests completed.	Jan. 21, 1964 ¹	Oct. 20, 1964	Feb. 15, 1965	Apr. 16, 1965	June 29, 1965	Sept. 16, 1965
Tanking exercise						
Spacecraft mated to GLV.	Mar. 5, 1964	Nov. 5, 1964	Feb. 17, 1965	Apr. 23, 1965	July 7, 1965	Sept. 17, 1965
Joint Combined Systems Tests						Dec. 5, 1965
Countdown practice exercises completed—Wet Mock Simulated Launch.	Apr. 2, 1964	Nov. 24, 1964	Mar. 8, 1965	May 13, 1965	July 22, 1965	Oct. 7, 1965
Final Status Simulated Flight Test.	Apr. 5, 1964	Jan. 14, 1965 ^d	Mar. 17, 1965	May 29, 1965	Aug. 12, 1965	Oct. 19, 1965
Launch	Apr. 8, 1964	Jan. 19, 1965 ^d	Mar. 23, 1965	June 3, 1965	Aug. 21, 1965	Oct. 25, 1965 ^e
						Dec. 15, 1965 ^f

PROJECT GEMINI: A CHRONOLOGY

Item	Gemini Titan Launch Vehicle					
	GLV-7	GLV-8	GLV-9	GLV-10	GLV-11	GLV-12
Major welding of propellant tanks at Denver began.	May 1964	Sept. 1964	Feb. 1965	Apr. 1965	June 28, 1965	Nov. 22, 1965
Propellant tanks delivered to Baltimore.	Feb. 25, 1965	Apr. 15, 1965	Aug. 16, 1965	Sept. 21, 1965	Nov. 3, 1965	Jan. 20, 1966
Assembly completed	May 20, 1965	Nov. 10, 1965	Nov. 10, 1965	Feb. 28, 1966	Apr. 5, 1966	June 1, 1966
Horizontal tests completed	June 14, 1965	Sept. 15, 1965	Nov. 23, 1965	Mar. 3, 1966	Apr. 25, 1966	June 14, 1966
Erected in vertical test facility	June 28, 1965	Sept. 28, 1965	Dec. 10, 1965	Mar. 7, 1966	Apr. 29, 1966	June 22, 1966
Power applied	July 26, 1965	Oct. 13, 1965	Dec. 22, 1965	Mar. 14, 1966	May 9, 1966	July 6, 1966
Subsystem Functional Verification Tests completed.	Aug. 25, 1965	Nov. 4, 1965	Jan. 20, 1966	Apr. 13, 1966	June 8, 1966	July 11, 1966
Combined Systems Acceptance Test completed.	Sept. 20, 1965	Nov. 8, 1965	Feb. 9, 1966	Apr. 14, 1966	June 9, 1966	July 29, 1966
Vehicle Acceptance Team inspection.	Sept. 28, 1965	Nov. 16, 1965	Feb. 15, 1966	Apr. 26, 1966	June 20, 1966	Aug. 9, 1966
DD-250	Oct. 15, 1965	Dec. 23, 1965	Mar. 8, 1966	May 18, 1966		
Delivered to ETR	Oct. 19, 1965	Jan. 6, 1966	Mar. 10, 1966	May 20, 1966	July 12, 1966	Sept. 3, 1966
Erection at complex 19 completed.	Oct. 29, 1965	Jan. 13, 1966	Mar. 24, 1966	June 8, 1966	July 22, 1966	Sept. 16, 1966
Power applied	Oct. 31, 1965	Jan. 19, 1966	Mar. 30, 1966	June 9, 1966	July 27, 1966	Sept. 19, 1966
Subsystem and Combined Systems Tests completed.	Nov. 12, 1965	Feb. 1, 1966	Apr. 12, 1966	June 17, 1966	Aug. 5, 1966	Oct. 10, 1966
Tanking exercise	Nov. 22, 1965	Feb. 18, 1966	Apr. 20, 1966	June 24, 1966	Aug. 15, 1966	Oct. 12, 1966
Spacecraft mated to GLV.	Nov. 22, 1965	Mar. 5, 1966	May 8, 1966	July 5, 1966	Aug. 24, 1966	Oct. 25, 1966
Countdown practice exercises completed—Wet Mock Simulated Launch.		Mar. 9, 1966	May 10, 1966	July 13, 1966	Aug. 31, 1966	Nov. 1, 1966
Final Status Simulated Flight Test.	Nov. 27, 1965	Mar. 10, 1966	May 11, 1966*	July 13, 1966	Sept. 1, 1966	Nov. 2, 1966
Launch.	Dec. 4, 1965	Mar. 16, 1966	June 3, 1966*	July 18, 1966	Sept. 12, 1966 ^b	Nov. 11, 1966. ¹

^a GLV-1 not accepted after first CSAT (Sept. 6, 1963) and VAT inspection (Sept. 11, 1963).
^b GLV-3 not accepted after first CSAT (Aug. 7, 1964) and VAT inspection (Aug. 17, 1964).
^c First erected July 16, 1964, and Subsystem tests began July 17, nullified by lightning strike Aug. 17. Hurricane Cleo caused stage II deerection Aug. 28; reerected Aug. 31. Hurricane Dora caused vehicle deerection Sept. 8.
^d After SFT on Dec. 3, 1964, launch scheduled for Dec. 9 aborted at ignition plus 1.7 sec.
^e Scrubbed because of Agena catastrophic failure.
^f Aborted Dec. 12, 1965, at ignition plus 1.16 sec when umbilical tailpung dropped prematurely. Investigation also revealed dust cover in gas generator.
^g Mission postponed May 17 when GATV failed to orbit. SFT repeated May 28. Mission again scrubbed on June 1 because of spacecraft computer problem.
^h Mission scrubbed Sept. 9 because pinhole discovered in oxidizer tank. Rescheduled for Sept. 10; scrubbed because of AGE oversensitivity.
ⁱ Mission postponed on Nov. 8 because of malfunction in secondary autopilot; postponed again on Nov. 9 for malfunction in new autopilot.
^j Sequence compatibility firing (SCF).
^k POGO kit installed Jan. 20-Feb. 5.
^l Modified at Baltimore after GT-2 tandem actuator trouble at the Cape—actuator replaced Jan. 8.
^m Delay from Dec. 19-Mar. 19, 1966, permitted modifications at Baltimore that were usually done at the Cape.

Table B—Gemini Target Vehicle

[From Aerospace, Gemini Program Launch Systems Final Report, Sections III.F and III.G]

Item	Stage Completed						
	5001	5002	5003	5004	5005	5006	5001R
Basic vehicle.....	Apr. 30, 1964	Dec. 17, 1964	July 20, 1965	Oct. 25, 1965	Feb. 2, 1966	Mar. 22, 1966	Nov. 23, 1965.*
Modification and final assembly.....							
Combined Systems Acceptance Test.	Sept. 24, 1964	May 18, 1965	Oct. 14, 1965	Jan. 26, 1966	Apr. 12, 1966	June 6, 1966	July 21, 1966.**
Vehicle Acceptance Team inspection.	May 6, 1965	June 30, 1965	Jan. 8, 1966	Feb. 27, 1966	May 3, 1966	June 27, 1966	Aug. 15, 1966.
Delivered to ETR.	May 27, 1965	July 23, 1965	Jan. 18, 1966	Mar. 11, 1966	May 14, 1966	July 13, 1966	Sept. 2, 1966.
Preliminary systems tests at Hangar E.	May 29, 1965	July 25, 1965	Jan. 21, 1966	Mar. 14, 1966	May 16, 1966	July 15, 1966	Sept. 4, 1966.
Interface tests, Plan X.	July 8, 1965	Aug. 23, 1965	Jan. 26, 1966	Mar. 21, 1966	June 1, 1966	July 21, 1966	Sept. 16, 1966.
Systems tests at Hangar E.							
Target and launch vehicles mated.	Sept. 1, 1965	Jan. 28, 1966	Jan. 28, 1966	Mar. 23, 1966	June 8, 1966	July 26, 1966	Sept. 20, 1966.
Systems tests at complex 14.	Sept. 30, 1965	Feb. 28, 1966	Feb. 28, 1966	May 1, 1966	July 1, 1966	Aug. 20, 1966	Oct. 22, 1966.
Launch	July 8, 1965	Oct. 1, 1965	Mar. 1, 1966	May 2, 1966	July 2, 1966	Aug. 22, 1966	Oct. 23, 1966.
	July 26, 1965	Oct. 20, 1965	Mar. 9, 1966	May 10, 1966	July 12, 1966	Aug. 31, 1966	Nov. 1, 1966.
		Oct. 25, 1965	Mar. 16, 1966	May 17, 1966	July 18, 1966	Sept. 12, 1966	Nov. 11, 1966.

*5001 was returned from ETR for refurbishing on this date and designated 5001R.

**5001R was completely disassembled and rebuilt.

Note:

GATV was a modified standard Agena, a production-line vehicle delivered to the Gemini program as GFE through the standard DD-250 procedure; when delivered it was considered to be flight ready. After modification and reassembly, the same tests certified its readiness as the Gemini Agena Target Vehicle.

Table C—Gemini Target Launch Vehicle

Item	Gemini Target Launch Vehicle						
	TLV-5301	TLV-5302	TLV-5303	TLV-5304	TLV-5305	TLV-5306	TLV-5307
Basic vehicle delivered.....	Apr. 2, 1965	Dec. 2, 1965	Nov. 1, 1965	Jan. 14, 1966	Jan. 14, 1966	Apr. 11, 1966	
Final assembly of booster and sustainer sections.....	May 25, 1965	Jan. 19, 1966	Feb. 15, 1966	Mar. 17, 1966	Mar. 17, 1966	July 27, 1966	
Install flight equipment and Gemini-peculiar kit.....	June 3, 1965	Jan. 24, 1966	Feb. 18, 1966	June 20, 1966	June 20, 1966	Aug. 22, 1966	
Systems test completed.....	July 13, 1965	Mar. 14, 1966	June 1, 1966	July 1, 1966	July 1, 1966	Sept. 9, 1966	
Composite test.....	July 22, 1965	Mar. 23, 1966	June 3, 1966	July 11, 1966	July 11, 1966	Sept. 12, 1966	
Data review and final acceptance.....	July 29, 1965	Mar. 31, 1966	June 6, 1966	July 15, 1966	July 15, 1966	Sept. 15, 1966	
Delivered to ETR.....	Dec. 4, 1964	Aug. 11, 1965	Feb. 13, 1966	July 18, 1966	July 18, 1966	Sept. 19, 1966	
Erected.....		Jan. 5, 1966	June 15, 1966	July 28, 1966	July 28, 1966	Sept. 26, 1966	
Subsystems tests completed.....		Feb. 23, 1966	June 28, 1966	Aug. 16, 1966	Aug. 16, 1966	Oct. 18, 1966	
TLV/GATV mate.....	Oct. 10, 1965	Mar. 1, 1966	May 2, 1966	July 1, 1966	Aug. 22, 1966	Oct. 23, 1966	
Joint Flight Acceptance Composite Test.....		Mar. 7, 1966	May 30, 1966	July 7, 1966	Aug. 26, 1966	Oct. 28, 1966	
Simultaneous launch.....	Oct. 20, 1965	Mar. 9, 1966	May 10, 1966	July 12, 1966	Aug. 31, 1966	Nov. 1, 1966	
Launch.....	Oct. 25, 1965	Mar. 16, 1966	May 17, 1966	July 18, 1966	Sept. 12, 1966	Nov. 11, 1966	

^aThis vehicle had originally been assigned to the Lunar Orbiter program; the loss of the TLV on Gemini IX made necessary an additional Atlas for the Gemini program.

^bSystems tests were completed Mar. 23, 1966, but components were then reworked to latest flight configuration, Mar. 26-May 25, 1966; systems tests were then rerun.

^cVehicle in storage May 11-17, 1966, and undergoing modification for ATDA mission from May 18-20.

^dThis test was repeated Sept. 1, 1966.

^eLaunches were attempted Sept. 9 and 10, 1966.

Table D—Gemini Spacecraft

Item	S/C 1	S/C 2	S/C 3	S/C 4	S/C 5	S/C 6
Equipment installation.....		June 30, 1964	Sept. 12, 1964	Jan. 31, 1965	Mar. 14, 1965	May 4, 1965
Reentry/adaptor mate.....		July 7, 1964	Sept. 27, 1964	Feb. 23, 1965	Apr. 1, 1965	May 12, 1965
Systems Assurance Tests.....				Mar. 2, 1965	Apr. 20, 1965	June 15, 1965
Environmental control system validation.....						
Simulated Flight Test.....		Sept. 16, 1964	Dec. 21, 1964	Mar. 8, 1965	May 19, 1965	June 25, 1965
Altitude chamber test.....	Sept. 23, 1963		Nov. 18, 1964	Mar. 25, 1965	June 1, 1965	July 21, 1965
Shipped to ETR.....	Oct. 4, 1963	Sept. 21, 1964	Jan. 4, 1965	Apr. 4, 1965	June 19, 1965	Aug. 4, 1965
Complex 19/EIIV and G&C.....	Mar. 3, 1964	Oct. 18, 1964	Feb. 4, 1965	Apr. 14, 1965	June 26, 1965	Sept. 9, 1965
Mechanical mate.....	Mar. 5, 1964	Nov. 5, 1964	Feb. 17, 1965	Apr. 23, 1965	July 8, 1965	Sept. 18, 1965
Joint Combined Systems Test.....		Nov. 19, 1964	Feb. 24, 1965	Apr. 30, 1965	July 13, 1965	Sept. 24, 1965
FCMT/Final Systems Test.....		Nov. 19, 1964	Mar. 3, 1965	May 7, 1965	July 16, 1965	Oct. 10, 1965
Wet Mock Simulated Launch/stratation.....	Apr. 3, 1964	Nov. 24, 1964	Mar. 8, 1965	May 13, 1965	July 22, 1965	Oct. 7, 1965
Final Simulated Flight Test.....	Apr. 6, 1964	Jan. 14, 1965	Mar. 18, 1965	May 29, 1965	Aug. 13, 1965	Dec. 9, 1965
Launch.....	Apr. 8, 1964	Jan. 19, 1965	Mar. 23, 1965	June 3, 1965	Aug. 21, 1965	Dec. 15, 1965
Equipment installation.....	June 29, 1965	Sept. 17, 1965	Dec. 7, 1965	Jan. 29, 1966	Apr. 13, 1966	June 4, 1966
Reentry/adaptor mate.....	July 26, 1965	Sept. 20, 1965	Nov. 22, 1965	Feb. 4, 1966	Apr. 8, 1966	June 13, 1966
Systems Assurance Tests.....	Aug. 12, 1965	Oct. 22, 1965	Dec. 30, 1965	Mar. 2, 1966	Apr. 29, 1966	June 30, 1966
Environmental control system validation.....		Oct. 22, 1965	Jan. 11, 1966	Mar. 21, 1966	May 9, 1966	July 7, 1966
Simulated Flight Test.....	Aug. 30, 1965	Nov. 4, 1965	Jan. 21, 1966	Apr. 5, 1966	May 20, 1966	July 30, 1966
Altitude chamber test.....	Sept. 17, 1965	Dec. 13, 1965	Feb. 10, 1966	Apr. 28, 1966	June 15, 1966	Aug. 20, 1966
Shipped to ETR.....	Oct. 9, 1965	Jan. 8, 1966	Mar. 2, 1966	May 13, 1966	July 7, 1966	Sept. 6, 1966
Complex 19/EIIV and G&C.....	Oct. 30, 1965	Feb. 11, 1966	Apr. 14, 1966	June 21, 1966	Aug. 9, 1966	Oct. 6, 1966
Mechanical mate.....	Nov. 22, 1965	Mar. 6, 1966*	May 8, 1966**	July 5, 1966	Aug. 24, 1966	Oct. 25, 1966
Joint Combined Systems Test.....	Nov. 15, 1965	Feb. 16, 1966	Apr. 19, 1966	June 23, 1966	Aug. 12, 1966	Oct. 10, 1966
FCMT/Final Systems Test.....		Feb. 23, 1966	Apr. 28, 1966	July 1, 1966	Aug. 23, 1966	Oct. 19, 1966
Wet Mock Simulated Launch/stratation.....		Mar. 9, 1966	May 10, 1966	July 12, 1966	Sept. 1, 1966	Nov. 1, 1966
Final Simulated Flight Test.....	Nov. 27, 1965	Mar. 10, 1966	May 11, 1966	July 13, 1966	Sept. 2, 1966	Nov. 2, 1966
Launch.....	Dec. 4, 1965	Mar. 16, 1966	June 3, 1966***	July 18, 1966	Sept. 12, 1966†	Nov. 11, 1966

*Temporary mate and erector cycling Feb. 25, 1966.

**Soft mate and erector cycling May 3, 1966.

***Mission scrubbed May 17, 1966, when GATV failed to orbit; systems retest, mate, and EIIV retest completed May 24, repeat of FST May 26. Mission again scrubbed June 1, 1966, because of spacecraft computer problem, followed by recycle and launch.

†Launch attempts on Sept. 9 and 10, 1966.

APPENDIX 4—WORLDWIDE TRACKING NETWORK

[From NASA SP-121]
Capabilities of Network Stations

Station	Station symbol	Real-time telemetry to MCC-H	Acquisition aid	Radar	PCM telemetry ground station	Telemetry record	PAM telemetry (FM/FM) ground station	Flight controller display consoles	Digital command modulation	Radiofrequency command	Spacecraft communications (air-to-ground)	Voice	Teletype
Cape Kennedy.....	CNV												
Mission Control Center.....	MCC-K	X	X	X	X	X	X	X	X	X	X	X	X
Grand Bahama Island.....	GBI	X	X	X	X	X	X		X	X	(*)	X	X
Grand Turk Island.....	GTK	X	X	X	X	X			X	X	(*)	X	X
Bermuda.....	BDA	X	X	X	X	X	X		X	X	X	X	X
Antigua.....	ANT	X	X	X	X	X	X		X	X	(*)	X	X
Grand Canary Island.....	CYI		X	X	X	X	X	X	X	X	X	X	X
Ascension Island.....	ASC			X		X	X			X	(*)	X	X
Kano, Africa.....	KNO		X			X	X			X	X	X	X
Pretoria, Africa.....	PRE			X		X	X						X
Tananarive, Malagasy.....	TAN		X			X	X			X	X	X	X
Carnarvon, Australia.....	CRO		X	X	X	X	X	X	X	X	X	X	X
Woomera, Australia.....	WOM		X	X								X	X
Canton Island.....	CTN		X			X	X			X	X	X	X
Kauai Island, Hawaii.....	HAW		X	X	X	X	X	X	X	X	X	X	X
Point Arguello, Calif.....	CAL		X	X		X	X			X	X	X	X
Guaymas, Mexico.....	GYM		X	X	X	X	X	X		X	X	X	X
White Sands, N. Mex.....	WHS		X	X								X	X
Corpus Christi, Tex.....	TEX	X	X	X	X	X	X	X	X	X	X	X	X
Eglin, Fla.....	EGL		X	X		X	X					X	X
Wallops Island, Va.....	WLP		X	X	X	X	X	X	X	X	X	X	X
Coastal Sentry Quebec (ship).....	CSQ		X		X	X	X	X	X	X	X	X	X
Rose Knot Victor (ship).....	RKV		X		X	X	X	X	X	X	X	X	X
Goddard Space Flight Center.....	GSFC											X	X
Range Tracker (ship).....	RTK			X		X				X	X	X	X

*Through Cape Kennedy Superintendent of Range Operations

APPENDIX 5—COST OF GEMINI PROGRAM (MILLIONS OF DOLLARS)

[Gemini Program Office, NASA Headquarters, Dec. 21, 1966]

Item	Fiscal year						Total
	1962	1963	1964	1965	1966	1967	
Spacecraft.....	30.3	205.1	281.7	165.3	98.9	9.1	790.4
Launch vehicles.....	24.4	79.1	122.7	115.4	72.9	2.9	417.4
Support.....	0.1	4.9	14.5	27.7	25.5	9.6	82.3
Total.....	54.8	289.1	418.9	308.4	197.3	21.6	1290.1

APPENDIX 6—NASA CENTERS AND OTHER GOVERNMENT AGENCIES PARTICIPATING IN THE GEMINI PROGRAM

[From NASA SP-121]

NASA Headquarters, Washington, D.C., and the following NASA centers:

Ames Research Center, Moffett Field, Calif.
 Electronics Research Center, Cambridge, Mass.
 Flight Research Center, Edwards, Calif.
 Goddard Space Flight Center, Greenbelt, Md.
 Kennedy Space Center, Cocoa Beach, Fla.
 Langley Research Center, Langley Station, Hampton, Va.
 Lewis Research Center, Cleveland, Ohio
 Manned Spacecraft Center, Houston, Tex.
 Marshall Space Flight Center, Huntsville, Ala.

Department of Defense, Washington, D.C. :
 Department of the Army
 Department of the Navy
 Department of the Air Force
 Department of State, Washington, D.C.
 Department of Commerce, Washington, D.C.
 Department of the Interior, Washington, D.C.
 Department of Health, Education, and Welfare, Washington, D.C.
 Department of the Treasury, Washington, D.C. :
 U.S. Coast Guard
 Atomic Energy Commission, Washington, D.C.
 Environmental Science Services Administration, Washington, D.C.
 U.S. Information Agency, Washington, D.C.

APPENDIX 7—CONTRACTORS, SUBCONTRACTORS, AND VENDORS (\$100,000 AND OVER)

[Material compiled by George F. MacDougall, Code: GP, Office Director of Administration, NASA Manned Spacecraft Center, Houston, Tex.]

- Accratronics Seals*, Burbank, Calif.—Glass-to-metal seals for spacecraft
- ACF Industries, Inc.*, Paramus, N.J.—Spacecraft C-band and S-band radar beacons and associated aerospace ground equipment (AGE)
- Acoustica Associates, Inc.*, Los Angeles, Calif.—Propellant utilization system for the Atlas
- ACR Electronics Corp.*, New York, N.Y.—UHF recovery beacons for the spacecraft
- Advanced Communications, Inc.*, Chatsworth, Calif.—Command destruct system for Gemini launch vehicle
- **Advanced Technology Laboratories, Division of American Radiator & Standard Corp.*, Mountain View, Calif.—Spacecraft horizon sensor system and associated AGE
- Advanced Technology Laboratories*, Cape Canaveral, Fla.—Engineering field support for spacecraft
- Aerojet-General Corp.*, Downey, Calif.—Study of cryogenic and hypergolic propellants
- **Aerojet-General Corp.*, Sacramento, Calif.—Engines for Gemini launch vehicle and associated AGE
- Aeronca Manufacturing Corp.*, Baltimore, Md.—Closures for spacecraft
- Aeroquip Corp.*, Jackson, Mich.—Spacecraft fittings
- **Aerospace Corp.*, El Segundo, Calif.—Technical support for Atlas, Agena, and Gemini launch vehicle
- Air Products and Chemicals, Inc.*, Allentown, Pa.—Liquid oxygen (LOX) for the Atlas
- Airco Cryogenics, Division of Air Reduction Co., Inc.*, Newark, N.J.—Cryogenic gases for tests of spacecraft
- AiResearch Manufacturing Co., Division of Garrett Corp.*, Cape Canaveral, Fla.—Engineering field support for spacecraft
- **AiResearch Manufacturing Co., Division of Garrett Corp.*, Los Angeles, Calif.—Spacecraft environmental control system, reactants supply system for fuel cell, and associated AGE
- AiResearch Manufacturing Co., Division of Garrett Corp.*, Phoenix, Ariz.—Parts for the spacecraft environmental control system (ECS)
- AiResearch Manufacturing Co., Division of Garrett Corp.*, Torrance, Calif.—Blood pressure measuring system, environmental control system, and environmental facility
- Airite Products, Inc.*, Los Angeles, Calif.—Rocket cases for spacecraft thrusters
- Airtex Dynamics, Inc.*, Compton, Calif.—Tank assemblies for spacecraft
- Allis-Chalmers Mfg. Co.*, Milwaukee, Wis.—Fuel cell test
- American Beryllium Corp.*, Sarasota, Fla.—Ground test equipment and parts for the spacecraft
- *Indicates contracts \$5 million and over
- American Machine and Foundry Co.*, Springdale, Conn.—Ion-exchange membrane for spacecraft fuel cell
- American Machine and Foundry Co.*, Stamford, Conn.—Spacecraft ground test equipment
- American Machine and Foundry Co.*, York, Pa.—Mechanical and pneumatic launch mechanism for Atlas
- American Super-Temp Wire Co.*, Winooski, Vt.—Wire for spacecraft
- Amp, Inc.*, Harrisburg, Pa.—Electrical patchcords and parts for the spacecraft
- Ampep Corp.*, Culver City, Calif.—Recorders for tests of spacecraft and of Atlas
- Analytical Mechanics Associates*, Westbury, N.Y.—Mission planning study.
- Applied Electronics Corp.*, Metuchen, N.J.—Communtators for spacecraft
- ARDE-Portland, Inc.*, Paramus, N.J.—Urine volume measuring system
- Argus Industries, Inc.*, Gardena, Calif.—Hatch actuators for spacecraft
- Associated Machine Co.*, Santa Clara, Calif.—Valve components for Gemini launch vehicle engines
- Astrodota, Inc.*, Anaheim, Calif.—Equipment for tests for spacecraft
- Astro Metallic, Inc.*, Chicago, Ill.—Beryllium shingles for spacecraft
- Autronics Corp.*, Pasadena, Calif.—Time delay relays for Gemini launch vehicle
- AVCO Corp.*, Stratford, Conn.—Range safety system for Atlas
- Avionics Research Corp.*, West Hempstead, N.Y.—Engineering services for spacecraft
- Baldwin Contracting Co.*, Reno, Nev.—Construction of test facility for spacecraft thrusters
- Bechtel Corp.*, San Francisco, Calif.—Space chamber facility study
- Beckman Instruments, Inc.*, Fullerton, Calif.—CO₂ measuring system
- Beech Aircraft Corp.*, Boulder, Colo.—AGE, liquids servicing units for spacecraft
- **Bell Aerosystems Co., Division of Bell Aerospace Corp.*, Buffalo, N.Y.—Primary and secondary propulsion systems for Agena
- Bendix Corp., Pacific Div.*, Sylmar, Calif.—Atlas telemetry equipment
- Bendix Corp., Red Bank Div.*, Eatontown, N.J.—Static inverters for Gemini launch vehicle
- Bendix Corp., Pioneer Central Div.*, Davenport, Iowa—Sensing elements and instrumentation for the spacecraft and Gemini launch vehicle
- Bendix Corp., Eclipse-Pioneer Div.*, Teterboro, N.J.—Spacecraft ground test equipment

- Bissett-Berman Corp.*, Santa Monica, Calif.—Error analysis study
- Bourne, Inc.*, Riverside, Calif.—Transducers and potentiometers for Atlas
- Brodie, Inc.*, San Leandro, Calif.—Flowmeter for Gemini launch vehicle
- Brush Beryllium Co.*, Cleveland, Ohio—Beryllium shingles for spacecraft
- Brush Instrument Division, Clevite Corp.*, Cleveland, Ohio—Recorders for use in testing spacecraft and Gemini launch vehicle
- **Burroughs Corp.*, Paoli, Pa.—Computer modifications and computation services during launch of Atlas and Gemini launch vehicle
- Burtek, Inc.*, Tulsa, Okla.—Spacecraft systems trainers
- Cadillac Gage Co.*, Detroit, Mich.—Accumulator reservoir for Gemini launch vehicle
- Calcor Space Facility, Inc.*, Whittier, Calif.—Shielded cabinets and consoles for spacecraft AGE
- Cannon Electric Co.*, Phoenix, Ariz.—Electrical receptacles and plugs for spacecraft
- Cannon Electric Co.*, Los Angeles, Calif.—Plugs and receptacles for Gemini launch vehicle
- CBS Labs, Inc.*, Stamford, Conn.—Spacecraft onboard voice recorder
- Central Technology Corp.*, Herrin, Ill.—Pyrotechnics for spacecraft
- Christie Machine Works*, San Francisco, Calif.—First stage nozzles for Gemini launch vehicle engines
- Clary Corp.*, San Gabriel, Calif.—Solenoid assemblies and pressurization units for spacecraft, valves, heaters, and switches for the Atlas engines
- Clifton Precision Products Co.*, Clifton Heights, Pa.—Synchro transmitter and resolver for spacecraft
- Collins Radio Co.*, Cedar Rapids, Iowa.—Spacecraft voice communications system and associated AGE
- Columbia Tool Steel Co.*, Chicago Heights, Ill.—Tool steel for manufacturing spacecraft parts
- Comprehensive Designers, Inc.*, Philadelphia, Pa.—Engineering services for spacecraft
- Computer Control Co., Inc.*, Framingham, Mass.—Computers for ground tests of spacecraft
- Conductron Corp., Missouri Div.*, St. Charles, Mo.—Spacecraft simulators and training aids
- Consolidated Electrodynamics Corp.*, Pasadena, Calif.—Galvanometers for tests of Gemini launch vehicle
- Control Data Corp.*, Minneapolis, Minn.—Computer and ancillary equipment for tests of spacecraft
- Cook Electric Co.*, Morton Grove, Ill.—Biomedical recorder
- Corning Glass Works*, Corning, N.Y.—Spacecraft windows
- Cosmodyne Corp.*, Hawthorne, Calif.—Converters for spacecraft AGE
- CTL Division, Studebaker Corp.*, Cincinnati, Ohio—Tests of ablation materials
- Cutler-Hammer, Inc.*, Long Island City, N.Y.—Radio telescope
- **David Clark Co., Inc.*, Worcester, Mass.—Spacesuits and associated AGE
- Day & Zimmerman, Inc.*, Los Angeles, Calif.—Engineering services for spacecraft
- DeHavilland Aircraft, Ltd.*, Downsview, Ontario, Canada—HF whip antenna and UHF antenna for spacecraft; transponder boom for target docking adapter
- Dilectrix Corp.*, Farmingdale, N.Y.—Spacecraft fuel tank bladders
- Douglas Aircraft Co., Inc.*, Santa Monica, Calif.—Machined parts for spacecraft
- Douglas Aircraft Co., Inc.*, Tulsa, Okla.—Agena shroud and toolings and machined parts for spacecraft
- Eagle-Picher Co.*, Joplin, Mo.—Batteries for the spacecraft
- Edgerton, Germeshausen & Grier, Inc.*, Boston, Mass.—Acquisition light on target docking adapter
- Electra Manufacturing Co.*, Independence, Kans.—Resistors for spacecraft
- **Electro-Mechanical Research, Inc.*, Sarasota, Fla.—Spacecraft data transmission system and associated AGE
- Electro-Optical Systems, Inc.*, Pasadena, Calif.—Beta spectrometer and equipment for plasma wake experiment
- Electro Tec Corp.*, West Caldwell, N.J.—Slip rings for spacecraft systems
- Elgin National Watch Co.*, Elgin, Ill.—Fuel remaining indicator for spacecraft
- Emerson Electric Co.*, St. Louis, Mo.—Engineering services, template tooling, and metal fabricating for spacecraft
- Emertron Information and Control Division, Litton Systems, Inc.*, Silver Spring, Md.—S-band and C-band antenna systems for spacecraft
- Englehard Industries, Inc.*, Newark, N.J.—Platinum for spacecraft fuel cell
- Engineered Magnetic Division, Gulton Industries, Inc.*, Hawthorne, Calif.—Linear accelerometers and AGE for spacecraft and power supplies for Gemini launch vehicle
- Enthone, Inc.*, New Haven, Conn.—Goldspray for spacecraft adapter
- Epaco, Inc.*, Westwood, Mass.—Multiplex encoder for Gemini launch vehicle
- Explosive Technology, Inc.*, Santa Clara, Calif.—Pyrotechnic device (separation assembly to cut adapter) for spacecraft
- Fairchild Camera and Instrument Corp.*, El Cajon, Calif.—Vaned elbow assemblies for Gemini launch vehicle engines
- Fairchild Camera and Instrument Corp., Cable Division*, Joplin, Mo.—Cables for spacecraft AGE
- Fairchild Camera and Instrument Corp., Fairchild Controls Division*, Hicksville, N.Y.—Transducers for spacecraft and Gemini launch vehicle
- Fairchild Hiller Corp., Stratos Division*, Manhattan Beach, Calif.—Quick disconnects for Gemini launch vehicle and bellows and flexible lines for the Atlas
- Fairchild Hiller Corp., Stratos Division*, Bay Shore, N.Y.—Coldplate assemblies and AGE for the spacecraft

PROJECT GEMINI: A CHRONOLOGY

- Farrand Optical Co., Inc.*, Bronx, N.Y.—Simulator image display system
- Federal Electric Corp.*, Paramus, N.J.—Logistic support
- Federal-Mogul Corp.*, Los Alamitos, Calif.—Spacesuit equipment
- Fluidgenics, Inc.*, National City, Calif.—LOX and fuel regulators for the Atlas
- F M C Corp.*, Baltimore, Md.—Propellant for Gemini launch vehicle
- **General Dynamics*, San Diego, Calif.—Atlas launch vehicle and launch services
- General Dynamics/Convair Division*, Fort Worth, Tex.—Personnel dosimeter
- **General Electric Co.*, Syracuse, N.Y.—MISTRAM system and guidance system components for Gemini launch vehicle and for the Atlas
- General Electric Co.*, Pittsfield, Mass.—Parts for the spacecraft fuel cell
- **General Electric Co.*, West Lynn, Mass.—Spacecraft fuel cell and associated AGE
- General Electric Co.*, St. Louis, Mo.—Engineering services and AGE for spacecraft
- General Electric Co.*, Waynesboro, Va.—Parts for the spacecraft fuel cell system
- General Monitors*, El Segundo, Calif.—Combustible gas detectors for the spacecraft
- General Motors Corp.*, Milwaukee, Wis.—Dual inertial measuring unit study
- General Precision, Inc., Link Division*, Riverdale, Md.—Software for spacecraft simulators
- General Precision, Inc., Kearfott Division*, Little Falls, N.J.—Atlas rate integrating gyros and spacecraft synchro transmitter and resolver
- General Precision, Inc., Link Division*, Binghamton, N.Y.—Computer for spacecraft simulator and tape preparation for mission simulators
- General Precision, Inc.*, Pleasantville, N.Y.—Closed circuit TV system and modification for Gemini mission simulator
- Giannini Controls Corp.*, Duarte, Calif.—Rate switch package for Gemini launch vehicle
- B. F. Goodrich Co.*, Akron, Ohio—Spacesuit equipment
- Goodyear Aerospace Corp.*, Akron, Ohio—Paraglider components and ballute stabilization system for spacecraft
- Gray & Huleguard, Inc.*, Santa Monica, Calif.—Spacecraft electrical disconnect (from Agena target vehicle)
- Grimes Manufacturing Co.*, Urbana, Ohio—Telelight panel assembly for spacecraft
- Gulton Industries, Inc.*, Metuchen, N.J.—Linear accelerometer for spacecraft
- B. H. Hadley, Inc., Division of Royal Industries*, Pomona, Calif.—Atlas LOX and fuel regulators and relief valves
- *Indicates contracts \$5 million and over
- Hamilton-Standard, Division of United Aircraft Corp.*, Windsor Locks, Conn.—AGE for spacecraft reentry and control system, orbit attitude and maneuvering system; temperature control unit for the Gemini launch vehicle
- Harris Manufacturing Co.*, St. Louis, Mo.—Control handles for spacecraft
- Hartman Electrical Manufacturing Co.*, Mansfield, Ohio—Relays for spacecraft
- A. W. Hecker Co.*, Cleveland, Ohio—Machined fittings for spacecraft
- Heinemann Electric Co.*, Trenton, N.J.—Circuit breakers for spacecraft
- Hercules Powder Co.*, Bessemer, Ala.—Propellant for Agena
- Hercules Powder Co.*, Hercules, Calif.—Propellant for Gemini launch vehicle
- Hexcel Products, Inc.*, Berkeley, Calif.—Core assembly and honeycomb shield for spacecraft
- High Vacuum Equipment Corp.*, Hingham, Mass.—Ground test equipment for spacecraft
- Hoefner Corp.*, El Monte, Calif.—Valves and switches for Atlas engines
- Honeywell Inc.*, West Covina, Calif.—Albedo simulator
- **Honeywell Inc.*, St. Petersburg, Fla.—Spacecraft inertial measuring unit and associated AGE
- **Honeywell Inc.*, Minneapolis, Minn.—Spacecraft rate gyros, attitude and control maneuver electronics, and associated AGE; Gemini launch vehicle three-axis reference system package; Atlas rate gyros; and paraglider control electronics and rate simulators
- Honeywell Inc.*, St. Louis, Mo.—Engineering field support for spacecraft
- Houston Fearless Corp.*, Torrance, Calif.—Fuel and oxidizer metering units for spacecraft
- Hurletron Corp.*, Wheaton, Ill.—Time delay relay for spacecraft
- Hydra Electric Co.*, Burbank, Calif.—Pressure switch for Gemini launch vehicle
- Hydraulic Research and Manufacturing Co.*, Burbank, Calif.—Relief valves and actuators for Atlas
- **International Business Machines Corp.*, Bethesda, Md.—Computer complex
- **International Business Machines Corp.*, Owego, N.Y.—Spacecraft onboard computer, incremental velocity indicator, manual data insertion unit and associated AGE; post flight analysis of spacecraft maneuvering
- International Business Machines Corp.*, St. Louis, Mo.—Engineering field support for spacecraft
- Jet Air Engineering Corp.*, El Cajon, Calif.—Reinforced hat band assembly for Atlas engine
- Johns-Manville Corp.*, Manville, N.J.—Insulation material for spacecraft
- Kaiser Aerospace and Electronics Co.*, San Leandro, Calif.—First stage engine frames for Gemini launch vehicle
- Walter Kidde and Co., Inc.*, Belleville, N.J.—Gas generator solenoid valves for Agena propulsion systems

- Kinetics Corp.*, Solana Beach, Calif.—Motor driven switches for Gemini launch vehicles and for Atlas
- Kirk Engineering Co.*, Philadelphia, Pa.—Engineering services for the spacecraft
- Kollsman Instrument Corp.*, Elmhurst, N.Y.—Spacecraft altimeter
- L. A. Gauge Co., Inc.*, Sun Valley, Calif.—Machining throats for spacecraft thrusters
- La Mesa Tool and Manufacturing, Inc.*, El Cajon, Calif.—Gas generator assembly, injector baffles, and gas coolers for Gemini launch vehicle engines
- Leach Corp.*, Los Angeles, Calif.—Control relays for spacecraft
- Lear-Siegler, Inc.*, Anaheim, Calif.—Closed circuit TV system for spacecraft simulators
- Lear-Siegler, Inc.*, Grand Rapids, Mich.—Spacecraft attitude indicator system, incremental velocity indicator system, and associated AGE
- Marion Lee Corp.*, El Segundo, Calif.—Solenoid and valve assemblies for spacecraft
- Lel Inc.*, Copiague, N.Y.—Receivers and discriminators for spacecraft
- Ling-Temco-Vought, Inc.*, Dallas, Tex.—Spacecraft parts, detector system
- Lion Research Corp.*, Cambridge, Mass.—CO₂ partial pressure system for spacecraft
- **Lockheed Missiles and Space Co.*, Sunnyvale, Calif.—Agena target vehicle, associated AGE, and launch services
- Lytron Inc.*, Cambridge, Mass.—Pressure sensor and oxygen purge valve for spacecraft
- Maffett Tool and Machine Co.*, St. Louis, Mo.—Hinge fittings for spacecraft
- Martin Co., Division of Martin-Marietta Corp.*, Denver, Colo.—Tanks for Gemini launch vehicle
- **Martin Co., Division of Martin-Marietta Corp.*, Baltimore, Md.—Gemini launch vehicles, associated AGE, and launch services
- J. A. Maurer, Inc.*, Long Island City, N.Y.—Cameras for flight use
- McCormick Selph Assoc., Division of Teledyne, Inc.*, Hollister, Calif.—Voltage detectors and cartridges for Gemini launch vehicle
- **McDonnell Astronautics Co., McDonnell Douglas Corp.*, St. Louis, Mo.—Gemini spacecraft, associated AGE, and launch services
- McGregor Manufacturing Co.*, Troy, Mich.—First and second stage turbine manifold assemblies for Gemini launch vehicle engines
- Meg Products, Inc.*, Seattle, Wash.—Cables for spacecraft AGE
- Menasco Manufacturing Co.*, Burbank, Calif.—Helium bottles for the Atlas
- D. B. Milliken, Inc.*, Arcadia, Calif.—Photograph recorders
- Minnesota Mining and Manufacturing Co.*, Hutchinson, Minn.—Magnetic tape for ground tests of the spacecraft
- Missouri Research Laboratories, Inc.*, St. Louis, Mo.—Spacecraft reentry module instrumentation simulator and engineering services
- Monsanto Chemical Co.*, St. Louis, Mo.—Coolant fluid for spacecraft
- Moog Servocontrols, Inc.*, E. Aurora, N.Y.—Actuators for Gemini launch vehicle
- **Motorola, Inc.*, Scottsdale, Ariz.—Spacecraft digital command system and associated AGE, Agena UHF command receiver and C-band transponder
- National Semiconductor Corp.*, Danbury, Conn.—Transistors for spacecraft
- National Water Lift Co.*, Kalamazoo, Mich.—Hatch actuator and shut-off valves for spacecraft
- **North American Aviation, Inc., Rocketdyne Division*, Canoga Park, Calif.—Spacecraft reentry control system, orbit attitude and maneuvering system, and associated AGE; engines for the Atlas
- **North American Aviation, Inc., Space & Information Systems Division*, Downey, Calif.—Paraglider landing system
- North American Aviation, Inc.*, Cape Kennedy, Fla.—Engineering field support for spacecraft
- **Northrop Corp., Ventura Division*, Newbury Park, Calif.—Spacecraft landing system (parachutes)
- Northrop Corp.*, Van Nuys, Calif.—Emergency recovery parachute system for paraglider
- Olin Mathieson Chemical Corp.*, Lake Charles, La.—Propellant for Agena
- Olin Mathieson Chemical Corp.*, Saltville, Va.—Propellant for Gemini launch vehicle
- Ordnance Associates, Inc.*, South Pasadena, Calif.—Pyrotechnic separation devices for the spacecraft
- Ordnance Engineering Associates, Inc.*, Des Plaines, Ill.—Actuator assemblies for spacecraft
- Pacific Automation*, Glendale, Calif.—Cable assemblies for Atlas
- Palomar Scientific Corp., Division of United Control Corp.*, Redmond, Wash.—Transducers for Gemini launch vehicle
- Paragon Tool, Die and Engineering Co.*, Pacoima, Calif.—Turbine rotor impellers for Gemini launch vehicle engines
- Parker Aircraft Co.*, Los Angeles, Calif.—Hydraulic packages for Atlas engines
- Philco Corp.*, Philadelphia, Pa.—Engineering support
- **Philco Corp., WDL Division*, Palo Alto, Calif.—Mission Control Center (Houston)
- Pioneer Astro Industries*, Chicago, Ill.—Beryllium shingles for the spacecraft
- Pneumodynamics Corp.*, Kalamazoo, Mich.—Motor operated valves and pressure regulators for the spacecraft
- Pollack & Skan, Inc.*, Chicago, Ill.—Engineering services for the spacecraft
- Powerton, Inc.*, Plainsville, N.Y.—Parts for the Gemini launch vehicle
- Precision Sheet Metal, Inc.*, Los Angeles, Calif.—Thrust chamber tubes for the Gemini launch vehicle engines

PROJECT GEMINI: A CHRONOLOGY

- Pressure Systems, Inc.*, Los Angeles, Calif.—Helium bottles and spheres for the Atlas
- Pyronetics, Inc.*, Santa Fe Springs, Calif.—Pyrotechnics for the spacecraft
- Rader & Associates*, Miami, Fla.—Architect and engineering design for modification to launch stand for Gemini launch vehicle
- Radiation, Inc., Melbourne Division*, Melbourne, Fla.—Data processing systems for the spacecraft, parts for the checkout system
- Radio Corporation of America*, Camden, N.J.—Pulse code modulator recorder for the spacecraft
- Raychem Corp.*, Redwood City, Calif.—Wire for the spacecraft
- Raymond Engineering Laboratory, Inc.*, Middletown, Conn.—Auxiliary tape memory for spacecraft on-board computer
- Raytheon Co.*, Hawthorne, Calif.—Semiconductors for the Atlas
- Razdow Lab.*, Newark, N.J.—Solar optical telescope
- Reeves Instrument Co.*, Garden City, N.Y.—Alignment tester for the Gemini launch vehicle
- Reinhold Engineering Co.*, Santa Fe Springs, Calif.—Nozzle sleeves for spacecraft thrusters
- Rocket Power, Inc.*, Mesa, Ariz.—Seat ejector (rocket catapult) for the spacecraft
- Rome Cable Corp., Division of Alcoa*, Rome, N.Y.—Cables for spacecraft AGE
- Rosemont Engineering Co.*, Minneapolis, Minn.—Temperature sensor elements for spacecraft
- S&Q Construction Co.*, Chatsworth, Calif.—Construction of test facility for spacecraft thrusters
- S&Q Construction Co.*, Reno, Nev.—Construction of test facility for spacecraft thrusters
- Scientific Data Systems, Inc.*, Santa Monica, Calif.—Computer
- Servonic Instruments, Inc.*, Costa Mesa, Calif.—Pressure transducers for Gemini launch vehicle, for the Atlas, and for the spacecraft
- Snap Tite Inc.*, Union City, Pa.—Disconnects and couplers for the spacecraft
- Southwest Industries, Inc.*, Los Angeles, Calif.—Switches for Atlas engines
- Space Corp.*, Dallas, Tex.—Transportation trailers for spacecraft
- Space Equipment Corp.*, Torrance, Calif.—Spacecraft and paraglider checkout equipment
- Space Labs, Inc.*, Van Nuys, Calif.—Biinstrumentation
- Space Technology Labs, Inc.*, Redondo Beach, Calif.—Orbital rendezvous studies and guidance equations for the Atlas
- Spacecraft Welding and Manufacturing Co.*, Inglewood, Calif.—Spacecraft tank assemblies
- Sperry Rand Corp., Sperry Phoenix Co.*, Phoenix, Ariz.—UHF radio beacon transmitter
- Sperry Rand Corp., Vickers Division*, Torrance, Calif.—Pneumatic pitch and roll control actuation subsystem for paraglider
- Sperry Rand Corp.*, Tampa, Fla.—Leveling electronic units for the spacecraft test equipment
- Sperry Rand Corp., Vickers Division*, Detroit, Mich.—Hydraulic pumps for Gemini launch vehicle and for the Atlas
- Sperry Rand Corp.*, Washington, D.C.—Computer equipment
- Speidel Inc.*, Warwick, R.I.—Recorder for tests of the Gemini launch vehicle
- Standard Oil Company of New Jersey*, Bayonne, N.J.—Fuel for the Atlas
- Superior Manufacturing and Instrument Corp.*, Long Island City, N.Y.—Synchro repeater for the spacecraft
- Talley Industries*, Mesa, Ariz.—Actuators and horizon scanner release assembly for the spacecraft
- Talley Corp.*, Newbury Park, Calif.—Electro-mechanical actuator for the spacecraft
- Taylor Forge & Pipe Works*, Chicago, Ill.—Forged titanium parts for the spacecraft
- Teledyne Systems Corp.*, Hawthorne, Calif.—Computer data recording system for spacecraft tests
- Texas Institute for Rehabilitation and Research*, Houston, Tex.—Immobilization unit
- Texas Instruments, Inc.*, Dallas, Tex.—Transistors for spacecraft and signal conditioner for Gemini launch vehicle
- Thiokol Chemical Corp., Elkton Division*, Elkton, Md.—Spacecraft retrograde rockets and associated AGE, rocket tests
- Thiokol Chemical Corp., Reaction Motor Div.*, Denville, N.J.—Valves for the Gemini launch vehicle and the Atlas
- Thiokol Chemical Corp., Bristol Division*, Bristol, Pa.—Initiators for the Gemini launch vehicle
- H. I. Thompson Fiber Co.*, Gardena, Calif.—Billets for spacecraft thrusters
- **Thompson Ramo Wooldridge, Inc.*, Redondo Beach, Calif.—Trajectory calculations
- Titanium Metals Corp.*, Toronto, Ohio—Titanium for the spacecraft
- Todd Shipyards Corp.*, Galveston, Tex.—Modifications to NASA's recovery ship, *U.S.S. Retriever*
- Turbo Cast Inc.*, Los Angeles, Calif.—Turbine wheel castings and blades for the Atlas engines
- U.S. Engineering Co.*, Van Nuys, Calif.—Printed circuit boards for the spacecraft
- Union Carbide Corp., Linde Division*, Whiting, Ind.—Liquid nitrogen for tests of the spacecraft
- Union Carbide Corp., Linde Division*, New York, N.Y.—LOX for the Atlas
- Union Carbide Corp.*, Lawrenceberg, Tenn.—Graphite billets for spacecraft thrusters
- Vacco Valve Co.*, El Monte, Calif.—Valves and filters for tests of spacecraft
- Valcor Engineering Corp.*, Kenilworth, N.J.—Valves for the spacecraft
- Vector Manufacturing Co.*, Southampton, Pa.—Acquisition aid beacon for the spacecraft

*Indicates contracts \$5 million and over

APPENDIX 7

- **Weber Aircraft Corp.*, Burbank, Calif.—Spacecraft ejection seats and associated AGE
- Western Gear Corp., Precision Products Division*, Lynwood, Calif.—First and second stage gear box assemblies for the Gemini launch vehicle engines, and hoisting winches
- Western Instruments*, Newark, N.J.—Environmental instrumentation for the spacecraft
- Western Way Inc.*, Chatsworth, Calif.—Ducts, tanks, and aspirators for the Atlas engines
- Western Way Inc.*, Van Nuys, Calif.—Vaned elbow assemblies and super heaters for the Gemini launch vehicle engines
- **Westinghouse Electric Corp.*, Baltimore, Md.—Spacecraft rendezvous radar and transponder in target docking adapter and associated AGE
- Whirlpool Corp.*, St. Joseph, Mich.—Food and waste management system
- Whiting Turner Contracting Co.*, Baltimore, Md.—Modifications to the Gemini launch vehicle vertical test fixture
- Whittaker Corp.*, Chatsworth, Calif.—Transducers for the Atlas
- Wyle Laboratories*, El Segundo, Calif.—Ground tests of spacecraft and Gemini launch vehicle equipment
- Yardney Electric Corp.*, New York, N.Y.—Batteries for the Gemini launch vehicle and for the Atlas
- H. L. Yoh Co.*, Philadelphia, Pa.—Engineering services for the spacecraft

APPENDIX 8—MANNED SPACE FLIGHT RECORD SUMMARY OF MERCURY AND GEMINI FLIGHTS

[From Mercury and Gemini Mission Reports]

Mission, crew	Date	Spacecraft flight time (hr:min:sec)	Orbits/Revolutions	Mission Man-hours (hr:min:sec)	Cumulative Man-hours (hr:min:sec)	Recovery Area	Recovery Ship, U.S.S.	Significant Events
MR-3 Shepard	May 5, 1961	15:22	-----	15:22	15:22	Atlantic	Lake Champlain	First manned suborbital.
MR-4 Grissom	July 21, 1961	15:37	-----	15:37	30:59	Atlantic	Randolph	Second manned suborbital.
MA-6 Glenn	Feb. 20, 1962	4:55:23	3.0	4:55:23	5:26:22	Atlantic	Noa	First orbital.
MA-7 Carpenter	May 24, 1962	4:56:05	3.0	4:56:05	10:22:27	Atlantic	Pierce	Three orbits.
MA-8 Schirra	Oct. 3, 1962	9:13:11	6.0	9:13:11	19:35:38	Pacific	Kearsarge	Six orbits.
MA-9 Cooper	June 15-16, 1963	34:19:49	22.0	34:19:49	53:55:27	Pacific	Kearsarge	Twenty-two orbits.
Gemini III Grissom and Young	Mar. 23, 1965	4:52:31	3.0	9:45:02	63:40:29	Atlantic	Intrepid	First two-man orbital.
Gemini IV McDivitt and White	June 3-7, 1965	97:56:12	62.0	195:52:24	259:32:53	Atlantic	Wasp	First extravehicular activity.
Gemini V Cooper and Conrad	Aug. 21-29, 1965	190:55:14	120.0	381:50:28	641:23:21	Atlantic	Lake Champlain	Long-duration mission.
Gemini VII Borman and Lovell	Dec. 4-18, 1965	330:35:01	206.0	661:10:02	1302:33:23	Atlantic	Wasp	Long-duration, rendezvous.
Gemini VI-A Schirra and Stafford	Dec. 15-16, 1965	25:51:24	16.0	51:42:48	1354:16:11	Atlantic	Wasp	Rendezvous.
Gemini VIII Armstrong and Scott	Mar. 16, 1966	10:41:26	6.6	21:22:52	1375:39:03	Pacific	Mason	Rendezvous, first docking.
Gemini IX-A Stafford and Cernan	June 3-6, 1966	72:20:50	45.0	144:41:40	1520:20:43	Atlantic	Wasp	Rendezvous, extravehicular activity.
Gemini X Young and Collins	July 18-21, 1966	70:46:39	43.0	141:33:18	1661:54:01	Atlantic	Guadalcanal	Rendezvous, dock, extravehicular activity, altitude record (475 mi.).
Gemini XI Conrad and Gordon	Sept. 12-15, 1966	71:17:08	44.0	142:34:16	1804:28:17	Atlantic	Guam	Rendezvous, dock, extravehicular activity, altitude record (853 mi.).
Gemini XII Lovell and Aldrin	Nov. 11-15, 1966	94:34:31	59.0	189:09:02	1993:37:19	Atlantic	Wasp	Rendezvous, dock, extravehicular activity.

Total United States Flight Time (hr:min:sec) 1023:46:23 Total Manhours (hr:min:sec) 1993:37:19

*The *Intrepid* picked up the astronauts; the *Pierce* retrieved the spacecraft.

INDEX

A

- Ablation materials, 41
- Abort, 27, 49, 146
criteria, 39, 194
high-altitude, suborbital, 34, 98
modes, 94
off-the-pad, 31, 32, 49, 50
retrorocket, 4
trainer, 194
- Abort Panel, 194
See also Gemini Abort Panel.
- ACF Electronics Division. *See* ACF Industries, Inc.
- ACF Industries, Inc., 38, 60
- Adapter section, 10, 11, 16, 18, 26, 33, 34, 65, 84, 87, 100, 137, 154, 230, 234, 259
See also Gemini spacecraft.
- Advanced Mercury configuration, 4, 11
- Advanced Mercury spacecraft, 6, 15
- Advanced Paraglider Trainer, 53, 71, 90, 120
- Advanced Technology Laboratories, Inc., 33
- AEDC. *See* Arnold Engineering Development Center.
- Aerodynamic lift, 8
- Aerodynamics Section, 4
See also Flight Systems Division.
- Aeromet-General Corporation, 34, 54, 62, 76, 90, 103, 112, 113, 116, 125, 126, 137, 149, 156, 171, 185, 207, 208, 218, 220, 231
Liquid Rocket Plant, 54
- Aeronautical Division. *See* Minneapolis-Honeywell Regulator Company.
- Aerospace and Defense Products Division. *See* B. F. Goodrich Company.
- Aerospace Corporation, 23, 39, 44, 52, 62, 75, 80, 84, 85, 94, 133, 143, 153, 156, 182, 185, 191, 195, 203, 213, 220
- Aerospace Division of Vickers, Inc., 83
- Aerospace ground equipment, 19, 34, 41, 49, 61, 101, 105, 147, 149, 154, 157, 170, 193
recorders, 142
- Aerospace Medical Research Laboratory (6750th) (USAF), 92
- Agena, 6, 18, 22, 32, 39, 62, 65, 92, 112, 127, 138, 157
communications and control subsystem, 92
main engine, 104, 148, 218, 220
primary propulsion system, 133
See also Target vehicle.
- Agena B, 14, 55
See also Target vehicle.
- Agena command and communication system, 85, 186
- Agena D (AD), 55, 148
modifications, 157, 170, 171, 181, 206, 207, 232
external status displays, 57
secondary propulsion systems, 55
AD-71, 143
AD-82, 170, 171
AD-108, 206, 207
AD-129, 232
AD-130, 239
- Agena Flight Safety Review Board, 216, 218
- Agena procurement, 20
schedule, 31
- Agena rendezvous vehicle, 23, 145
- Agena target vehicle, 14, 28, 29, 32, 43, 58, 79, 98, 104, 123, 136, 146, 168, 248
launch schedule, 21, 62, 63, 92
transponder, 28
- AiResearch Manufacturing Company, 24, 25, 33, 98, 132, 143, 151, 155, 182, 186
- Air Force. *See* United States Air Force.
- Air Force Missile Test Center
See United States Air Force.
- Air Force School of Aviation Medicine
See United States Air Force.
- Air Force Space Systems Division/Aerospace Vehicle Acceptance Team, 113, 116
- Air Force Systems Command, 18, 20, 42, 90, 119, 137, 216
Ballistic Systems Division, 93, 119
Space Systems Division, 18, 119, 182, 187, 191, 217, 227, 229
responsibilities, 18
See also United States Air Force.
- Air Force 6511th Test Group
See United States Air Force.
- Aircraft
C-130, 90
C-133, 152
F-106, 147, 181
KC-135, 92, 145, 164, 177
T-33, 157
T-38, 234
- Akron, Ohio, 8, 37
- Albert, John G., 177, 217
- Aldrin, Edwin E., Jr., 119, 138, 231, 239, 247, 259, 261
- Alexander, Charles C., xiii, 61
- Altitude Chamber Tests, 109, 150, 156, 161, 171, 186, 189, 194, 197, 203, 211, 222
- Ames Research Center (ARC), 1, 4, 37, 41, 47, 67, 71, 103, 104, 131
full-scale test facility, 47
wind tunnel tests, 5, 37, 47, 119
half-scale inflatable paraglider wing, 47, 104
large-scale inflatable paraglider wing, 47
- AMR. *See* Atlantic Missile Range.
- AMU. *See* Astronaut maneuvering unit.
- AMU Final Systems Test, 241
- Anders, William A., 119, 239
- Anechoic chamber test, 113, 182, 187, 188
- Antenna systems, 71, 139
- Apogee, 63, 210, 232, 244, 255
first apogee rendezvous feasibility, 255
- Apollo. *See* Apollo Program and Project Apollo.
- Apollo facilities, 66
- Apollo Program, v, 17, 54, 60
See also Project Apollo.
- Arabian Sea, 255
- Armstrong, Neil A., 60, 75, 106, 184, 215, 235, 239
- Armstrong, Stephen D., 135
- Army Corps of Engineers, 47, 54

- Arnold Engineering Development Center (AEDC), 89,
99, 104, 108, 123, 141, 220, 239
rocket test facility, 89, 239
test cells, 89
wind tunnel, 5
- Arnold, Robert E., 39
- Arrowhead Products Division. *See* Federal-Mogul Corporation.
- Artificial gravity mission, 5, 6
- Astronaut Activities Office, 73
- Astronaut maneuvering unit (AMU), 233, 234, 239, 241, 242, 245, 246, 258
experiment, 258
- Astronaut training, 76, 96, 113
aerodynamics, 76
astronomy, 76
celestial recognition, 76
centrifuge, 76, 162
communications, 76
computer, 76
docking practice, 76
egress, 185
environmental control systems, 76
flight simulator, 76, 91
fluid mechanics, 76
global meteorology, 76
guidance and navigation computers, 76
ingress, 131, 145
launch abort, 147
medical aspects of space flight, 14, 76
parachute jumping, 76, 113, 161
paraglider flying, 76
physics of the upper atmosphere and space, 76
rocket propulsion systems, 76
selenology, 76
survival training, 76, 106
weightless flying, 76, 92, 162, 177
- Astronauts, 5, 36, 39, 60, 75, 119, 131, 139, 154
- Atkinson, A. H., 34
- Atlantic Missile Range (AMR), 55, 74, 89, 96, 108, 109, 117, 118, 121, 143
- Atlantic Ocean, 32, 140, 179, 202, 210, 229, 243, 256
- Atlas (intercontinental ballistic missile), 56
- Atlas launch vehicles, 12, 13, 14, 18, 73, 108
- Atlas 5803, 257
redesignated TLV 5307, 257
- Atlas 7127, 257
- Atlas procurement, 20
- Atlas standard launch vehicle (SLV), 56
- Atlas standard launch vehicle (SLV 3) 5301, 168, 170, 184, 202, 205, 207, 244
erected on complex 14, 170, 184, 202
roll-out inspection, 168
See also Target launch vehicle 5301.
- Atlas standard launch vehicle (SLV) 5302, 208, 229
target launch vehicle for *Gemini VIII*, 229
See also Target launch vehicle 5302.
- Atlas standard launch vehicle (SLV) 5303, 229, 240, 241
target launch vehicle for *Gemini IX*, 229, 240
trucked to Cape Kennedy, 229
See also Target launch vehicle 5303.
- Atlas standard launch vehicle (SLV) 5304, 240, 257
See also Target launch vehicle 5304.
- Atlas standard launch vehicle (SLV) 5305, 247, 257
See also Target launch vehicle 5305.
- Atlas standard launch vehicle (SLV) 5306, 251, 252
See also Target launch vehicle 5306.
- Atlas standard launch vehicle (SLV) 5307, 257
See also Target launch vehicle 5307.
- Atlas-Agena, 73, 74, 87
- Atlas-Agena B, 5, 14, 18, 22, 27, 44
modifications, 23
- Atlas-Agena configuration, 55
- Atlas-Agena coordination meeting, 41, 53, 89, 92
- Atlas-Agena systems integration, 20
- Atlas-Centaur, 11
- Atmospheric reentry simulation study, 2, 92
- Atomic Energy Commission (AEC), 61
- Attitude control and maneuvering electronics, 29, 34, 41, 63, 89, 238
- Augmented target docking adapter, 221, 222, 231, 232, 244, 245, 257
- Austin, Texas, 217
- Automatic checkout equipment, 75
- Automatic reentry, 255, 259
- Automatic switchover, 169
- Autopilot, 254, 259
- Auxiliary equipment rack, 42, 143, 188
- Auxiliary tape memory unit, 235, 237
- Aviation Medical Acceleration Laboratory (USN), 102
- Azusa, California, 34

B

- Bailey, Glenn F., 7, 16, 31
- Ballard, H. J., 86
- Ballistic Systems Division, 85, 90
Titan Program Office, 90
See also Air Force Systems Command.
- Ballute, 78, 176, 184
36-inch diameter, 122, 124
42-inch diameter, 123
48-inch diameter, 123
qualification program, 123, 141
stabilization system, 78, 123, 141
- Baltimore, Maryland, 14, 28, 51, 52, 80, 113, 153, 167, 208, 213
- Bassett, Charles A., II, 119, 219, 234
- Batteries, 11, 42, 73, 101, 116, 157, 158, 196
qualification program, 114
silver-zinc, 16, 72, 126
for spacecraft No. 3, 126
- Bay of Bengal, 255
- Bean, Alan L., 119, 239, 248
- Bell Aerosystems Company, 55, 88, 104, 133, 134, 138, 158, 163, 191, 218, 220, 221, 229, 230, 232
- Bendix Field Engineering Corporation, 184
- Beryllium shingles, 121
- B-FACT. *See* Booster Flight Acceptance Composite Test.
- Bending mode test, 251
- Bickers, John H., 234
- Bilodeau, James W., 56
- Bioinstrumentation, 162, 166, 169, 177
blood pressure, 43
electrocardiogram, 43
equipment, 43
nuclear radiation dose, 43
oral temperature, 43
phonocardiogram, 43
respiration, 43
- Biomedical measurements, 43
blood pressure, 43
body temperature, 43
electrocardiogram, 43
electroencephalogram, 43
galvanic skin response, 43
phonocardiogram, 43
respiration, 43
- Bipropellant attitude and control system, 21
- Bipropellant thrusters, 16
- Blockhouse, 36
- Blood pressure. *See* Bioinstrumentation.
- Boilerplate spacecraft, 27, 43, 50, 55, 86, 90, 98, 104
Boilerplate No. 1, 79
Boilerplate No. 2, 98, 145
Boilerplate No. 3, 64
Boilerplate No. 3A, 131-132
Boilerplate No. 4, 138

INDEX

Boilerplate spacecraft—Continued
 Boilerplate No. 5, 90, 111, 129
 Boilerplate No. 201, egress trainer, 125, 161
 Boilerplate Flight Article 1A, 104
 Bomarc missile, 85
 Boone, Walter F., 103
 Boosters
 Atlas, 56
 Atlas-Agena B, 5, 14, 18, 22, 27, 44
 Atlas-Centaur, 11
See also names of each.
 Booster Facility Acceptance Composite Test (B-FACT), 202, 233, 240, 252, 258
 Borman, Frank, 60, 75, 106, 151, 204, 223, 224
 Bost, James E., 15
 Brackett, Ernest, 17
 Brooks Air Force Base, Texas, 49
 Brown, Harold, 7
 Budget, 35, 62
 Fiscal Year 1962, 7, 17
 Fiscal Year 1963, 85
 Buffalo, New York, 55
 Burbank, California, 32
 Burke, Walter F., 6, 10, 117, 121, 182, 217
 Burroughs Corporation, 26

C

C-130 aircraft, 90
 C-133 aircraft, 152
 C-band radar beacon, 38, 42, 51, 60, 101, 211
 Cabin atmosphere, 24, 158
 Cabin pressurization, 76, 80
 Camera, 141
 Canoga Electronics Corporation, 63
 Canoga Park, California, 63
 Cape Canaveral, Florida, 12, 15, 46, 53, 54, 55, 57, 58, 61, 65, 68, 74, 76, 77, 79, 80, 93, 96, 104, 121, 122, 125
 Cape Gemini/Agena Test Integration Working Group, 98
 Cape Kennedy, Florida, 126, 129, 135, 139, 140, 150, 152, 153, 155, 156, 159, 160, 163, 165, 169, 170, 175, 177, 179, 185-187, 189, 192, 197, 198, 202, 203, 208-211, 215, 216, 218, 220, 223, 229, 231-233, 235, 239, 240, 241, 243, 244, 246, 251, 253, 254, 257
 Capsule Review Board, 5
 Carley, Richard R., 29, 119
 Castor (star), 20
 Catapult, rocket, 32
 Cedar Rapids, Iowa, 36
 Center of gravity, 59, 79, 220
 Centrifuge, 27
 training program, 27, 92, 102, 162, 170
 Cernan, Eugene A., 119, 219, 234, 245-248
 Ceylon, 255
 Chaffee, Roger B., 119
 Chamberlin, James A., 6, 9, 11, 13, 15, 21, 24, 43, 53, 56, 62, 73, 75, 79, 84
 Chance Vought Corporation, 34
 Chesapeake Bay, 145
 Chest pack. *See* Extravehicular life support system.
 Chicago, Illinois, 41, 50, 121
 Chicago Midway Laboratories, 41
 China Lake, California, 48, 98, 146, 178
 Cincinnati, Ohio, 41
 Circular orbit, 63, 232, 239, 252
 Circumlunar flights, 18
 Circumlunar orbiting mission, 153
 CIT. *See* Combined Interface Test.
 Clean room, 212, 214
See also White room.
 Clements, H. E., 96
 Clickner, Russell E., 111

Cockpit stowage, 141, 248
 Cocoa Beach, Florida, 47
 Cohen, Haggai, 22
 Collins, Michael, 119, 204, 231, 248, 251
 Collins Radio Company, 34, 63
 Combined Interface Test (CIT), 198, 199, 240, 247, 252, 258
 Combined Systems Acceptance Test (CSAT), 94, 113, 114, 118, 142, 143, 153, 194, 203, 215, 218, 232, 240
 Combined Systems Tests, 105, 136, 164, 181, 202, 239, 243
 Command system (GATV), 186, 198, 205, 222, 230, 232, 238, 252
 Communications, 179, 222
 DOD support, 121
 system, 238
See also Gemini spacecraft systems and Spacecraft systems.
 Communications radiation test, 175, 176
 Complex 14, 55, 60, 66, 87, 89, 170, 184, 202, 205, 207, 215, 216, 229, 232, 234-236, 240, 241, 244, 247-249, 251, 252, 254, 258, 259
 Gemini-Agena facilities completed, 149
 Complex 16, 166, 185
 Complex 19, 15, 89, 93, 94, 118, 120, 127, 135, 136, 139, 151, 154, 155, 157, 159, 163, 164, 179, 181, 182, 184, 185, 189, 192, 194, 200, 202, 203, 205, 209, 211, 213, 216, 217, 219, 225, 226, 230, 232, 235, 239, 240, 245-247, 251-253, 255, 257-259
 Computer complex, 62
 Computer system, 23, 40, 62, 100, 102, 110, 126, 138, 143, 241
 digital computer, 40, 41, 86, 244
 incremental velocity indicator, 40
 launch programs, 170
 malfunction, 209
 manual data insertion unit, 40
 memory, 202, 206
 Congress, 1
 Conrad, Charles, Jr., 60, 75, 106, 184, 206, 209, 215, 239, 254
 Console controls and displays, 41
 Consolidated Steel, 47
 Contractors, Subcontractors, and Vendors. *See* Appendix 7.
 Control system, 22, 118
 Controlled land landing, 14, 18, 19
 Controlled reentry, onboard, 3, 71, 180, 202, 235, 237
 Coolant system, 171
 Cooper, L. Gordon, Jr., 183, 206, 209, 248
 Correale, James V., 64
 Cost of Gemini Program. *See* Appendix 5.
 Cress, Gordon P., xv, 64
 Crew compartment, 27
 Crew displays, 28
 Crew safety, 53
 Crew-station system, 24
 mock-up, 99, 145
 Crew Systems Division, 76, 126, 127, 131, 141, 143, 155, 161, 162, 171, 177, 192, 208
 Crew trainer, 146
 Crew training, 27, 167, 185
 Crowley, John W., 1
 Cryogenic Building, 156
 Cryogenic system, 12, 65
 oxygen, 98
 tanks, 98, 109
 CSAT. *See* Combined Systems Acceptance Test.
 CTL Division. *See* Studebaker Corporation.
 Cunningham, R. Walter, 119
 Cylindrical space laboratory, 5

D

- Dalby, James F., 52
 Dallas, Texas, 39, 63, 115
 Data acquisition system, 41
 "Data simulator," 145
 Data transmission system, 46, 85
 David Clark Company, Inc., 63, 96, 103, 127, 154
 Davis, Leighton I., 103, 121
 Day, LeRoy E., 177
 DCS. *See* Digital command system.
 Decker, James L., 12, 13
 Defecation gloves, 141
 Denver, Colorado, 80, 208, 213
 Department of Defense (DOD), 7, 19, 20, 61, 73, 74, 78, 82, 88, 103, 112, 121
 Director of Defense Research and Engineering, 7, 17, 18
 experiment D-12, 155
 experiments, 82, 114
 Representative for Project Gemini Operations, 103, 121
 support, 74
 Design Approval Tests, 108, 109
 Design Engineering Inspection, 50, 67, 71, 105, 114
 Design Information Tests, 109
 Design review meeting, 99, 215
 Detroit, Michigan, 83
 Development Engineering Inspection, 145
 "Development Plan for the Gemini Launch Vehicle System," 35, 61
 Development test vehicle (DTV), 142
 Digital command and communications subsystem, 42
 controller, 42
 onboard tape recorder, 42
 PCM telemetry, 42
 programmer, 42
 Digital command encoder, 63
 Digital command system (DOS), 34, 41
 Digital computer, 4, 35, 40
 Dineen, Richard C., 21, 79, 104, 119, 122
 Direct ascent, 17
 Disher, John H., 9
 Displays
 pilot, 92
 Docking, v, 18, 19, 86, 235, 245, 251, 255, 260
 trainer, 28, 85
 DOD. *See* Department of Defense.
 DOD Representative for Project Gemini Operations, 103, 121
 Donlan, Charles J., 5
 Dopheide, Neil C., 16
 Dorman, Bernhardt L., 116
 Douglas Aircraft Corporation, 123
 Downey, California, 8, 50
 Drogue-and-pilot-chute, 129
 Drogue parachute, 111
 stabilization, 129, 140
 Drop tests, 111, 138
 boilerplate, 100, 129
 qualification, 141
 Dryden, Hugh L., 40
 DTV. *See* Development test vehicle.
 Dust cap, 226
 Dye marker, 144
 Dynamic pressure, 90
 Dynamic stability, 67
 Dyna-Soar, 12
- E**
- Eagle-Picher Company, 72, 73
 Earth-orbital flights, 18
 Earth-orbital rendezvous, 5, 22
 Eastern Test Range (ETR), 143, 151, 154, 168, 170, 198, 205, 220, 230, 233, 240, 243, 244, 248, 253
 ECS. *See* Environmental control system.
 Edwards Air Force Base, California, 92, 120
 Edwards, John A., 176
 EEI. *See* Electronic-Electrical Interference Tests.
 Eggleston, John M., 4
 Egress tests, 144, 155, 182
 Ellington Air Force Base, 125, 155, 161, 162
 Galveston Bay, 158
 Egress trainer, 27, 155
 Eisele, Donn F., 119
 Ejection seat, 11, 18, 31, 32, 44, 49, 51, 59, 67, 68, 80, 94, 146, 161, 178, 184
 ballute, 68, 120, 184
 Ejection seat system, 31, 67, 91, 120, 132, 146, 147, 178, 184
 ballute, 120, 184
 Ejection tests 59, 64, 91, 98, 181, 184
 off-the-pad, 49, 51, 52, 59, 78, 91
 rocket sled, 49, 64, 151
 El Centro, California, 90, 123, 124, 129, 140, 144
 Electrical Interface Integrated Validation and Joint Guidance and Control Test, 194, 204, 213, 219, 233, 240, 248, 253, 258
 Electrical Interface Integrated Validation Test, 163, 184, 243
 Electrical power, 16, 73, 85, 151, 198, 205, 226, 238, 240, 247, 252
 Electrical storm, 154
 See also Weather.
 Electrical systems, 22, 105, 222
 Electrical Systems Coordination Meeting, 74
 Electrocardiogram. *See* Bioinstrumentation.
 Electromagnetic incident, 154, 156, 157
 Electromagnetic interference (EMI), 138, 182
 Electro-Mechanical Research, Inc., 46, 63, 114
 Electronic systems, 105, 185
 test unit, 63
 Electronic-Electrical Interference (EEI) Tests, 105, 113, 120, 136, 137, 142, 143, 159, 177
 Elkton, Maryland, 34
 Ellington Air Force Base, Texas, 161, 162
 water tank egress tests, 125, 161, 162
 Elliptical orbit, 63, 232, 251
 El Segundo, California, 23
 ELSS. *See* Extravehicular life support system.
 ELSS/AMU Joint Combined System Test, 241
 Emergency escape, 10, 32, 130, 185
 EMI. *See* Electromagnetic interference.
 Emme, Eugene M., xv
 Engineering and Contracts Division. *See* Space Task Group.
 Engineering and Development Directorate, Crew Systems Division. *See* Manned Spacecraft Center.
 Engineering change proposals, 68, 220, 257
 Engineering Division. *See* Space Task Group and Manned Spacecraft Center.
 Engines, 136, 149, 226
 Gemini-Agena Model 8427, 88, 89, 134, 218
 Model 8096, 88
 modified main engine (Agena), 220, 229-231
 multiple restart main (Agena), 23, 31, 55, 88, 89, 238
 second stage (GLV), 68
 sustainer, 184, 247
 vernier, 184, 243
 Environmental control system (ECS), 24, 25, 85, 98, 100, 186, 193, 194, 202, 208, 216
 Equipment section. *See* Gemini spacecraft.
 Erector, 46, 155, 199, 226
 Ertel, Ivan D., xiii, xv

INDEX

Escape system, 32, 59, 64, 98, 123, 176, 177
 backboard, 176, 184
 egress kit, 176, 184
 rocket catapult, 32, 59, 64, 178

Escape tower, 18

Escape velocity, 2

Estes, Howell M., Jr., 113

ETR. *See* Eastern Test Range.

Evans, W. B., 230

Experiments, 74, 135, 136, 151, 152, 154, 176, 191, 202, 210, 224, 227, 235, 237, 255, 259, 261
 DOD, 82, 114, 133, 155
 inflight military, 82
 results, 233, 261
 scientific, 152, 189, 230
See also Appendix 1.

External status displays, 23, 57, 143

Extravehicular
 activity, v, 154, 189, 192, 201, 205, 219, 230, 231, 235, 245, 248, 251, 254, 255, 258-261
 equipment, 197, 229, 231, 241, 251
 life support package, 123, 222, 230, 233
 life support system (ELSS), 151, 155, 162, 172, 182, 233, 239, 241, 245, 248
 chest pack, 151, 154, 162, 172, 182, 192
 operations, 6, 60, 76, 84, 123, 131, 176, 177
 pressurization and ventilation system, 132, 162
 suit, 196
 tests, 145, 241
 umbilical, 172, 182, 192, 197, 251, 255, 260
See also Appendix 1.

F

F-106 aircraft, 147, 181

FACI. *See* First Article Configuration Inspection.

Faget, Maxime A., 6

Failed Equipment and Discrepancy Reports, 146

FCMT. *See* Flight Configuration Mode Test.

Federal-Mogul Corporation, 38
 Arrowhead Products Division, 38

Ferrando, James A., 53

Final Simulated Flight Test, 195, 235

Final Systems Test, 205, 219, 233, 241, 248, 253, 258

Final Vehicle Systems Test, 125

First Article Configuration Inspection (FACI), 195, 198, 217

Fisher, Lewis R., 136

Flammability test, 126

Flashing light, 42, 71, 86

Flight Configuration Mode Test (FCMT), 164, 177, 184, 194, 204, 213, 217

Flight controllers, 24, 55, 56
 command site teams, 55
 network training, 55
 procedures, 76
 remote site teams, 55
 training, 55, 94

Flight Crew Operations Directorate, 131

Flight Crew Operations Division, 32, 91, 122, 141, 192
 Spacecraft Operations Branch, 27

Flight Crew Support Division, 151, 152, 155, 161

Flight crews, 27, 32, 106, 145, 151, 160, 161, 165, 170, 185, 192, 204, 208, 209, 215, 219, 231, 239, 247, 248

Flight medical kit, 141

Flight Operations Directorate, 149

Flight Operations Division, 23, 52, 53, 55, 71, 73, 122, 176, 232
 Flight Control Operations Branch, 55
 Rendezvous Analysis Branch, 98

Flight program, 27, 100

Flight Research Center (FRC), 4, 17, 41, 67, 71, 92

Flight simulator, 27

Flight Systems Division (FSD), 2, 4
 Aerodynamics Section, 4

Florida peninsula, 210

Flotation collar, 144, 191

Flotation tank, 155, 161, 162

Flotation test, 104

Follow-on experiments, 2
 14-day mission, 2
 lunar orbit reentry, 2
 maneuver in orbit, 2
 manned reconnaissance, 2
 self-contained guidance, 2
 touchdown control, 2
See also names of each.

Follow-on Mercury program, 2, 5

Food, 50

Food and waste management system, 50, 141, 169

Food storage, 50

Fourteen-day mission, 2

Fowler, William D., 50

Frank, M. P., 76

FSTV. *See* Full-scale test vehicle.

Freeman, Theodore C., 119

Fuel, 158, 159, 168, 218, 251
 requirements, 122

Fuel cells, 16, 21, 22, 33, 74, 75, 101, 109, 126, 139, 151, 153, 157, 158, 178, 179, 193, 197, 205, 209, 210, 216, 220, 232, 235, 246
 development, 104, 117, 121
 gas-diffusion electrodes, 21, 22
 ion-exchange membranes, 21, 75
 life, 117
 operating temperatures, 117
 section, 151, 197, 253
 stack, 74, 75, 226, 257, 261

Fuel-oxidizer system, 65, 121, 133

Full-scale flight test vehicle, 30, 54

Full-scale paraglider wing, 27-28, 50-51, 118-119

Full-scale test vehicle (FSTV), 50, 55, 87, 90, 100, 105, 115, 130, 168

Funk, Ben I., 119, 133, 193, 216

G

Galveston Bay, 98, 122, 139, 158

Gantry, 46

Gardena, California, 38

Gardner, A. J., 220

Garrett Corporation, 24, 123, 132

GATV. *See* Gemini Agena target vehicle.

GATV 5001. *See* Gemini Agena target vehicle (GATV) 5001.

GATV 5002. *See* Gemini Agena target vehicle (GATV) 5002.

GATV 5003. *See* Gemini Agena target vehicle (GATV) 5003.

GATV 5004. *See* Gemini Agena target vehicle (GATV) 5004.

GATV 5005. *See* Gemini Agena target vehicle (GATV) 5005.

GATV 5006. *See* Gemini Agena target vehicle (GATV) 5006.

GATV Review Board, 216, 220

Gemini (constellation), 20

Gemini (project), v, 60
 named, 20

Gemini VI, 216, 217, 218
Gemini VI-A, 227, 228
 launch, 227
 spacecraft, 224, 228
 abort, 226

PROJECT GEMINI: A CHRONOLOGY

- Gemini VII*, 204, 205, 208, 217, 219, 222-224, 226, 228
 launch, 224
- Gemini VIII*, 215, 220, 221, 229-231, 235-239, 248, 251
 launch, 235
- Gemini IX*, 155, 219, 229, 230, 232-234, 239
 launch postponed, 243
 redesignated *Gemini IX-A*, 243
- Gemini IX-A*, 247
 launch, 245
 target, 232, 244, 245
- Gemini X*, 231, 232, 239, 241, 247-249, 251, 252
 launch, 251, 255
- Gemini XI*, 232, 239, 241, 250, 252-257
 launch, 254
 rendezvous target, 252
- Gemini XII*, 232, 241, 247, 258-260
 launch, 259
 target vehicle, 243
- Gemini Abort Panel*, 86, 94
See also Abort Panel.
- Gemini-Agena propulsion development plan*, 62
- Gemini/Agena rendezvous and docking equipment development*, 19
- Gemini Agena target vehicle (GATV)*, 53, 86-88, 112, 125, 137, 141, 170, 186, 193, 215, 221, 232, 235, 237, 252, 260
- Gemini Agena target vehicle (GATV) 5001*, 142, 143, 157, 164, 167, 179, 181, 187, 188, 191, 198, 207, 217, 220, 227, 243, 252, 253, 257, 258
 FACI, 195, 198, 217
 parking, 237, 255, 260
 systems tests, 195, 205
- Gemini Agena target vehicle (GATV) 5002*, 170, 171, 195, 197, 203, 205, 207, 211, 213, 215, 216, 218, 219, 220, 239
 mission failure, 216, 239
 shipped to ETR, 205
- Gemini Agena target vehicle (GATV) 5003*, 206, 216, 220, 229-232, 234, 238, 239
- Gemini Agena target vehicle (GATV) 5004*, 226, 231-233, 239-241, 243, 244
- Gemini Agena target vehicle (GATV) 5005*, 232, 240, 243, 244, 247, 248, 252
- Gemini Agena target vehicle (GATV) 5006*, 239, 246, 248, 251-253
- Gemini Agena Target Vehicle Management-Technical Review*, 191
- Gemini Agena Target Vehicle Modification and Test Program*, 220
- Gemini Atlas-Agena target vehicle* 205, 215, 216, 235, 236, 249, 251, 254, 259
- "*Gemini Atlas Agena Target Vehicle Systems Management and Responsibilities Agreement*," 193
- Gemini Configuration Control Board*, 152
- Gemini Extra Care Program*, 146
- Gemini facilities*, 66
- Gemini flight program*, 80, 82, 160
 revised, 62, 87, 92
- Gemini launch schedules*, 61, 62, 121, 157, 184, 205, 209, 217, 219, 226, 235, 241, 244, 248, 254
- Gemini launch vehicle (GLV) 19*, 34, 36, 46, 51, 52, 61, 66, 68, 80, 82, 93, 94, 130, 139, 169, 170, 178
 contract for, 147
 fixes on Titan II flights, 68, 125
 flight control subsystem, 24, 26
 manufacturing and testing. *See* Appendix 3.
 propellant tank, 80, 81
 skirt assemblies, 80
- Gemini launch vehicle (GLV) 1*, 80, 90, 105, 113, 114, 128, 135, 139
 airlifted to AMR, 120
 CSAT tests, 113, 118, 127
 mechanical mate, 136
- Gemini launch vehicle (GLV) 1—Continued*
 stage I, 94, 120, 127, 155
 stage II, 94, 95, 120, 127, 155
 VAT, 127
- Gemini launch vehicle (GLV) 2*, 100, 114, 125, 126, 132, 142, 143, 151, 154, 156, 157, 159, 167, 169
 arrived at ETR, 143, 152
 electrical mate, 164
 engines, 125
 mechanical mate, 163
 stage I, 151, 152, 169
 stage II, 80, 100, 151
 tandem actuators, 169, 176
- Gemini launch vehicle (GLV) 3*, 126, 153, 156, 159, 160, 167, 181, 182
 acceptance, 160
 mechanical mate, 182, 184
 stage I, 149, 167
 stage II, 167
- Gemini launch vehicle (GLV) 4*, 136, 162, 167, 192
 engines, 137
 mechanical mate, 194
 roll-out inspection, 187
 shipped to Cape Kennedy, 187
 stage I, 137, 187
 stage II, 137, 187
- Gemini launch vehicle (GLV) 5*, 149, 183, 193, 194, 202
 mechanical mate, 205
 modifications, 183
 stage I, 183, 194
 stage II, 183, 194
 shipped to Cape, 194
- Gemini launch vehicle (GLV) 6*, 170, 171, 193, 203, 217
 engines, 171
 mechanical mate, 213
 stage I, 203, 211, 226
 stage II, 203, 211, 226
 tanks, 154, 170, 171
- Gemini launch vehicle (GLV) 7*, 215
 airlifted to Cape Kennedy, 215
 electrical mate, 219
 engines, 185
 mechanical mate, 219
 stage I, 203, 215, 217
 stage II, 203, 215, 217, 219
 tanks, 185
- Gemini launch vehicle (GLV) 8*, 193, 215, 217, 218, 220, 233, 235
 airlifted to Cape Kennedy, 218
 electrical mate, 233
 engines, 193, 230
 stage I, 193, 218
 stage II, 193, 219, 230
 tanks, 193
- Gemini launch vehicle (GLV) 9*, 208, 226, 232, 239, 241
 electrical mate, 240
 engines, 208
 stage I, 208, 233
 stage II, 208, 233
 tanks, 208
- Gemini launch vehicle (GLV) 10*, 213, 218, 231, 240, 246
 electrical mate, 248
 engines, 220
 mechanical mate, 248
 stage I, 213, 220, 234, 241
 stage II, 213, 220, 234, 241
 tanks, 213, 220
- Gemini launch vehicle (GLV) 11*, 218, 231, 246, 247, 252
 electrical mate, 253
 engines, 218
 mechanical mate, 253
 stage I, 218, 241, 246, 247
 stage II, 218, 241, 246, 247
 tanks, 218, 220

- Gemini launch vehicle (GLV) 12, 218, 248, 253, 257
 electrical mate, 258
 engines, 231
 mechanical mate, 258
 stage I, 231, 248, 253
 stage II, 218, 231, 248, 253
 tanks, 218, 231
- Gemini launch vehicle (GLV) 13, 153
- Gemini launch vehicle (GLV) 14, 153
- Gemini launch vehicle (GLV) 15, 153
- Gemini Launch Vehicle Configuration Control Board, 68
- Gemini Launch Vehicle Directorate, 21
- Gemini Launch Vehicle Pilot Safety Program, 79
- Gemini Launch Vehicle Program, 23
- Gemini Launch Vehicle Program Office, 23, 115
- Gemini Management Panel, 79, 83, 89, 100, 121, 133, 142, 157, 182, 194
- "Gemini Manufacturing Plan," 39
- Gemini Midprogram Conference, 233
- Gemini mission planning, 111
- Gemini mission simulator, 27, 146, 165
 No. 1, Cape Kennedy, 126, 163, 165
 No. 2, Houston, 162, 167
- Gemini Network Operations Directive 63-1, 96
- Gemini Operational and Management Plan, 19, 21
 DOD responsibilities, 19
 NASA responsibilities, 19
- Gemini Operations Support Committee, 53
- Gemini Phase I Centrifuge Program, 102
- Gemini Procurement Office, 48, 135
- Gemini Program, v, vi, xiii, 21, 32, 42, 44, 54-56, 61, 62, 78, 82-84, 86-88, 96, 108, 125, 135, 155, 156, 160, 167, 168, 170, 200, 208, 224, 227, 232, 239, 240, 245, 247
- Gemini Program and Mission Objectives. *See* Appendix 2 and Appendix 8.
- Gemini Program Flight Summary Data. *See* Appendix 1.
- Gemini Program Instrumentation Requirements Document (PIRD), 61
- Gemini Program Mission Planning Report, 176
- Gemini Program Office, xiii, xv, 146, 151, 153, 155, 161, 170, 176, 181, 182, 188, 191, 208, 211, 222, 230, 257
- Gemini Program Planning Board, 78, 82, 84, 90, 125
- Gemini Project Manager, 24, 84
- Gemini Project Office, 21, 24, 30-32, 39, 42-44, 46, 48, 51-53, 55, 57, 58, 62, 64, 65, 73, 75, 79-81, 83, 87, 91, 96, 98, 99, 101-104, 108, 109, 116, 121, 126, 131, 135, 136, 142, 159
 Manager, 21, 89, 100
 Systems Integration Office, 136
- Gemini Pyrotechnic Ad Hoc Committee, 110
- Gemini Recovery School, 149
- Gemini Rendezvous and Reentry Panel, 76
- Gemini spacecraft, 20-261, *passim*
 adapter section, 26, 33, 84, 100, 182, 188, 194, 196, 203, 213, 261
 boilerplate, 27
 checkout, 80
 communications and electrical system, 35, 36, 43
 configuration, 37
 cost, 44, 85
 design, 30
 development, 19, 43
 engineering mock-up, 56, 57, 103
 equipment section, 204
 instrument and recording system, 43, 100
 maneuvering system, 26, 27, 29, 41, 89
 manufacturing and testing. *See* Appendix 3.
 reentry section, 90, 92, 179, 182, 188, 194, 203, 213
 rendezvous and recovery section, 27, 179
 schedule, 21, 39, 43
- Gemini Stability Improvement Program, 116
- Gemini Summary Conference, 261
- Gemini Target Management Review Meetings, 86
- Gemini Target Vehicle Program, 73, 220
 Director, 220
- Gemini-Titan, 53, 79
- Gemini-Titan 1 (GT-1)*, 104, 111, 121, 122, 129, 137, 142
 launch, 139
- Gemini-Titan 1A (GT-1A)*, 104, 122
- Gemini-Titan 2 (GT-2)*, 111, 122, 142, 150, 157, 158, 165, 169, 170, 176-178, 179
 launch, 179
 mission objectives, 179
 scrubbed, 169
- Gemini-Titan 3 (GT-3)*, 111, 122, 127, 142, 154, 156, 157, 159, 161, 165, 166, 170, 176, 177, 181, 184-187, 189, 194
 launch, 189
 launch profile, 147
 mission objectives, 189-191
- Gemini-Titan 4 (GT-4)*, 127, 131, 157, 158, 161, 167, 170, 176, 177, 184, 192, 194, 197, 199, 201, 211, 231
 flight profile, 122, 151, 152, 192, 200-202
 launch, 200
 objectives, 200-202
 rendezvous evaluation experiment, 122, 151
 Simulated Flight Test, 196
 Wet Mock Simulated Launch, 196
- Gemini-Titan 5 (GT-5)*, 127, 131, 151, 157, 184, 194, 203, 205, 206, 209, 211
 launch, 209
 Wet Mock Simulated Launch, 205, 206
- Gemini-Titan 6 (GT-6)*, 131, 148, 151, 157, 177, 187, 192, 205, 207, 213, 215
 launch schedule, 177
See also Gemini VI.
- Gemini-Titan 7 (GT-7)*, 131, 151, 157
See also Gemini VII.
- Gemini-Titan 8 (GT-8)*, 131
See also Gemini VIII.
- Gemini-Titan 9 (GT-9)*, 131
See also Gemini IX.
- Gemini-Titan 10 (GT-10)*, 131
See also Gemini X.
- Gemini-Titan 11 (GT-11)*, 131
See also Gemini XI.
- Gemini-Titan 12 (GT-12)*, 131
See also Gemini XII.
- Gemini-Titan Coordination Meeting, 44
- Gemini-Titan Launch Operations Committee, 53
- General Dynamics/Astronautics, 14, 149
- General Dynamics/Convair, 168, 229, 246
- General Electric Company, 21, 22, 26, 116
- General Electric Mod III G, 75
 radio guidance system, 26, 75
- Gilruth, Robert R., 2, 6, 8, 9, 12, 13, 15, 17-19, 21, 60, 62, 83, 139, 141, 192, 193, 208, 209, 216, 217, 222, 247, 261
- GLV. *See* Gemini launch vehicle.
- Goddard Space Flight Center, 24, 42, 63, 96, 140, 160, 184
- Goett committee, 1
- Goett, Harry J., 1
- Goodrich, B. F., Company, 38, 63, 64
 Aerospace and Defense Products Division, 37
- Goodwin, Harold L., 20
- Goodyear Aircraft Corporation, 8, 30
- Gordon, Richard F., Jr., 119, 215, 239, 254, 255
- Gravity-gradient stabilization, 261
- Greenbelt, Maryland, 24
- Grimwood, James M., xiii, xv, 21, 61, 154
- Grissom, Virgil I., 141, 160, 165, 185, 189, 190, 192
- Ground controllers, 27, 202, 252
- Ground instrumentation equipment, 154, 244
- Ground stations, 35, 36, 38, 53
- GT-1. *See* Gemini-Titan 1.

GT-1A. *See* Gemini-Titan 1A.
 GT-2. *See* Gemini-Titan 2.
 GT-3. *See* Gemini-Titan 3.
 GT-4. *See* Gemini-Titan 4.
 GT-5. *See* Gemini-Titan 5.
 GT-6. *See* Gemini-Titan 6 and Gemini VI.
 GT-7. *See* Gemini-Titan 7 and Gemini VII.
 GT-8. *See* Gemini-Titan 8 and Gemini VIII.
 GT-9. *See* Gemini-Titan 9 and Gemini IX.
 GT-10. *See* Gemini-Titan 10 and Gemini X.
 GT-11. *See* Gemini-Titan 11 and Gemini XI.
 GT-12. *See* Gemini-Titan 12 and Gemini XII.
 Guidance and control equipment, 140, 194, 222, 258
 Guidance and control system, 1, 22, 33, 40, 42, 71, 102,
 169, 194, 222, 258
 secondary, 3, 169
 Gulf of Mexico, 185
 Guy, Walter W., 64

H

HAET. *See* High-Altitude Ejection Test.
 Half-ring flaps, 4
 Half-scale flight test vehicle, 30, 48, 49
 Half-scale test vehicle (HSTV), 41, 56, 66, 83
 Half-scale tow test vehicle (HSTTV), 90, 92
 helicopter-towed paraglider, 3
 Hall, Albert C., 8
 Handcontroller, 92
 Hand-held maneuvering unit (HHMU), 192, 196, 197,
 202, 203
 Hangar AF, 58, 66, 117
 Hangar E, 198, 205, 211, 213, 220, 232, 240, 244, 252,
 257
 Hangar J, 184, 202, 207
 Hangar L, 241
 Hangar S, 57, 58, 65
 Hangar T, 253
 Hangar U, 246
 Hannigan, James E., 87
 "Hard start," 218, 219, 239
 Harness, Armita, 31
 Harris, Howard T., xv, 18
 Hasson, Dennis F., 4
 Hatch, ii, 32, 43, 49, 75, 80, 103, 158, 202, 230, 245, 246,
 251, 254
 actuation system, 32, 146, 178
 Heat, 158, 179
 Heat exchangers, 33
 Heat transfer, 5
 Heatshield, 4, 41, 51, 64, 65, 100, 111, 150, 161, 244
 qualification tests, 84, 146
 Hecht, K., 50
 Heimstadt, C. E., xv, 64
 Helicopter, 28, 56, 66, 93, 153, 189, 190, 202, 257, 261
 Helmet, 103
 Heller, N. R., 43
 Hello, Bastian, 13, 15
 HF voice transceiver, 36
 HHMU. *See* Hand-held maneuvering unit.
 High-Altitude Ejection Test (HAET), 181, 184
 High Speed Flight Station, 17
 Hill, Raymond D., 217
 Hjernevik, Wesley L., 62
 Hoffman, J., 36
 Hohmann, Bernhard A., xv, 133, 154, 220
 Holmes, D. Brainerd, 16, 17, 20, 40, 83, 85, 90, 220
 Horizon sensor, 33
 House Committee on Science and Astronautics, 1, 7, 85
 Subcommittee on Manned Space Flight, 85, 86
 Houston, Texas, 18, 23, 24, 45, 53, 55, 62, 119, 125, 129,
 139, 167, 170, 193
 Hudson, John B., 193, 218, 220
 Hueter, Hans, 73

Humidity, 158
 Huntington Beach, California, 119
 Huntsville, Alabama, 22
 Hurricane
 Betsy, 213
 Cleo, 155, 156
 conditions, 157
 Dora, 155
 Ethel, 155
 Hilda, 158
 Isbell, 159
 Huss, Carl R., 71, 73
 Hutchison, F. M., 156
 Hydrogen, 33
 Hypergolic propellants, 177, 248

I

IBM. *See* International Business Machine Corporation.
 Improved Mercury, 7
 IMU. *See* Inertial measuring unit.
 Incremental velocity indicator, 40
 India, 255
 Inertial guidance system, 26, 37, 102, 110, 122, 138, 143
 Inertial measuring unit (IMU), 36, 100
 Inertial platform, 34, 41, 43, 92, 138
 stabilized, 36
 Ingress test, 182
 Instrument pallets, 101, 116, 117, 150
 Instrument panel, 97
 Instrumentation, 51, 222
 Instrumentation and Electronic Systems Division, 112,
 113, 157
 Integrated Mission Control Center, 62, 84
 See also Mission Control Center.
 Integrated Systems Test, 109
 Interferometer, 85
 International Business Machines Corporation (IBM)
 24, 40, 44, 52, 62, 84, 92, 102
 Space Guidance Center, 40
 Ionization zone, 51

J

J-1 computer, 111
 Jeffs, George W., 58
 Jet Propulsion Laboratory (JPL), 4
 J-FACT. *See* Joint Flight Acceptance Composite Test.
 Johnson, Caldwell C., 4
 Johnson, Harold I., 27, 28
 Johnston, Richard S., 64, 192
 Johnsville, Pennsylvania, 27, 102
 Joint Combined Systems Test, 164, 167, 184, 219, 233,
 240, 248, 253, 258
 Joint Flight Acceptance Composite Test (J-FACT),
 215, 234, 235, 241, 248, 253, 259
 Joint Guidance and Control Test, 163, 184, 205
 Joplin, Missouri, 72
 JPL. *See* Jet Propulsion Laboratory.

K

KC-135 aircraft, 92, 145, 164, 177
 Kapryan, Walter J., 217
 Kehlet, Alan B., 2, 4
 Kennedy Space Center, 193
 pad operations, 193
 Kindley Air Force Base, Bermuda, 149
 Kleinknecht, Kenneth S., 145, 151
 Kline, Robert L., 31, 83
 Kraft, Christopher C., Jr., 56, 148, 176, 184, 209
 Kranz, Eugene F., 56
 Kuraz, Alexander C., 177

INDEX

- L**
- L-band radar target, 71
 L-band tracking radar, 143
 Laboratory, 6
 Land impact test, 90, 106
 Land landing, 2, 27, 30, 87, 109
 Landing, 226, 229
 Landing and Recovery Division, 144, 149
 Landing gear, 30
 Landing point, 189, 194, 226, 229, 237, 252, 257, 261
 accuracy, 189, 226, 229, 237, 246, 252, 257, 261
 Landing rocket system, 109
 control system, 109
 drogue parachute, 109
 landing rocket, 109
 parasail, 109
 retrorocket, 109
 Lang, Dave W., 83
 Langley Field, Virginia, 1
 Langley Research Center, 2, 4, 13, 17, 41, 67, 71, 144, 152
 wind tunnel tests, 5
 Large Launch Vehicle Planning Group (LLVPG), 17
 Launch
 DOD support, 121
 Launch Guidance and Control Coordination Meeting, 75
 Launch Operations Building, 149
 Launch Operations Center, 74
 Launch pad, 32, 225
 Launch Preparations Group (LPG), 129, 145
 Launch schedules, 14, 15, 21, 27, 43
 Launch vehicle adapter, 19
 Launch vehicle autopilot, 41
 Launch Vehicle Spacecraft Interface Working Group, 44
 Launch vehicle systems, 39, 137, 154, 163, 233
 Launch vehicles, 19
 Atlas, 12, 13, 14, 18, 73, 108
 Atlas-Agena B, 5, 14, 18, 22, 27, 44
 Atlas-Centaur, 11
 Nova, 11
 Saturn, 73
 Saturn C-3, 11
 Titan II, 8, 15, 74
 Titan II-1/2, 17
 Titan III, 17
 See also names of each.
 Launch windows, 83, 101
 Lenticular vehicle, 4
 Letsch, Ernst R., 182
 Lewis Research Center, 2, 4, 73, 86
 Life raft, one-man, 185
 Life Systems Division, 32, 43, 48, 50, 60, 63
 Lifeboat rescue mission, 153
 Lift capability, 194
 Lift-over-drag ratio, 4, 5
 Lifting Mercury, 5
 Lightning strike, 154, 156, 157
 electromagnetic incident, 154
 See also Weather.
 Lindley, Robert N., 19, 24, 102
 Ling-Temco-Vought, Inc., 115, 147, 162
 LLVPG. *See* Large Launch Vehicle Planning Group.
 Lockheed Missiles and Space Company, 14, 31, 41, 42, 52-55, 61-63, 76, 86, 92, 112, 125, 133, 134, 138, 142, 143, 146, 148, 149, 157, 164, 167, 185, 191, 193, 203, 209, 213, 218-220, 227, 229, 239, 243
 systems test complex C-10, 157, 164, 182, 187, 188, 197, 240, 243, 248, 252
 Lockheed Super Constellation, 145
- Long-duration mission, 5, 14-16, 18, 49, 57, 63, 87, 151, 224
 GT-4, 151, 200
 GT-5, 209
 Gemini VII, 151, 222
 Longitudinal oscillations (POGO), 68, 76, 77, 82, 84, 85, 89, 90, 93, 103, 121, 125, 140
 fix, 68, 78, 85, 93
 Los Alamitos, California, 38
 Los Angeles, California, 24, 55, 60, 87, 119
 Lovell, James A., Jr., 60, 75, 106, 151, 204, 223, 224, 231, 239, 247, 259
 Low dynamic pressure, 78
 Low, George M., 9, 14, 20, 62, 75, 86, 133, 135, 181, 192, 209
 LPG. *See* Launch Preparations Group.
 "Lunar-lander," 11, 12
 Lunar landing program, 8, 18
 Lunar orbit reentry, 2
 Lunar-orbit-rendezvous, 11, 86
 Lunar Orbiter Program, 257
 Lunar orbiting mission, 153
 Lunar reconnaissance, 5
 Lunar surface, v
- M**
- McDivitt, James A., 60, 75, 106, 151, 161, 162, 167, 195, 200, 202
 McDonnell Aircraft Corporation, 2-257, *passim*
 McGuire, Frank, 88
 McKee, Daniel D., 17, 19
 McMillan, Brockway M., 83, 114
 McNamara, Robert S., 17, 18, 73, 74, 83, 87, 88
 MacDougall, George F., Jr., 66, 68, 261
 Maggin, Bernard, 7
 Malfunction detection system (MDS), 22, 39, 51, 52, 97, 108, 140
 Maneuver in orbit, 2, 3, 210, 227, 229, 245, 251, 260
 Maneuverable Mercury spacecraft, 2, 6
 Manned circumlunar mission, 5
 Manned lunar landing, 17
 Manned maneuvering unit backpack, 219
 Manned orbital flight, v, 18, 87, 122, 160, 189, 224
 Manned orbiting laboratory, 78
 Manned reconnaissance, 2
 Manned space exploration, 14
 Manned space flight, v, 1, 5, 6, 13, 15, 38
 Manned space flight design certification review, 186
 Manned Space Flight Experiments Board, 135
 Manned Space Flight Network, 61
 Manned space flight summary. *See* Appendix 8.
 Manned Space Flight Tracking Network, 63, 160, 184
 Manned space laboratory, 1
 Manned Spacecraft Center (MSC), xiii, xiv, 15-261, *passim*
 Crew Systems Division, 76, 126, 141, 143, 177
 Engineering and Development Directorate, 177
 Engineering Division, 21
 Flight Crew Operations Directorate, 131
 Flight Crew Operations Division, 27, 32, 91, 122, 141, 192
 Spacecraft Operations Branch, 27
 Flight Crew Support Division, 151, 152, 155, 161
 Flight Operations Directorate, 149
 Flight Operations Division, 23, 52, 53, 55, 71, 73, 122, 176, 232
 Flight Control Operations Branch, 55
 Rendezvous Analysis Branch, 98
 Gemini Program Office, xiii, xv, 146, 151, 153, 155, 161, 170, 176, 181, 182, 188, 191, 208, 211, 222, 230, 257, 261

PROJECT GEMINI: A CHRONOLOGY

- Manned Spacecraft Center (MSC)—Continued
 Instrumentation and Electronic Systems Division, 112, 113, 157
 Landing and Recovery Division, 144, 149
 Life Systems Division, 32, 43, 48, 50, 60, 63
 Mission Planning and Analysis Division, 176, 178
 Procurement and Contracts Division, 154
 Propulsion and Power Division, 153
 Spacecraft Technology Division, 84
 Systems Evaluation and Development Division, 109, 111
 Landing and Impact System Section, 109
 Technical Services Division, 111
 Manned Spacecraft Center-Atlantic Missile Range Operations Office, 96
 Manned spacecraft development center, 7
 Manned Spacecraft Paraglide Landing System, 8
 Manual data insertion unit, 40
 Marine Corps. *See* United States Marine Corps.
 Mariner spacecraft, 60
 Mark II, 13, 14, 17-20
 project development plan, 13, 14, 17
 Marshall Space Flight Center (MSFC), 4, 22, 27, 31, 52, 53, 54, 73, 136
 Martin-Baltimore, 14-248, *passim*
 functional test stand, 51, 52
 horizontal testing 208, 218, 220, 231, 234, 241
 vertical test facility, 61, 93-95, 113, 160, 162, 167, 177, 183, 193, 194, 203, 215, 227, 232, 234, 241, 248
 Martin Company, 8, 12, 13, 15, 24, 39, 44, 52, 62, 73, 76, 79, 80, 122, 147, 153, 156, 167, 207, 217
 Martin-Denver, 80, 100, 126, 136, 149, 154, 185, 193, 208, 213, 218, 231
 Martin-Marietta Space Systems Division, 14
 Master Operations Control Set, 226
 Mathews, Charles W., vi, 84, 89, 100, 104, 110, 117, 121, 122, 135, 136, 145, 151, 157, 182, 193, 194, 205, 207, 208, 222, 241
 Maximum dynamic pressure, 49, 67, 79, 146
 May, H. E., 96
 Maynard, R. S., 83
 MDS. *See* Malfunction detection system.
 Mechanical Systems Coordination Meeting, 44, 45, 61, 65
 Medical assistance, DOD support, 121
 Melbourne, Florida, 63
 Mercury astronauts, 18, 39
 Mercury-Atlas, 12, 79, 94
 Mercury-Atlas 4, 51
 Mercury-Atlas 5, 51
 Mercury-Atlas 6, 51
 Mercury-Atlas 7, 51
 Mercury-Atlas 8, 51
 Mercury-Atlas 9, 76
 Mercury capsule, 1, 9, 18
 Mercury configuration modification, 4
 afterbody, 4
 landing systems, 4
 retro-escape system, 4
 Mercury flights, 24, 290
 Mercury Mark II, xvi, 13-17, 19
 detailed specification, 16
 aerodynamic shape, 16, 18
 heatshield, 16
 impact bag, 16
 spacecraft-launch vehicle adapter, 16
 tractor rocket escape tower, 16
 redesignated "Gemini," 20
 Mercury Network Operations Directive 61-1, 96
 Mercury program, v, 1, 7, 20, 32, 35, 51, 75
 Mercury Project Office, 55, 110, 111
 Mercury spacecraft, xvi, 2, 3, 5, 7, 10, 11, 12, 13, 16, 85
 Mercury-Titan program, 12
 Merritt Island, Florida, 65, 66, 185
 Merritt Island Launch Area (MILA), 74, 208-258, *passim*
 Merritt Island Launch Area Fluid Test Complex, 156
 Cryogenic Building, 156
 Merritt Island Launch Area Radar Range, 175, 239
 Boresight Tower, 79, 98
 Mesa, Arizona, 32
 Meyer, Andre J., Jr., 24, 65, 83
 Michel, E. L., 50
 Micrometeorite collection package, 251, 259
 MILA. *See* Merritt Island Launch Area.
 Minimum change capsule, 10
 "Minimum cost manned space station," 5
 Minneapolis-Honeywell Regulator Company, 29, 63, 89
 Aeronautical Division, 36, 83
 Minneapolis, Minnesota, 29
 Minners, Howard A., 102
 Missile Assembly Building, 155, 198
 Missile tracking and measurement system (MISTRAM), 111
 Mission Control Center, 27, 53, 54, 160, 184, 193, 228
 Cape Kennedy, 170, 205, 244
 Houston, 170, 205, 209, 228
 Integrated Mission Control Center, 62, 84
 Mission planning, 6
 Mission Planning and Analysis Division, 176, 178
 Mission Planning and Guidance Analysis Coordination Group, 57, 59
 Mission Planning Coordination Group, 111, 119
 Mission simulator, 85
 MISTRAM. *See* missile tracking and measurement system.
 Mitros, Edward F., 159
 MMU. *See* Modular Maneuvering Unit.
 Mock-up review, 56, 57, 59
 Modified Electrical Interface Integrated Validation, 205
 Modified Mercury spacecraft, 2, 3, 8
 Modified Titan II, 14, 18
 Modular Maneuvering Unit (MMU), 155, 230
 Modular systems design, 19
 Modularized equipment, 14
 Moffett Field, California, 1
 Morse, Mary Louise, xiii
 Motorola, Inc., 34
 Western Military Division, 34
 Mountain View, California, 33
 Moyers, William D., 217
 MSC. *See* Manned Spacecraft Center.
 MSC-Florida Operations, 139
 MSC-Gemini PCM Instrumentation Working Group, 42
 MSFC. *See* Marshall Space Flight Center.
 Mueller, George E., 53, 135, 137, 151, 177, 192, 204, 216-218, 222, 258
 Muhly, William C., 13
 Multimanned vehicle, 5

N

- Nagy, Alex P., 20
 NASA Centers and Other Government Agencies Participating in the Gemini Program. *See* Appendix 6.
 NASA-DOD Gemini Program Planning Board, 74
 NASA Half Scale Test Vehicle Design Review Board, 41
 NASA Headquarters, 5-9, 13, 15, 17-19, 27, 85, 87, 92, 104, 109, 127, 145, 158, 176, 208, 222, 234
 Gemini Program Office, 205
 Procurement Office, 181
 See also National Aeronautics and Space Administration.
 NASA-McDonnell Management Panel, 154, 208, 230

INDEX

NASA-MSC Florida Operations, 129
 Assistant Manager for Gemini, 129
 National Aeronautics and Space Administration (NASA), xiii, xiv, xv, 1, 4, 6, 8, 11, 15, 19, 20, 24, 39, 41, 55, 56, 62, 65, 67, 71, 73-75, 80, 82-85, 88-90, 92, 94, 99, 103, 104, 115, 125, 135, 143, 153, 156, 168, 195, 216, 217, 248, 258
 Administrator, 17, 44, 53, 73, 74, 83, 217
 Associate Administrator, 8, 15, 17, 18, 87, 135, 137, 192, 216, 222
 Associate Administrator for Manned Space Flight, 133, 135, 137, 151, 177, 192, 204, 216, 218, 258
 Deputy Administrator, 40
 Director of Aeronautical and Space Research, 1
 Director of Launch Vehicle Programs, 7
 Director of Launch Vehicles and Propulsion, 16
 Director of Manned Space Flight, 16, 17, 20, 85
 Director of Space Flight Development, 1
 Office of Manned Space Flight, vi, 16, 62, 75, 86, 177, 181
 Office of Space Flight Programs, 8, 13
 Naval Air Development Center, 27, 92, 102
 Naval Ordnance Test Station, 48, 51, 64, 78, 178
 Naval Parachute Facility, 124
 Navigation system, 4, 23, 209
 digital computer, 4
 stable platform, 4
 star tracker, 4
See also names of each.
 Navy. *See* United States Navy.
 Network Coordination Meeting, 79
 New Projects Panel, 2
See also Space Task Group.
 Nitrogen, 233
 Nold, Winston D., 7
 North American Aviation, Inc., 8, 9, 16, 17, 27, 30, 41, 48, 50, 51, 53, 55, 56, 58, 66, 67, 71, 75, 83, 89, 92, 100, 104, 105, 115, 118, 120, 122, 130, 135, 153, 168
 Space and Information Systems Division, 8, 105
 Rocketdyne Division, 192
 North, Warren J., 13, 14, 192
 Northrop Corporation, 30
 Radioplane Division, 30, 44
 Northrop Ventura, 44, 48, 78, 79, 83, 91
 Nova, 11
 Nuclear radiation dose, 43
See also Bioinstrumentation.

○

OAMS. *See* Orbit attitude and maneuvering system.
 Objectives, 200-202, 224, 227, 235, 237, 239, 245, 251, 254, 259
 Oldeg, Harry W., 19
 O'Loughlin, John C., 75
 Onboard computer, 73, 92
 Onboard navigation system, 16
 computer, 16
 inertial platform, 16
 radar, 16, 260
See also names of each.
 One-man space station, 5, 6
 "Operational and Management Plan for the Gemini Program," 193
 "Operations Executive Group," 204
 Optical rendezvous maneuver, 86, 152
 Oral temperature. *See* Bioinstrumentation.
 Orbit attitude and maneuvering system (OAMS), 26, 29, 65, 80, 109, 120, 123, 127, 130, 136, 146, 155, 157, 176, 189, 192, 201, 202, 211, 235, 261
 25-pound thrusters, 27, 65, 80, 91, 96, 191
 85-pound thrusters, 119
 100-pound thrusters, 27, 94, 108
 Orbital maneuvering, 16, 19, 42, 189, 190, 210, 211, 252

Orbital navigation, 102
 Orbital operations, 7, 8, 19, 222
 ferry, 7
 inspection, 7
 orbital launch, 7
See also Appendix 1.
 Orbital rendezvous, 7, 16, 18, 87, 261
 operational problems, 16
 techniques, 7, 15
 Ordnance Associates, 155
 Oscillograph, 142
 Ostrander, Don R., 7
 Owego, New York, 40
 Owings Mills, Maryland, 184
 Oxidizer, 68, 158, 159, 168, 218, 254
 Oxygen, 33, 98, 229, 233, 252
 supply system, 33, 209, 210, 233

P

Pacific Ocean, 236
 Pad 14, 53
 Pad 19, 12, 46, 47, 61, 187, 223
See also Complex 19.
 Palo Alto, California, 41, 54
 Paoli, Pennsylvania, 26
 Parachute, 87, 161
 18-foot-diameter ring-sail drogue, 45, 47, 78
 84.2-foot-diameter main, Mercury type, 11, 44, 66, 78, 79
 drag, 141
 drogue, 109, 111, 144
 personnel, 32, 51, 78, 141, 181, 184, 185
 pilot, 111
 recovery, 2, 45, 55, 91, 100, 111
 Parachute landing system, 44, 50, 53, 170
 18-foot-diameter ring-sail drogue, 45, 78
 84.2-foot-diameter ring-sail main, 44, 48, 55, 78, 79, 90
 Parachute recovery system, 46, 83, 100, 111, 141, 170, 184, 185
 emergency, 30, 41, 48, 49, 54, 130
 phase III tests, 170
 qualification testing, 48, 50, 55, 78, 90, 106, 107, 129, 140, 144, 170, 181, 184, 185
 Parachute test vehicle (instrumented weight bomb) (PTV), 111, 140
 Paraglider, 19, 27, 30, 32, 43, 44, 46-48, 51, 56, 58, 62, 71, 75, 80, 83, 87, 89, 93, 135
 concept, 16
 deployment hardware, 56
 Paraglider Development Program, 9, 16, 43, 47, 58, 83
 Phase I, 9, 16, 67
 Phase II-A, 16, 17, 30, 41, 48, 51, 55, 56, 66, 67
 Phase II-B, 16, 50, 71, 75
 Phase III, 16
 Paraglider drop tests, 50, 122
 Paraglider landing system, 8, 10, 16, 27, 43, 47, 53, 75, 89, 90, 100
 Paraglider Landing System Coordination Meeting, 47
 Paraglider Landing System Program, 83, 89, 92, 100, 104, 105, 114, 115, 118, 120, 130, 153, 168
 Paraglider recovery system, 47, 100, 135
 Paraglider study, 8
 Paraglider wing, 10, 48, 66, 90
 full-scale, 27-28, 50-51, 118-119
 Pararescue crews, 149
 Parasail landing system, 109, 110
 Pasadena, California, 155
 Patrick Air Force Base, Florida, 122, 217
 PCM telemetry. *See* Pulse-code modulated telemetry.
 PCM (Pulse Code Modulation) Working Group, 79
 PDA. *See* Predelivery Acceptance Tests.
 Pendley, David B., 94, 97, 108

PROJECT GEMINI: A CHRONOLOGY

- Perigee, 63, 244
 Personnel recovery system, functional reliability, 147
 PFRT. *See* Preliminary Flight Rating Tests.
 Philadelphia, Pennsylvania, 84
 Philco Corporation, 54, 84
 Western Development Laboratories, 54
 Phonocardiogram. *See* Bioinstrumentation.
 "Piggyback plan," 52, 96, 108
 Pilot safety, 22
 philosophy, 79
 Pioneer Astro Industries, 121
 Plan X, 98, 208, 211, 213, 229, 232, 235, 239, 240, 243,
 244, 251, 252, 257
 POGO. *See* longitudinal oscillation.
 POGO kit, 126
 fuel surge chamber, 121, 126
 oxidizer standpipe, 126
 Pollux (star), 20
 Postgrade rocket, 10
 Power sources, 1, 21, 157, 158
 batteries, 121, 126, 157, 158
 fuel cells, 21, 121, 126, 157
 solar cells, 21
 See also names of each.
 Power tool, 230, 255
 minimum reaction, 255
 Predelivery Acceptance Tests (PDA), 143, 161
 Preflight automatic checkout equipment, 75
 Preflight checkout, 57, 66, 80, 135
 Preliminary Flight Rating Tests (PFRT), 104, 133, 134,
 138, 158
 Premate Simulated Flight Test, 157, 182, 203
 Premate Systems Tests, 182, 193, 203, 253
 Premate Verification Test, 203
 Prespacecraft Mate Combined System Test, 192
 Prespacecraft Mate Simulated Flight Test, 193
 Prespacecraft Mate Verification Combined Systems
 Test, 239, 246, 252, 257
 Prespacecraft Mate Verification Test, 211, 213, 216, 217,
 232
 Pressure, 169
 Pressure suits, v, 19, 37, 38, 43, 60, 64, 84, 154, 158, 161,
 170, 222
 cover layer, 168
 G2C, 103, 126, 127, 143
 G3C, 127, 154, 190, 196
 G4C, 163, 171, 172, 196, 208
 G5C, 208, 222, 223
 lightweight, 208, 223, 224
 partial wear, quick assembly, 38, 63, 64
 prototypes, advanced full, 38, 63, 64
 See also Suits.
 Pressure vessel, 7, 10
 Preston, G. Merritt, 139
 Procurement and Contracts Division, 154
 Project Apollo, xiii, 62
 Project Development Plan, 13, 14, 21
 Project Dominic, 61
 Project Gemini, xiii, xiv, xv, xvi, 22, 27, 38, 47, 50,
 55, 56, 62, 65, 67, 73, 74, 78, 87, 88, 103, 233
 Project Gemini Management Panel, 61, 62
 Project Mercury, v, xiii, 1-3, 14, 15, 24, 32, 39, 41, 43,
 53, 62, 96, 139
 Project Orbit, 80
 Project Surefire, 220, 229, 230, 239
 Project Surefire Engine Development Task Force, 220
 Propellants, 165, 170, 243, 251, 254
 cryogenic, 103
 storable liquid, 12, 192
 Propulsion and Power Division, 153
 Propulsion systems, v, 21, 29, 34, 58, 61, 68, 233, 247
 Agena D, 54, 62, 187, 213
 Freon-14, 231
 hypergolic, 12, 103
 liquid, 26, 58
 primary, 41, 42, 88, 134, 138, 148, 179, 187, 198,
 205, 213, 230, 232, 235, 240, 247, 251, 252, 255,
 258, 260
 secondary, 42, 134, 138, 143, 148, 179, 198, 205,
 230, 232, 240, 244, 247, 251, 252, 258, 260
 second-stage, 3
 verification test program, 177, 179
 Propulsion test vehicle, 148
 Propulsion test vehicle assembly (PTVA), 134, 138
 Protection, Inc., 38
 PTV. *See* Parachute test vehicle.
 PTVA. *See* Propulsion test vehicle assembly.
 Public affairs, DOD support, 121
 Pulse-code-modulated (PCM) telemetry, 21, 42, 46, 114,
 167, 179
 ground stations, 114, 167, 179
 instrumentation systems, 42
 Pulse-code-modulation system, 42, 63, 85, 145
 Purser, Paul E., 2, 6, 13, 16, 19, 21
 Putnam, William D., xv
 Pyrotechnics, 111, 147, 155, 177, 179, 208, 216, 229, 235,
 241, 243, 251
 Pyrotechnics Installation Building, 217, 250
- Q**
- Qualification flights
 manned, 14, 32
 unmanned, 14, 32, 87
 Qualification tests, 133, 139, 143, 156, 169
 Quality control, 75, 186
- R**
- Radar, 28, 85, 86, 138, 151, 227
 beacon, 60, 211
 program, 112, 113
 Radar transponder, 28, 42, 210
 Radiation belts, 61
 Radiation hazard, 61
 Radiation, Inc., 63
 Radio frequency command system, 63
 Radio Frequency Interference Test, 125, 182
 Radio Frequency Susceptibility Test 142
 Radioplane Division, 30, 44
 Radnofsky, Matthew I., 64
 Range Safety Office, 103
 Range support, 20
 Ranger Launch Directorate, 31
 RCS. *See* Reentry control system.
 Reactant supply system, 33
 Reaction control system, 26, 27, 29, 45, 47, 58, 65, 222
 Real-time computer complex, 84
 Recovery beacon, 98, 144
 Recovery forces, 36, 155
 DOD support, 19
 Recovery support, 20, 121
 Redondo Beach, California, 52
 Reentry, v, 146, 188, 222, 226, 229
 heat, 87, 121
 Reentry control experiments, 3
 Reentry control system (RCS), 26, 27, 91, 96, 101, 108,
 109, 111, 121, 131, 155, 157, 192, 235
 Reentry guidance, 209, 224, 227
 Reentry module, 37, 100, 104, 179
 Reentry system, 2, 32

Reliability, 85, 156
 engine, 54, 90, 113
 testing, 156
 Titan II, 22, 52, 54, 84
 Remote site, 27, 71, 72
 Rendezvous, ii, v, 1, 14, 16, 18, 23, 26, 28, 57, 83, 86, 98,
 142, 151, 201, 209, 210, 222, 224, 227, 228, 230, 237, 248,
 251, 259
 double, 230
 equi-period, 245
 feasibility, 4
 at first apogee, 119, 145, 255
 from above, 230, 245
 from concentric orbits, 148
 phantom, 230
 techniques, 17, 22, 230, 245
 Rendezvous and docking, 15, 18, 42, 57, 185, 192, 215, 219,
 235, 237, 245, 248, 251, 255, 259, 261
 Rendezvous and recovery section, 47, 66, 78, 111, 121,
 129, 130, 144, 145
See also Gemini spacecraft.
 Rendezvous evaluation pod, 41, 42, 58, 87, 151, 204, 209
 Rendezvous experiments, 3, 4, 71, 122, 224
 Rendezvous flight tests, 17, 54, 227
 Rendezvous mission, 5, 14, 17, 18, 20, 23, 58, 63, 81, 86,
 87, 92, 101, 116, 133, 143, 148, 151, 205, 207, 209, 221,
 230, 245
 Rendezvous radar, 28, 41, 58, 85, 161, 210, 222
 flight tests, 157, 210
 system, 29, 112, 113
 Rendezvous targets, 22, 224, 227
 Rerendezvous, 235, 257
 Research and Development Tests, 109
 Research Steering Committee on Manned Space Flight,
 1, 2
 Respiration. *See* Bioinstrumentation.
 Restart capability, 3
 Retrofire, 226, 236, 246, 251, 261
 Retrograde rockets, 10, 34, 44, 45
 Retrorockets, 34, 100, 133, 141, 176, 189, 202
 abort system, 44
 abort test, 99
 qualification tests, 179
 Ritland, O. J., 216
 Riverdale, California, 38
 Rocket motor test, 59
 Rocket Power, Inc., 32
 Rocketdyne Division, 26, 58, 65, 80, 91, 94, 96, 108, 119,
 120, 123, 130, 136, 146, 192
See also North American Aviation, Inc.
 Root, L. E., 220
Rose Knot, USNS, 145
 Rose, James T., 6, 11, 138
 Rosen, Milton W., 7, 16
 Rosenthal, Alfred, 160
 Rubel, John H., 17, 18
 Ryan Aeronautical Company, 8
 Rye Canyon Research Center, 209

S

S-10 (Micrometeorite Collection) experiment, 230, 231
 S-band radar beacon, 38, 51
 Sacramento, California, 26, 54
 Salton Sea, California, 107
 Salton Sea Range, California, 106
 San Diego, California, 8, 14, 168, 208, 229, 240, 246, 251,
 257
 Sanders, Frederick J., 7, 13
 Santa Cruz Test Base, 134, 138, 148, 164, 167, 179, 181
 Sarasota, Florida, 46, 63
 Satellite chaser mission, 153
 Satellite Checkout Building, 217
 Saturn (launch vehicle), 73
 Saturn C-3, 11

Saturn S-IVB, 136
 Scaled-up Mercury spacecraft, 8
 Schirra, Walter M., Jr., 142, 160, 192, 227
 Schneider, William C., 131, 153, 205
 Schriever, Bernard A., 20, 90, 119
 Schultz, Kenneth W., 78
 Schweickart, Russell L., 119, 162
 Scientific Experiments Panel, 68
 Scott, David R., 119, 215, 235
 Scottsdale, Arizona, 34
 Sea urchin eggs, 191
 Seamans, Robert C., Jr., 8, 15, 17, 18, 40, 83, 87, 103,
 113, 114, 135, 137, 192, 216, 217, 222
 Secondary guidance system, 163
 launch vehicle secondary flight control system,
 26, 163
 spacecraft inertial guidance system, 163
 Secondary propulsion system, 23, 158, 159, 163, 199
See also Agena D and Propulsion systems.
 Secretary of Defense, 17, 18, 73, 83, 87
 See, Elliot M., Jr., 60, 75, 106, 184, 219, 234
 Self-contained guidance, 2
 Sequence Compatibility Firing, 120, 127, 128
 Shepard, Alan B., Jr., 234
 Shingles, spacecraft, 100
 Shirts-sleeve environment, 5
 Shoaf, Harry C., 12
 Shroud, 198, 205, 245
 separation, 209, 245
 system, 205
 Shyken, Norman, 164
 Silverstein, Abe, 6, 8
 Simpkinson, Scott H., 44, 177, 217
 Simulated Flight Test, 139, 150, 156, 167, 176, 186, 194,
 196, 202, 203, 205, 208, 211, 215, 219, 226, 243, 248,
 253, 258
 Simulated lunar module, 230, 245
 abort, 230
 rendezvous, 230, 245
 Simulated off-the-pad ejection (SOPE), 49, 51, 59, 77,
 91, 177, 178
 Simulators, 27, 92
 abort, 147
 docking, 85
 flight, 143
 mission, 85
 Simultaneous Launch Demonstration, 205, 215, 219,
 235, 241, 248, 249, 253, 258, 259
 Slayton, Donald K., 73, 102, 106
 Sled tests, 98, 146, 147
 SLV. *See* Atlas standard launch vehicle.
 Smith, Walter D., 15
 Solar cells, 21
 Solar flares, 61
 SOPE. *See* Simulated off-the-pad ejection.
 Space and Information Systems Division, 16, 50, 88,
 114, 118
See also North American Aviation, Inc.
 Space environment, 18, 43, 200, 209
 Space Exploration Program Council, 5
 Space Guidance Center. *See* International Business
 Machines Corporation.
 Space rendezvous, ii, 1, 4,
 Space simulator chamber, 162
 Space station experiment, 153
 Space Systems Division, 18-239, *passim*
See also Air Force Systems Command.
 Space Task Group, 1-15, 138
 Engineering and Contracts Division, 4
 Engineering Division, 6, 9, 12, 13, 15
 Flight Systems Division, 2, 4
 New Projects Panel, 2
 redesignated, 15
 Space Technology Laboratories, Inc., 52, 64, 85, 178

PROJECT GEMINI: A CHRONOLOGY

- Spacecraft. *See* Gemini spacecraft and Mercury spacecraft.
- Spacecraft No. 1, 39, 43, 58, 104, 129
 arrival at AMR, 117
 heatshield, 132
 instrumentation pallets, 101, 117
 mechanical mate, 109, 136
 preflight readiness review, 135
- Spacecraft No. 2, 43, 73, 76, 79, 96, 102, 139, 143, 144, 150, 155, 156, 177, 178, 179
 arrival at Cape Kennedy, 156
 behind schedule, 109
 electrical mate, 164
 guidance and control equipment, 122
 heatshield, 132
 mechanical mate, 163
 systems tests, 129, 142, 177
- Spacecraft No. 3, 58, 80, 102, 143, 144, 145, 155, 156, 163, 179, 181, 182, 191, 192
 delivered to Cape Kennedy, 156, 175
 electrical system modified, 121
 heatshield, 132
 mechanical mate, 182, 184
 systems test, 142
 thrusters static fired, 177
- Spacecraft No. 3A, 80, 161
 thermal qualification test, 161, 171
- Spacecraft No. 4, 84, 126, 155, 181, 186, 189, 191-193
 delivered to Cape Kennedy, 192
 mechanical mate, 194
- Spacecraft No. 5, 96, 126, 131, 146, 155, 161, 188, 191-194, 197, 204, 207, 210
 delivered to Cape Kennedy, 203
 mechanical mate, 204
- Spacecraft No. 6, ii, 146, 154, 156, 188, 192, 194, 202, 203, 207, 208, 211, 213, 217, 224-226, 229
 mechanical mate, 213
- Spacecraft No. 7, ii, 83, 203, 208, 211, 212, 224, 227
 delivered to Cape Kennedy, 216
 electrical mate, 219
 mechanical mate, 219
 passive target for spacecraft 6, 224
- Spacecraft No. 8, 213, 214, 216, 222, 223, 229, 231-233, 235
 delivered to Cape Kennedy, 229
 electrical mate, 233
 weight increase, 133
- Spacecraft No. 9, 233-235, 239-241
 electrical mate, 240
- Spacecraft No. 10, 234, 244, 246, 251, 252
 delivered to Cape Kennedy, 243
 electrical mate, 248
 mechanical mate, 248
- Spacecraft No. 11, 250, 251, 253
 delivered to Cape Kennedy, 251
 electrical mate, 253
 mechanical mate, 253
- Spacecraft No. 12, 258
 delivered to Cape Kennedy, 254
 electrical mate, 258
 mechanical mate, 258
- Spacecraft acceptance review, 150, 156
 Spacecraft atmosphere, 24, 158
 Spacecraft docking bar, 255, 261
 Spacecraft environment, 49
 Spacecraft/GLV Joint Combined Systems Test, 194, 204, 213
 Spacecraft operations coordination meeting, 49
 Spacecraft payload, 12
 Spacecraft systems, 24, 35, 94, 96
 communications, 36
 environmental control, 24
- Spacecraft Systems Tests, 135, 150, 156, 182, 215
 Phase I, 101, 129, 145
 Phase II, 109, 145, 150
- Spacecraft Technology Division, 84
- SSFVT. *See* Subsystems Functional Verification Tests.
- St. Joseph, Michigan, 50
 St. Louis, Missouri, 2, 10, 44, 56, 57, 96, 129, 139
 St. Louis Municipal Airport, 234
 St. Petersburg, Florida, 36
 Stable platform, 4
 Stabilization system, 23
 Stafford, Thomas P., 60, 75, 106, 142, 160, 192, 219, 227, 234, 245, 247
 Stage I, 89, 90
 fuel tank, 76, 81
 oxidizer tank, 68, 81
 Stage II, 89, 90, 116
 fuel tank, 82
 oxidizer tank, 82
 Star chart and holder, 141
 Star tracker, 4
 Static test article, 19, 39, 80
 Static article No. 1, 39, 80
 redesignated spacecraft No. 3A, 80
 Static article No. 2, 53
 Static article No. 3, 80
 Static article No. 4, 80, 150
 Static article No. 4A, 170
 boilerplate No. 5, 129
 Static article No. 5, 158, 185
 open-sea qualification test, 139
 Static article No. 7, 111, 144, 170
 Stationkeeping, 201, 202, 224, 227, 229, 230, 235, 251
 Stead Air Force Base, Nevada, 106
 Stiff, Ray, C., 103
 Stottard, R. L., 83
 Strass, H. Kurt, 1-4
 Studebaker Corporation, 41, 65
 CTL Division, 41, 65
 Subsystems Functional Verification Tests (SSFVT), 94, 132, 135, 149, 151, 155, 164, 181, 183, 192, 193, 202, 203, 215, 226, 234, 241, 248
 Subsystems Reverification Tests 202, 211, 217, 226, 230, 239, 246, 252, 257,
 Subsystems Verification Tests, 105
 Suit temperatures, 24, 139
 Suits, 162, 166, 190, 196, 208
 boots, 84
 gloves, 63, 84
 helmets, 63, 208
 legs, 63
 qualification tests, 169
 sleeves, 63
- Summary of Mercury and Gemini Flights. *See* Appendix 8.
- Sunnyvale, California, 14, 86, 119, 179, 181, 187, 191, 195, 197, 203, 206, 220, 230-233, 239, 240, 243, 246, 248, 252, 253
- Survival equipment, 19, 32
 pack, 99
 postlanding kit, 43, 185
- Sustainer engine, 184, 247
See also Engines.
- Swenson, Loyd S., Jr., xiii, 61
- Symons, John J., 181
- Syracuse, New York, 26
- Systems Assurance Tests, 182, 186, 188, 193, 194, 202, 203, 208, 213, 216, 231
- Systems Evaluation and Development Division, 109, 111
 Landing and Impact System Section, 109

INDEX

Systems Integration Office, 136
See also Gemini Project Office.
 Systems Verification and Combined Interface Tests,
 232

T

T-33 aircraft, 157
 T-38 aircraft, 234
 Tandem actuators, 169
See also Gemini launch vehicle (GLV) 2.
 Tape recorder, 224, 226
 onboard, 46
 telemetry playback, 224, 226, 229
 Target acquisition equipment, 1
 Target docking adapter, 42, 80, 123, 143, 167, 198, 221,
 222, 224
 communications, 222
 electrical, 222
 guidance and control, 222
 instrumentation, 222
 reaction control, 222
 shroud, 123, 222
 Target docking adapter (TDA) No. 1, 198
 Target docking adapter (TDA) No. 5, 235
 Target docking adapter (TDA) No. 6, 251
 Target docking adapter (TDA) No. 7A, 257
 Target launch vehicle (TLV) 5301, 170, 207, 215
 Target launch vehicle (TLV) 5302, 233, 234, 235
 Target launch vehicle (TLV) 5303, 232, 240, 241, 243,
 244
 failure, 244
 Target launch vehicle (TLV) 5304, 240, 241
 Target launch vehicle (TLV) 5305, 246, 247, 248
 TLV for *Gemini X*, 247
 Target launch vehicle (TLV) 5306, 251, 252, 253
 TLV for *Gemini X*, 247
 Target launch vehicle (TLV) 5307, 257, 258
 Target vehicle, 14, 18, 19, 26, 28, 31, 63, 79, 86, 92, 198,
 207
 Agena, 18, 22, 32, 65, 92, 112
 Agena B, 14
 See also names of each.
 Target vehicle docking adapter, 19
 TDA. *See* Target docking adapter.
 Technical Operating Plan, 23
 Technical Services Division, 111
 Telemetry, 19, 42, 216, 224, 226, 229
 equipment, 101, 104
 pulse-code-modulated, 42
 "Ten-point Plan for C & C Equipment," 185
 Testing, 30, 162
 horizontal, 125, 126, 137, 149, 171
 Tether, 84, 230, 255, 257, 261
 Tethered vehicle test, 255, 257, 259, 260, 261
 "The Advanced Gemini Mission Conceptual Study,"
 153
 circumlunar orbiting mission, 153
 lifeboat rescue mission, 153
 lunar orbiting mission, 153
 satellite chaser mission, 153
 space station experiment, 153
 Thiokol Chemical Corporation, 34, 44, 108, 133
 Thomas, James B., 103
 Three-axis reference system (TARS), 26
 Thrust chamber assembly, 26, 94, 108, 120, 123, 131,
 136, 155, 158, 218, 230
 16-pound, 134
 25-pound, 58, 80, 91, 94, 96, 120, 131, 146
 85-pound, 96, 108, 146
 100-pound, 80, 94, 120, 130, 131, 146
 200-pound, 134
 long-life, 146
 Thrust control capability, 3
 Thrust performance requirements, 96

Thrusters, 27, 29, 42, 177, 211, 226, 235, 238
 25-pound, 27, 29, 42, 177, 211, 226, 235, 238
 85-pound, 54, 96
 100-pound, 27, 54, 80, 96
 Thunderstorms, 209
See also Weather.
 "Timber Tower," 98
 Time reference system, 35
 Tindall, Howard W., Jr., 23, 24, 138
 Titan (launch vehicle), 12, 15, 21
 Titan (weapon system), 15
 Titan I, 12, 46
 Titan II, 8, 12, 13, 15, 17-19, 26, 35, 84, 90, 119, 137
 cost, 44
 deficiencies, 125
 weapon system, 8, 17, 22, 52, 68, 76, 90, 93
 See also Launch vehicles.
 Titan II Augmented Engine Improvement Program, 112
 Titan II coordination meeting, 97
 Titan II development and procurement, 21, 32, 77, 90, 93
 flights, 68, 75-77, 86, 93, 108, 116, 119, 121, 125,
 140
 GLV fixes, 90, 93
 Titan II-Gemini Coordination Committee, 84, 90
 Titan II/Gemini launch vehicle, 22
 Titan II/Gemini spacecraft systems integration, 19
 Titan II (intercontinental ballistic missile), 32, 54
 Titan II_{1/2}, 17
 Titan III, 17
 Titanium battery cases, 114
 Titusville, Florida, 217
 TLV. *See* Target launch vehicle.
 Touchdown control, 2
 Tow test vehicle (TTV), 90, 114, 120, 148, 168
 captive-flight test, 90, 153, 168
 Tracking and communications equipment, 160
 Tracking and instrumentation network, 89, 96
 Tracking antenna acquisition aid system, 39, 63
 Tracking network, 71, 72, 180, 211
 DOD support, 121
 Tracking ship, 145
 Training
 egress, 131, 145
 ingress, 131, 145
 See also Astronaut training.
 Training devices, 27
 centrifuge, 27
 docking trainer, 27
 egress trainer, 27
 simulators, 27, 85
 See also Simulators.
 Trajectories and Orbits Coordination Meeting, 61
 Trajectories and Orbits Panel, 138, 145, 157, 187
 Trajectory analysis, 6
 Trajectory control, 23
 Translation and docking trainer, 139, 156
 Transponder, 28, 210, 222
 receiver, 28
 transmitter, 28
 See also Agena target vehicle.
 TTV. *See* Tow test vehicle.
 Tullahoma, Tennessee, 89
 Tulsa, Oklahoma, 123
 Two-man Mercury, 1, 2, 6, 10, 11, 14, 18
 Two-man paraglider trainer, 50

U

UHF voice transceiver, 36
 United States Air Force, 14, 15, 19, 20, 32, 55, 56, 60,
 62, 68, 74, 80, 87, 92, 119, 168, 215, 217, 229, 232, 233,
 239
 Aerospace Medical Research Laboratory
 (6750th), 92

PROJECT GEMINI: A CHRONOLOGY

United States Air Force—Continued
 Air Force 6511th Test Group, 147
 Air Force Missile Test Center, 53
 Air Force School of Aviation Medicine, 49
 Air Force Systems Command, 18, 20, 42, 90, 119, 137, 216
 experiments, 82, 114
 MSC Field Office, 82
 United States Army Corps of Engineers, 47, 54
 United States Army Quartermaster Corps, 50
 Food and Container Institute, 50
 United States Marine Corps, 119
 United States Navy, 60
 experiments, 114, 119
 swimmers, 228
 Aviation Medical Acceleration Laboratory, 102
 University of Houston, 60
 Cullen Auditorium, 60
 Unmanned suborbital ballistic flight, 87
 U.S.S. *Guadalcanal*, 252
 U.S.S. *Guam*, 257
 U.S.S. *Intrepid*, 190, 191
 U.S.S. *Lake Champlain*, 179, 211
 U.S.S. *Leonard Mason*, 237
 U.S.S. *Wasp*, 202, 224, 226, 228, 229, 246, 261

V

Vacuum chamber, 145
 McDonnell, 80
 Van Nuys, California, 30, 63
 Vandenberg Air Force Base, California, 257
 VAT. *See* Vehicle acceptance team.
 Vehicle acceptance team (VAT), 113, 118, 143, 153, 159, 167, 194, 203, 205, 215, 218, 230, 233, 240, 246, 253
 Vehicle Manufacturing and Testing Histories. *See* Appendix 3.
 Vehicle Systems Tests, 187, 188, 195, 197, 203, 216, 240, 246
 Vernier engine, 184, 243, 252
See also Engines.
 Vertical test facility (VTF), 93-95, 104, 118, 126, 132, 135, 137, 142, 149, 183, 193, 232
See also Martin-Baltimore.
 Vibration testing, 86, 109, 114, 145, 150, 156
 Vidya, Inc., 41
 Vogel, Harle, 44
 Voice communications system, 36
 Voice control center, 36
 Voltage Standing Wave Ratio Test, 117, 231
 Volume (spacecraft) constraints, 114
 von Braun, Wernher, 23, 62
 VTF. *See* Vertical test facility.

W

Wallops Island, Virginia, 6
 Walter Kidde and Company, Inc., 32
 Washington, D.C., 5, 8, 15, 82, 186, 192
 Waste management, 50, 141, 169, 181
 Waste storage, 50
 Waste water, 24
 disposal, 24
 storage, 24
 Water dispenser, 50, 141
 Water impact landing tests, 106
 Water landing, 2, 53, 87, 107, 135, 144

Watkins, H. L., 31
 Weather, 230
 electrical storm, 154
 Hurricane Betsy, 213
 Hurricane Cleo, 155
 hurricane conditions, 157
 Hurricane Dora, 155
 Hurricane Ethel, 155
 Hurricane Hilda, 158
 Hurricane Isbell, 159
 lightning strike, 154, 157
 thunderstorms, 209
 wind conditions, 248
 Webb, James E., 17, 40, 44, 53, 73, 74, 83, 217
 Weber Aircraft, 32, 44, 48, 91, 132, 147
 Weight, 79, 85, 114, 136, 182, 220
 constraints, 114
 growth, 133, 182
 Weight and Balance Building, 157
 Weight and balance test, 195
 West Lynn, Massachusetts, 21
 Western Development Laboratories. *See* Philco Corporation.
 Western Military Division. *See* Motorola, Inc.
 Westinghouse Electric Corporation, 28, 113
 Wet Mock Simulated Flight, 127
 Wet Mock Simulated Launch, 139, 186, 195, 219
 GT-2, 164, 165
 GT-3, 186
 GT-4, 196
 GT-5, 205, 206
 GT-6, 215
 Whirlpool Corporation Research Laboratories, 50
 White, Edward H., II, 60, 75, 106, 151, 167, 189, 200-202, 204, 231
 White House, 217
 White room, 46, 212
 clean room, 212
 White Sands Missile Range, 157
 White, Stanley C., 43
 Whitlock, Earl, 43
 Williams, Clifton C., Jr., 119, 239, 248
 Williams, John J., 139
 Williams, Walter C., 24, 42, 61, 62, 103
 Wilson, Louis D., 103
 Wind conditions, 248
See also Weather.
 Wind tunnel tests, 4, 5, 17, 37, 67, 120, 123, 141, 194
 Wiring harness, 104
 Witte, N. F., 58
 Wood, H. W., 96
 Worcester, Massachusetts, 63
 Worldwide Tracking Network. *See* Appendix 4.
 Wright-Patterson Air Force Base, Ohio, 91, 92, 162
 Wyatt, DeMarquis D., 1

Y

Yardley, John F., 6, 217
 Young, John W., 60, 75, 106, 141, 160, 165, 185, 189, 190, 192, 231, 248, 251

Z

Zedekar, Raymond G., 106
 Zero-gravity, 91, 92, 131, 145, 162, 171, 182, 191
 Zimmerman, R. L., 83

THE AUTHORS

James M. Grimwood has been NASA Manned Spacecraft Center Historian since 1962. He was born in Lincoln, Alabama (1922), taking his A.B. degree from Howard College, Birmingham, Alabama (1948), and his M.A. in History from the University of Alabama (1950). He taught history in secondary schools (1950-1952), and at San Antonio College in Texas (1958-1960). Grimwood was an Air Force Historian in South Carolina and Texas (1953-1960). Prior to joining MSC, he was historian with the Army Missile Command, Huntsville, Alabama, preparing histories of Army missile systems. He is a joint author of *This New Ocean: A History of Project Mercury* (1966), and author of *Project Mercury: A Chronology* (1963). He is married and has two children.

Barton C. Hacker has been a Research Associate in the Department of History at the University of Houston since 1966. Born in Chicago, Illinois (1935), he received his B.A. from the University of Chicago (1955). After serving in the U.S. Army he returned to the University of Chicago, receiving his M.A. in History (1962) and Ph. D. (1968). Before coming to Houston he taught the history of science at the University of Chicago (1965-1966). In addition to several papers presented at scholarly meetings, he is the author of "Greek Catapults and Catapult Technology: Science, Technology, and War in the Ancient World," *Technology and Culture*, IX (1968), 34-50. He is married and has one son.

Peter J. Vorzimmer has been Associate Professor of History at Temple University since 1967. Born in New York City in 1937, he received a B.A. in Zoology from the University of California, Santa Barbara (1958), and his Diploma in History and Philosophy of Science (1959) and Ph. D. in History of Science from the University of Cambridge (1963). He was Assistant Professor of History at the University of Washington (1963-1966), and Research Associate in the Department of History at the University of Houston (1966-1967). He is married and has two children.

NASA HISTORICAL PUBLICATIONS

HISTORIES:

MANAGEMENT HISTORY SERIES

- ROBERT L. ROEHOLT, *An Administrative History of NASA, 1958-1963*, NASA SP-4101, 1966, \$4.00.*

PROGRAM HISTORY SERIES

- LOYD S. SWENSON, JR., JAMES M. GRIMWOOD, and CHARLES C. ALEXANDER, *This New Ocean: A History of Project Mercury*, NASA SP-4201, 1966, \$5.50.
- CONSTANCE MCL. GREEN and MILTON LOMASK, *Vanguard: A History* (1969).

CENTER HISTORY SERIES

- ALFRED ROSENTHAL, *Venture Into Space: Early Years of Goddard Space Flight Center*, NASA SP-4301, 1968, \$2.50.

HISTORICAL STUDIES:

- EUGENE M. EMME (ED.), *History of Rocket Technology*, special issue of *Technology and Culture* (Fall 1963); augmented and published by Society for the History of Technology (Detroit: Wayne State University, 1964).
- MAE MILLS LINK, *Space Medicine in Project Mercury*, NASA SP-4003, 1965, \$1.00.
- *Historical Sketch of NASA*, NASA EP-29, 1965 (Out of Print).

CHRONOLOGIES:

- *Aeronautics and Astronautics: An American Chronology of Science and Technology in the Exploration of Space, 1915-1960*, compiled by Eugene M. Emme, Washington: NASA, 1961 (Out of Print).
- *Aeronautical and Astronautical Events of 1961*, published by the House Committee on Science and Astronautics, 1962 (Out of Print).
- *Astronautical and Aeronautical Events of 1962*, published by the House Committee on Science and Astronautics, 1963, \$1.00.
- *Astronautics and Aeronautics, 1963*, NASA SP-4004, 1964, \$1.75.
- *Astronautics and Aeronautics, 1964*, NASA SP-4005, 1965, \$1.75.
- *Astronautics and Aeronautics, 1965*, NASA SP-4006, 1966, \$2.25.
- *Astronautics and Aeronautics, 1966*, NASA SP-4007, 1967, \$1.50.
- *Astronautics and Aeronautics, 1967*, NASA SP-4008 (1968).
- *Project Mercury: A Chronology*, by James M. Grimwood, NASA SP-4001, 1963, \$1.50.
- *The Apollo Spacecraft: A Chronology, Vol. I, through November 7, 1962*, by Ivan D. Ertel and Mary L. Morse, NASA SP-4009 (1969).

*All titles with prices can be ordered from the Superintendent of Documents, Government Printing Office, Washington, D.C. 20402.